

DOCENTE

CURSO: INSTALACION Y MANEJO DE REDES  
CON NETWARE DE NOVELL

FECHA: 3 AL 14 DE NOVIEMBRE DE 1992.  
LUNES A VIERNES DE  
17 A 21 HRS.

		DOMINIO DEL TEMA	EFICIENCIA EN EL USO DE AYUDAS AUDIOVISUALES	MANTENIMIENTO DEL INTERES (COMUNICACION CON LOS ASISTENTES AMENIDAD, FACILIDAD DE EXPRESION)	PUNTUALIDAD	PROMEDIO
1.-	ING. JUAN F. MAGAÑA CARRILLO					
2.-	ING. SAUL MAGAÑA CISNEROS					
3.-						
4.-						
5.-						
EVALUACION TOTAL						

ESCALA DE EVALUACION: 1 A 10

CURSO: INSTALACION Y MANEJO DE REDES  
CON NETWARE DE NOVELL

FECHA: 3 AL 14 DE NOVIEMBRE DE 1992.  
LUNES A VIERNES DE  
17 A 21 HRS.

		ORGANIZACION Y DESARROLLO DEL TEMA	GRADO DE PROFUNDIDAD LOGRADO EN EL TEMA	GRADO DE ACTUALIZACION LOGRADO EN EL TEMA	UTILIDAD PRACTICA DEL TEMA	PROMEDIO
	T E M A					
1.-	INTRODUCCION					
2.-	CARACTERISTICAS DE LAS VERSIONES DE NETWARE					
3.-	INSTALACION DE HARDWARE					
4.-	INSTALACION DEL SISTEMA OPERATIVO					
5.-	INSTALACION DE ELEMENTOS ESPECIALES					
6.-	EL SUPERVISOR Y SUS FUNCIONES EN NETWARE					
7.-	SESIONES DE TALLER EN CADA TITULO					
8.-						
9.-						
10.						
11.						

EVALUACION TOTAL

ESCALA DE EVALUACION: 1 A 10

## EVALUACION DEL CURSO

C O N C E P T O		
1.	APLICACION INMEDIATA DE LOS CONCEPTOS EXPUESTOS	
2.	CLARIDAD CON QUE SE EXPUSIERON LOS TEMAS	
3.	GRADO DE ACTUALIZACION LOGRADO EN EL CURSO	
4.	CUMPLIMIENTO DE LOS OBJETIVOS DEL CURSO	
5.	CONTINUIDAD EN LOS TEMAS DEL CURSO	
6.	CALIDAD DE LAS NOTAS DEL CURSO	
7.	GRADO DE MOTIVACION LOGRADO EN EL CURSO	
EVALUACION TOTAL		

ESCALA DE EVALUACION: 1 A 10

6.- ¿Qué cursos le gustaría que ofreciera la División de Educación Continua?

\_\_\_\_\_  
\_\_\_\_\_  
\_\_\_\_\_

7.- La coordinación académica fué:

EXCELENTE

BUENA

REGULAR

MALA

8.- Si está interesado en tomar algún curso INTENSIVO ¿Cuál es el horario más conveniente para usted?

LUNES A VIERNES  
DE 9 a 13 H. Y  
DE 14 A 18 H.  
(CON COMIDAD)

LUNES A  
VIERNES DE  
17 a 21 H.

LUNES A MIERCOLES  
Y VIERNES DE  
18 A 21 H.

MARTES Y JUEVES  
DE 18 A 21 H.

VIERNES DE 17 A 21 H.  
SABADOS DE 9 A 14 H.

VIERNES DE 17 A 21 H.  
SABADOS DE 9 A 13 H.  
DE 14 A 18 H.

OTRO

9.- ¿Qué servicios adicionales desearía que tuviese la División de Educación Continua, para los asistentes?

\_\_\_\_\_  
\_\_\_\_\_  
\_\_\_\_\_

10.- Otras sugerencias:

\_\_\_\_\_  
\_\_\_\_\_  
\_\_\_\_\_

DEL 3 DE NOVIEMBRE AL 14 DE NOVIEMBRE DE 1992

1.-MAURICIO ARCE OROZCO  
JEFE DE UNIDAD  
DIR.GRAL. DE PLANEACION UNAM.

UNIVERSIDAD NO. 3000  
COYOACAN

TEL. 6 22 60 71 6 06 96 86

GRAL. LOERA NO. 27 INT. 2  
DANIEL GARZA MIGUEL HIDALGO  
11830 MEXICO, D.F.  
TEL. 2 77 78 34

2.-AQUILES BERILLA DUARTE  
SUPERVISOR DE SISTEMAS  
S.C.T. FIDEICOMISO CONACAL

DR. VERTIZ NO. 1245

TEL. 6 04 98 52

SUR 65-A NO. 3231  
VIADUCTO PIEDAD IZTACALCO  
08200 MEXICO, D.F.  
TEL. 5 19 83 46

3.-ORALIA CARRILLO ROMERO  
TECNOCO ACADEMICO  
UNAM.

MATIAS ROMERO NO. 1220  
DEL VALLE BENITO JUAREZ  
03100 MEXICO, D.F.  
TEL. 6 04 40 29

5 DE FEBRERO NO. 40  
SAN ANDRES TOTOLTEPEC TLALPAN  
14400 MEXICO, D.F.  
TEL. 8 49 00 07

4.-LUIS ESCOBEDO RODRIGUEZ  
LIDER DE PROYECTO  
ASOC. DE EMPRESAS EN INFORMATICA,S.A.

BENJAMIN FRANKLIN NO. 205  
MIGUEL HIDALGO  
MEXICO, D.F.  
TEL. 5 15 02 93

GUSTAVO BAZ NO. 13 INT.11  
NAUCALPAN CENTRO.  
53000 EDO. DE MEXICO.

5.-MARIA EUGENIA FLORES MARTINEZ  
INGENIERO DE SISTEMAS  
MAI DE MEXICO

MIXCOAC NO. 889 - 6o.PISO  
MIXCOAC BENITO JUAREZ  
03910 MEXICO, D.F.  
TEL. 5 43 70 77

BUGAMBILIA NO. 32  
COYOACAN  
04370 MEXICO, D.F.  
TEL. 5 49 17 28

6.-ALBERTO FLORES VALENZUELA  
ANALISTA DE SISTEMAS  
PETROLEOS MEXICANOS

EL NACIONAL NO. 216 PISO 15  
NUEVA ANZURES MIGUEL HIDALGO  
11590 MEXICO, D.F.  
TEL. 2 03 01 69

PORTAL NO. 26  
PASTORES  
53340 NAUCALPAN, EDO. DE MEXICO.  
TEL. 5 45 88 83

7.-ESMARAGDO HUERTA DIAZ CONTI  
COORD. DE MANTENIMIENTO  
DESITEL TECNOLOGIA Y SISTEMAS, SA.DE CV.

FELIX CUEVAS NO. 411  
DEL VALLE BENITO JUAREZ  
03100 MEXICO, D.F.  
TEL. 5 24 49 75

8.-MARIA EUGENIA MENDEZ CONTRERAS  
TECNICO ACADEMICO  
UNAM.

MATIAS ROMERO NO. 1220  
DEL VALLE BENITO JUAREZ  
03100 MEXICO, D.F.  
TEL. 6 04 40 24

9.-JAVIER FRANCISCO PEREZ PEREZ  
ACADEMICO  
UNAM.

C.U. CIRCUITO INTERIOR  
COYOACAN  
MEXICO, D.F.  
TEL. 6 22 16 06

10.-DANIEL EDUARDO QUINTANA FRANCO  
LIDER DE PROYECTO  
GRUPO ALUMINIO ALMEXA

VIA MORELOS NO. 347  
STA. MA. TULPETLAC  
EDO. DE MEXICO  
TEL. 7 76 45 99

11.-FÉLIX DE JESUS ZARATE TORRES  
ANALISTA  
PETROLEOS MEXICANOS

EJERCITO NACIONAL NO. 216 PISO 15  
ANZURES MIGUEL HIDALGO  
11590 MEXICO, D.F.  
TEL. 5 45 88 83

ZACAMIXTLE NO. 120  
PETROLERA AZCAPOTZALCO  
02480 MEXICO, D.F.  
TEL. 5 61 40 48

ESTRELLA NO. 20 EDIFICIO D DEPTO 501  
SAN JUAN XALPA IZTAPALAPA  
09850 MEXICO, D.F.

PLAZA VIZCAINAS NO. 24  
IZTAPALAPA  
09020 MEXICO, D.F.  
TEL. 7 58 51 61

OTE. 257 NO. 140 CASA 4A  
AGRICOLA ORIENTAL IZTACALCO  
08500 MEXICO, D.F.  
TEL. 5 58 00 92

CAMINO REAL MZ. 75A L.24 SECC.ALAMEDA  
FRACC. OJO DE AGUA  
55770 EDO. DE MEXICO.  
TEL. 91 595 8 12 76

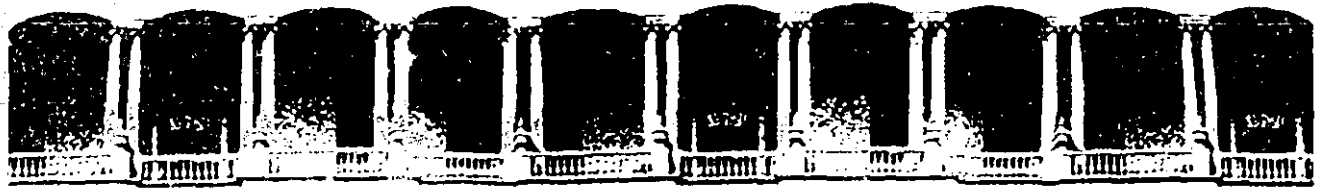

**FACULTAD DE INGENIERIA U.N.A.M.  
DIVISION DE EDUCACION CONTINUA**

**INSTALACION Y MANEJO DE REDES (LAN) CON  
NETWARE DE NOVELL (PARTE III)**

**MATERIAL DIDACTICO**

**NOVIEMBRE, 1992.**



# INTRODUCCION



## P R E S E N T A C I O N

Cada día aumenta el número de usuarios de las REDES (LAN) de microcomputadoras, merced a que este recurso de actualidad ofrece al usuario la coyuntura para compartir y administrar los recursos costosos que se requieren en cualquier área de cómputo.

Si bien hace unos seis años se inició un movimiento tendencioso hacia las REDES, ahora el uso de éstas son una realidad y una necesidad de primer orden; debido a ello, la industria del software tratando de ganar el mercado internacional, se ha dedicado a fabricar Sistemas Operativos para REDES que ofrecen al usuario diferentes atributos y un rendimiento óptimo.

Entre los distintos productos, por su popularidad y flexibilidad destaca Netware de Novell que desde su versión basada en el 286 y liberada en junio 1985, ha sido el líder de la industria y aseveran algunos observadores que tiene el 67% del mercado actual. Este fenómeno es el índice del usuario con el que está definiendo como Sistema Operativo estandar a Netware, a tal grado que tanto la industria del software como la del hardware, están alineando sus productos para redes (hojas de cálculo, manejadores de bases de datos, procesadores de textos, compuedición, tarjetas etc.), con este popular sistema operativo.

El uso actual de las redes con este sistema operativo es tan común, que se imponía diseñar este curso en el que se verá desde Netware ELS I de bajo nivel (cuatro usuarios), ELS II (ocho usuarios), Advance Netware V.2.15 (100 usuarios) con versiones SFT, (Sistema Tolerante a Fallas) y Netware 386 recientemente liberado. Obviamente se tratará sobre las técnicas avanzadas que brinda la gama de Netware como: File Caching, Disk Cache, Directory Hashing, Elevator Seeking, TTS (rastreo de transacciones), monitoreo de UPS (unidades de energía ininterrumpida), Disk Duplexing (duplicado de discos), Disk Mirror (discos en espejo, etc.), que incorporó Novell en el diseño de Netware a efecto de optimizar el rendimiento del Sistema Operativo y por ende el de la RED.

**O B J E T I V O S . -**

Lograr que los usuarios de las REDES: Ejecutivos, Funcionarios, Supervisores, Desarrolladores, Distribuidores y técnicos en general, después de este curso conozcan su sistema operativo de RED con más detalle, y puedan generarlo e instalarlo sin ningún problema.

Dar a los participantes en general, los parámetros y puntos clave necesarios a evaluar, que les permitan optar con seguridad por la versión más conveniente para sus aplicaciones.

Tratar con base en este curso, que los asistentes logren en bien propio y de sus organismos, dominar las herramientas lógicas que se estudiarán, en aras de la tan necesaria productividad.

**A QUIEN VA DIRIGIDO . -**

A Ejecutivos, Funcionarios y técnicos que por sus necesidades profesionales estén involucrados con las REDES de Micros y deseen elevar su gradiente en este campo de los Sistemas Operativos para RED.

Se requiere que los participantes tengan buen nivel en microcomputación con manejo amplio de MS-DOS y haber tomado sin ser limitante, el Curso Introductorio de REDES (LAN) DE MICROS o equivalente.

**P R O F E S O R E S :**

Ing. Saúl S. Magaña C.

Ing. Irwing Castellanos W.

Ing. Juan Carlos Magaña C.

Ing. M. Antonio Domínguez T.

Ing. Juan F. Magaña Carrillo

**TEMARIO.-**

- 1).- **INTRODUCCION**
  - 1.1.- Revisión de conceptos
  - 1.2.- Interacción de Sistemas Operativos
  - 1.3.- Mapas de Memoria
  - 1.4.- Componentes del Sistema Operativo de RED
- 3).- **Características de las versiones de NETWARE**
  - 3.1.- ELS I, ELS II
  - 3.2.- Versiones 286 SFT
  - 3.3.- Netware 386
- 4).- **Instalación del Hardware**
  - 4.1.- Características
  - 4.2.- Configuración
  - 4.3.- Instalación física y pruebas
- 5).- **Instalación del Sistema Operativo.**
  - 5.1.- Generación del "SHELL" para Est. de trabajo
  - 5.2.- Generación e Instalación del Sistema Operativo en el Servidor
- 6).- **Instalación de Elementos Especiales**
  - 6.1.- Puentes, Gateways, UPS.
  - 6.2.- Discos en Espejo, Discos duplicados
  - 6.3.- Otros
- 7).- **El Supervisor y sus funciones en NETWARE**
  - 7.1.- Usuarios, Grupos de usuarios, Altas, Bajas
  - 7.2.- Atributos y Seguridades
  - 7.3.- Instalación de Aplicaciones
  - 7.4.- Configuración y mantenimiento de colas de impresión
  - 7.5.- Mantenimiento general de la red
- 8).- **Sesiones de taller en cada título.**

# **COMPONENTES NECESARIOS PARA UNA RED LOCAL**

**Los componentes que forman una red son :**

- 1. La estación de red**
- 2. El server o servidor de la red.**
- 3. El controlador de la red en cada estación o server**
- 4. Medio de conexión**
- 5. Programas de red**

## CARACTERISTICAS DEL SERVER

- El Server es el equipo centralizado que contiene todos los recursos a compartir
- Controla el flujo de información de cada usuario de la red.
- Dependiendo del Sistema Operativo que se utilice en una red local puede utilizar más de un server si se desean dividir los recursos.
- Hay dos tipos de Servers :
  - A. Server Dedicado
  - B. Server No Dedicado

# EL MICROPROCESADOR

# EL SERVER

Cerebro de la Red

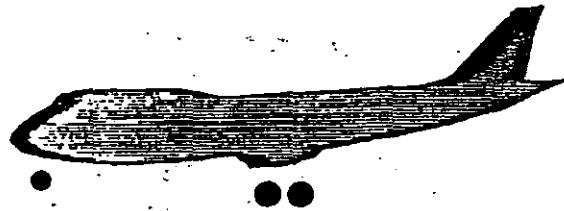

80286



80386SX

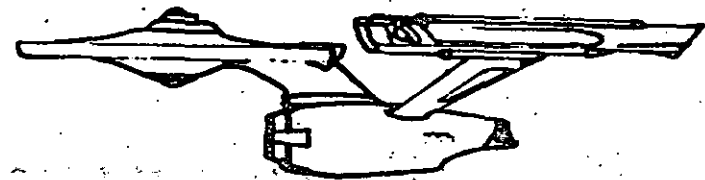

80386



# LA MEMORIA

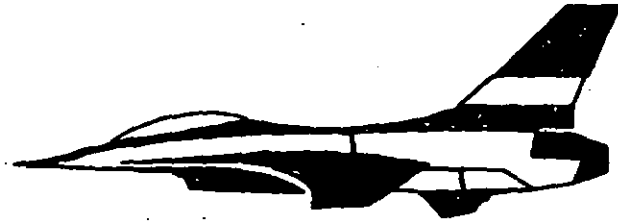

PROCESADOR

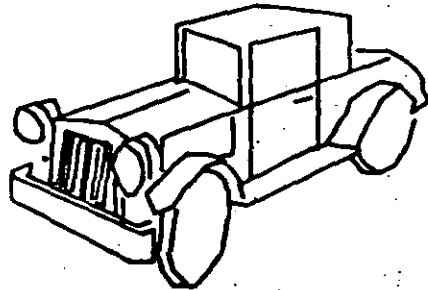

MEMORIA

# EL SERVER

Cerebro de la Red

## ESTRATEGIAS

Simple DRAMS

Simple SRAMS

Interleaved RAM

Page Mode

Caching



# UNIDADES DE DISCO

# EL SERVER

Cerebro de la Red

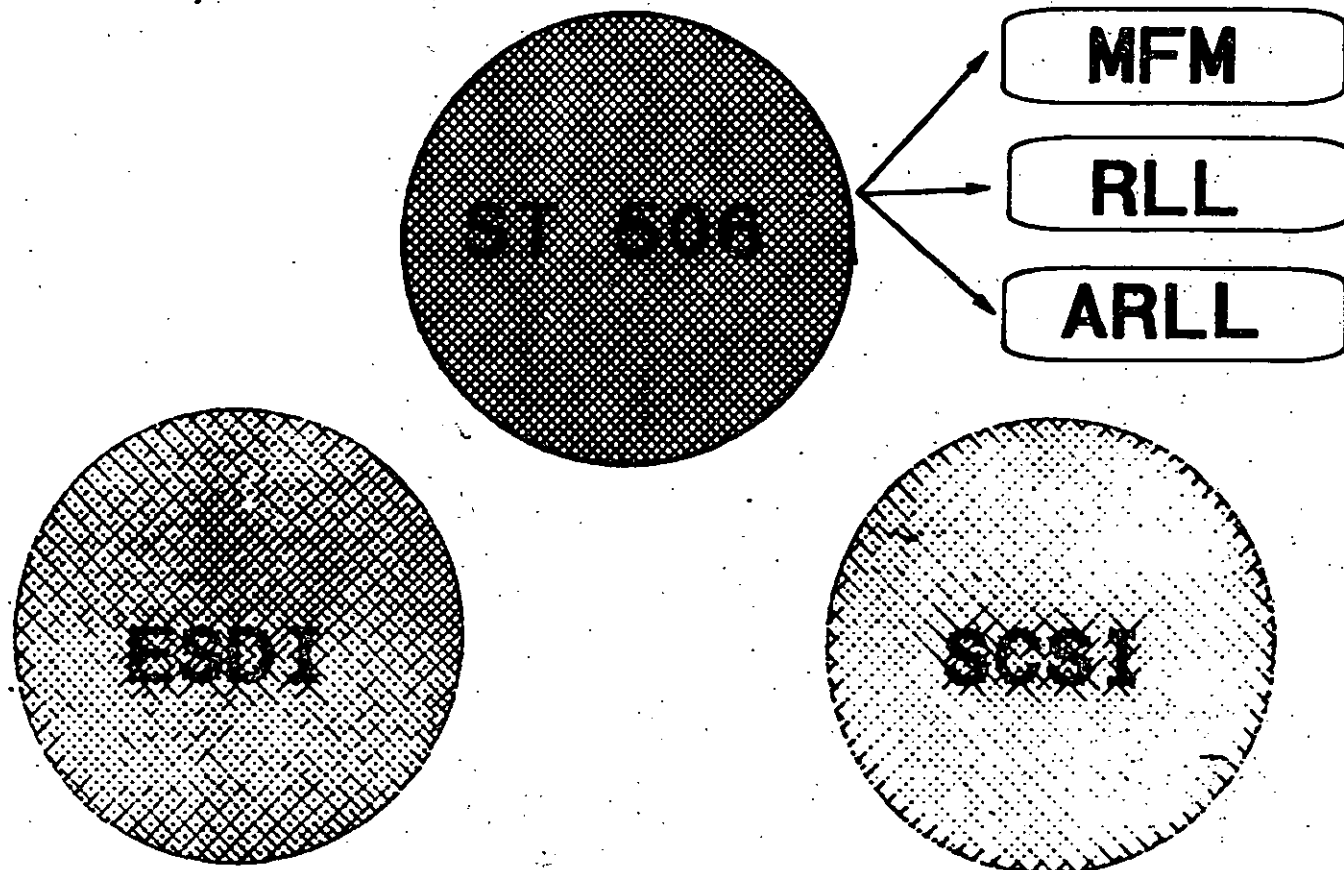

## TIPOS DE CONTROLADORES





# CONCEPTOS GENERALES

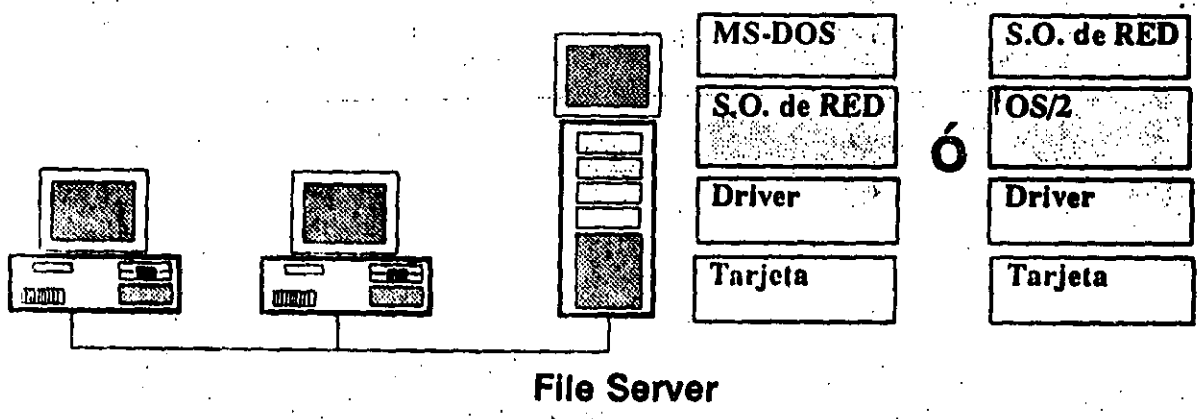

Software  
 Hardware

apuntes

# CONCEPTOS GENERALES

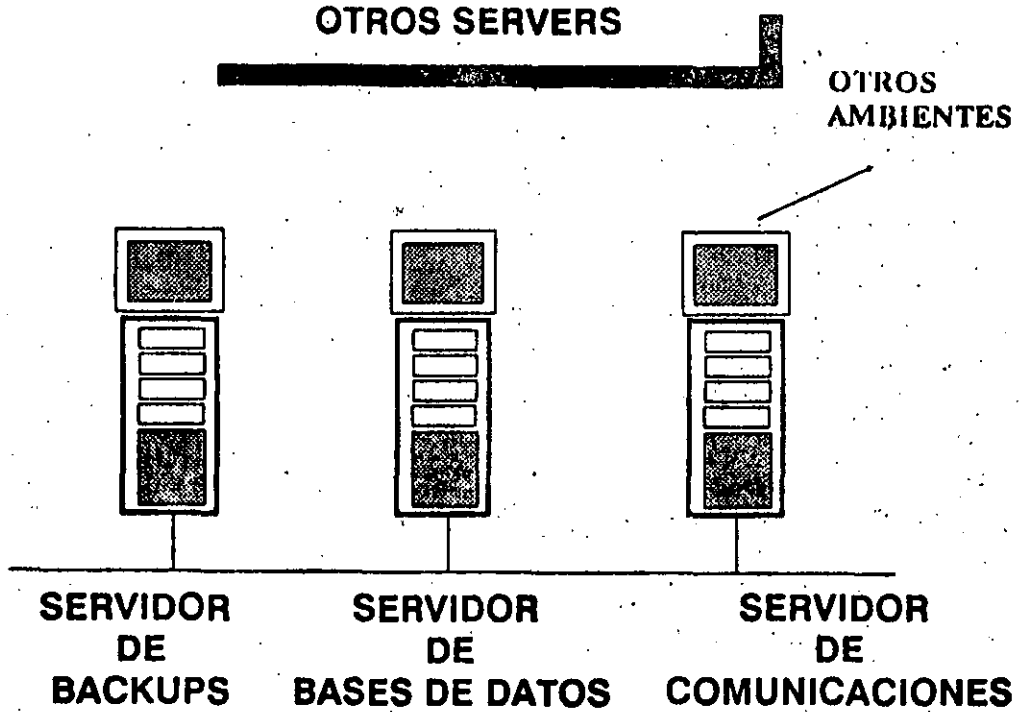

apuntes

# CONCEPTOS GENERALES





## TERMINOLOGIA

Estación de Trabajo  
Estación de Trabajo sin Diskette  
Shell  
Driver

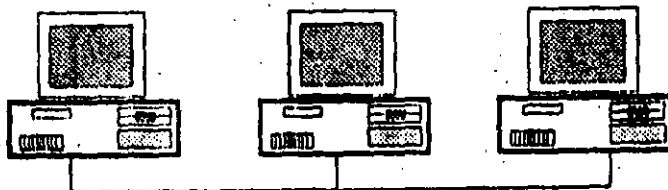
- Aplicaciones
- MS-DOS y Shell
- Tarjeta



Estación de Trabajo

-  Software
-  Hardware

apuntes



## CARACTERISTICAS DE UNA ESTACION DE TRABAJO

- La Estación de Trabajo puede ser de diferentes configuraciones (XT, AT)
- La Estación de red no contiene ningún recurso que se pueda compartir con la red
- La Estación la utiliza un usuario de red que desea acceder los recursos del Server
- Puede utilizarse como un equipo totalmente separado de la red si así se desea

## CARACTERÍSTICAS DE LAS REDES DE ÁREA LOCAL

De lo anteriormente expuesto pueden deducirse algunas de las características más significativas de las redes de área local. Entre ellas podríamos destacar:

### *Área Moderada*

El espacio físico que abarca una red local suele estar limitado a un edificio o un conjunto de éstos, pudiendo variar la distancia máxima entre sus nodos desde una decena de metros hasta varios kilómetros.

### *Canal Dedicado*

El medio físico (canal) está exclusivamente dedicado a la comunicación que se produce entre las distintas estaciones de la red local. Existirá gran variedad de calidad y precio entre estos medios, siendo los más económicos los de par de hilos trenzados, mientras que los más complejos serán los cables coaxiales apantallados con protecciones metálicas.

### *Baja tasa de errores*

Debido a las características de especial dedicación del medio y a las distancias relativamente cortas en que se produce la comunicación, los errores serán escasos y fácilmente corregibles. En las redes locales industriales la fiabilidad de la transmisión de la información será un factor decisivo para garantizar la calidad de funcionamiento.

### *Costo reducido*

Uno de las principales objetivos que se barajan al planificar una red local es que el costo de conexión entre los distintos sistemas informáticos sea notablemente inferior al precio del sistema informático propiamente dicho.

### *Modularidad*

Las redes locales deberán ser muy flexibles, tanto para la incorporación de nuevos elementos como para su supresión. La razón estriba en que el entorno de aplicación de las redes locales suele ser muy cambiante. No obstante, cuando requieren la instalación de un cable de los denominados rígidos, esta flexibilidad ha de ser en parte sacrificada por el propio costo de la instalación.

### *Posibilidad de interconexión de equipos heterogéneos*

Con frecuencia, en una oficina o planta de fabricación, debido fundamentalmente a la rapidez con que quedan obsoletos muchos equipos, éstos suelen proceder de una amplia gama de proveedores, siendo necesario que la red local sea capaz de solucionar el problema de interconexión de todos ellos. Esta característica está directamente relacionada con la necesidad de normalización que será comentada en capítulos posteriores.



**CARACTERISTICAS DE LAS  
VERSIONES DE  
NETWARE**

\*\*\*

## NOVELL NETWARE

Los primeros sistemas operativos para redes aparecen a principios de 1980, los cuales eran sistemas sencillos que sólo compartían recursos entre PC'S. Mientras la demanda de redes empezó a crecer en el mercado, se le agregaron más características a los sistemas más poderosos y funcionales.

La industria de la computación ha experimentado diferentes etapas importantes.

- La primera fue en 1960 con el florecimiento de los "Mainframes" debido al diseño de los transistores.

- La segunda se realiza a mediados de 1970, con la aparición de los circuitos integrados lo que permitió diseñar computadoras pequeñas y económicas, esta fue la época de las microcomputadoras.

- La tercera, está considerada como la época de las computadoras personales desarrolladas gracias a la invención del microprocesador.

Dichas computadoras están basadas en un sólo circuito integrado, su realización es a principios de 1980.

Mientras la popularidad de las computadoras personales crecía, la necesidad de interconectarlas también. Así es como nace el concepto de Red local (LAN) dentro de la industria de la computación.

Se ha fabricado un sistema operativo para redes (LAN'S) más popular, "NETWARE".

Este es introducido por primera vez en el mercado en el año de 1983 como Novell-NETWARE, ya que es un sistema operativo para redes más conocido en el mercado. Novell NETWARE, el cual tiene una base instalada sobre 3.5 millones de usuarios 350,000 NETWARES vendidos y el mayor porcentaje del mercado compartido de redes.

Estadísticas realizadas por "Fortune" en 1988 nos muestran que Novell tiene la mayor base instalada en Sistema Operativo (fig. 1) para red (LAN'S), y las perspectivas para 1989 son incrementar el porcentaje de esa base instalada (fig. 2).

# Sistemas Operativos de Red Instalados

017

Empresas "Fortune 1000" - Entrevistas de Junio del 88

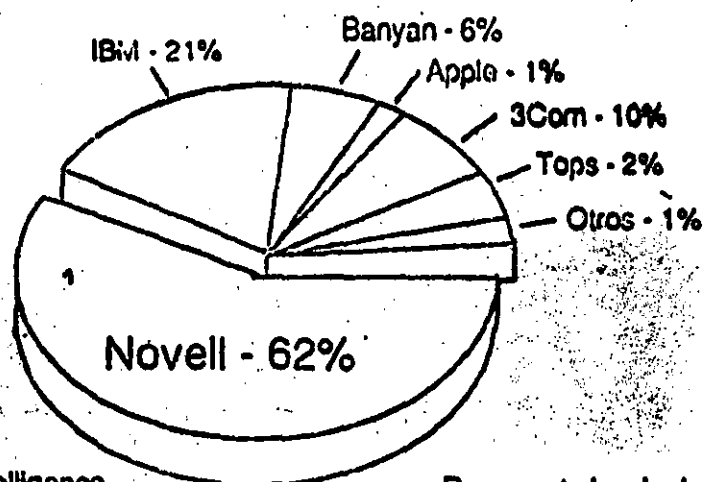

Fuente: Computer Intelligence

Porcentaje de las Instalaciones

Fig. 1

# Sistemas Operativos de Red Planeados

Empresas "Fortune 1000" - Entrevistas de Junio del 88

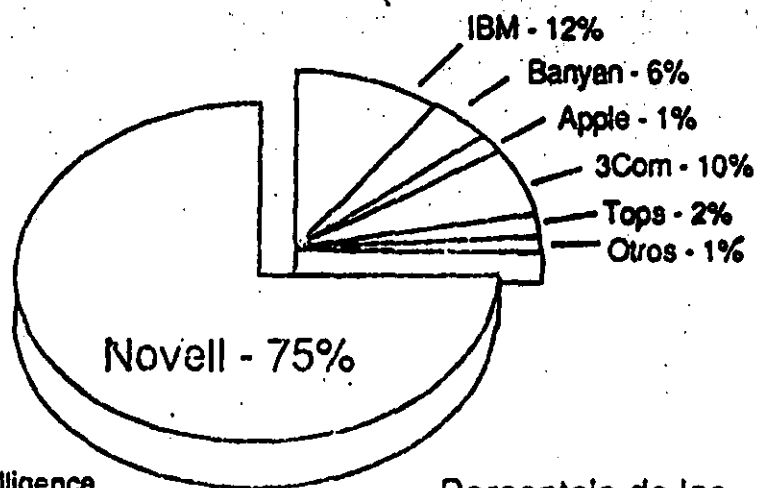

Fuente: Computer Intelligence

Porcentaje de las Instalaciones

Fig. 2



Novell ha tenido un crecimiento impresionante de 1985 a 1988, tal y como lo muestra la gráfica de su resultado de operaciones (fig. 3) y (fig. 4).

## Novell - Resultado de Operaciones

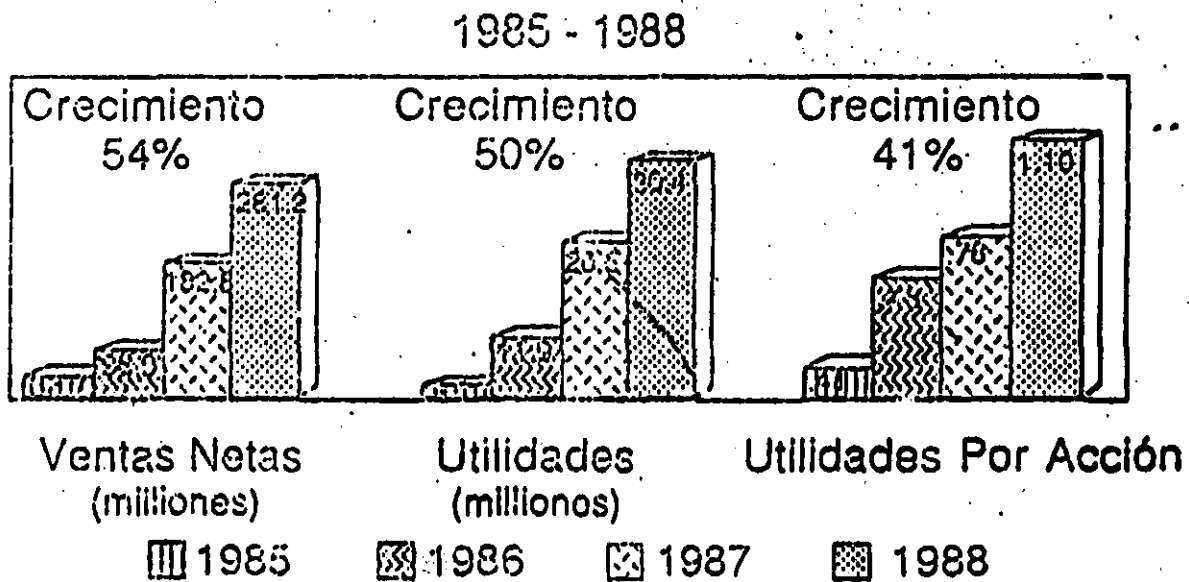

Fig. 3

## Netware - Sistemas Instalados

---

- 300.000 servidores de archivo
- 10.000 servidores adicionales por mes
- 3 millones de usuarios

Fig. 4

La estrategia que se ha seguido para la instalación de un sistema operativo es el siguiente:

- \* Independencia de Interfaz.
- \* Independencia de Protocolo.
- \* Independencia de S.O. de la estación de trabajo.
- \* Ser el Standar de Standares del futuro.
- \* Fig. 5.

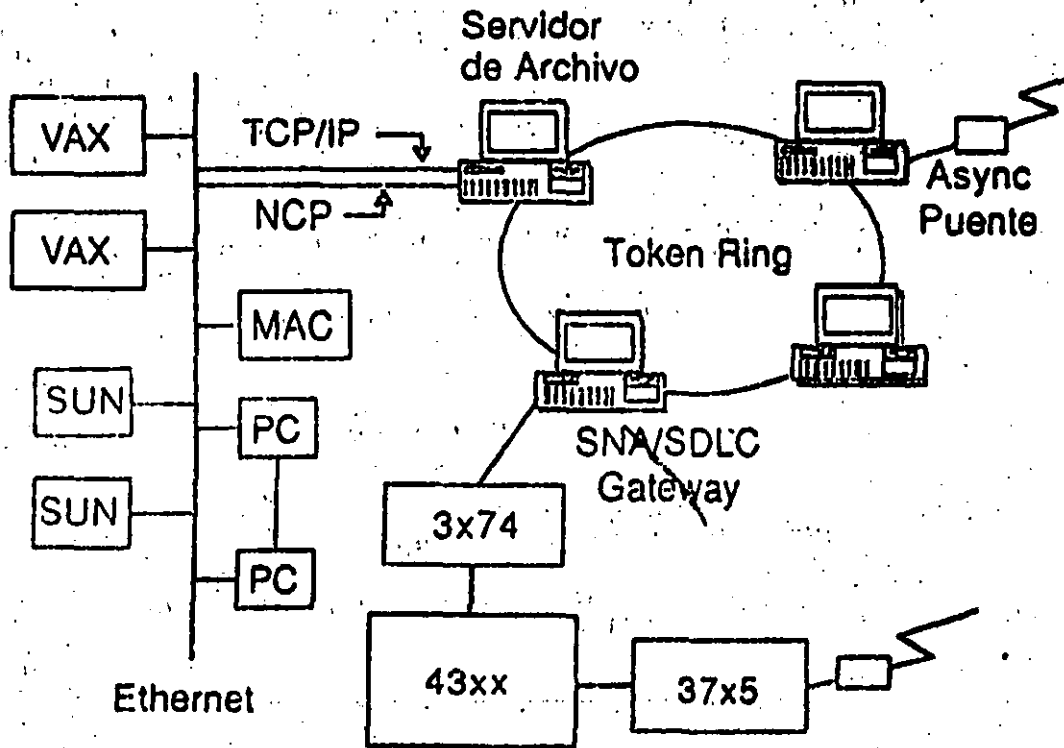

Fig. 5

## NETWARE

Los elementos de una red, son los que ha continuación se describen:

- Servidor de Archivos (FS).
- Estaciones de Trabajo.
- Dispositivos Periféricos (LP, MT, etc).
- Tarjetas de interfaz (ETHERNET, T, R, HRC).
- Cables.
- Sistema Operativo.
- Fig. 6.

El sistema operativo para red es el programa responsable de:

- Administrar los recursos compartidos.
- Manejar las comunicaciones entre las PC'S.
- Garantizar la integridad de la información.

Esto no lo puede hacer el Sistema Operativo de la estación de trabajo, puesto que su origen no está diseñado para estas tareas: esta es la razón por la cual debe haber un sistema operativo de red.

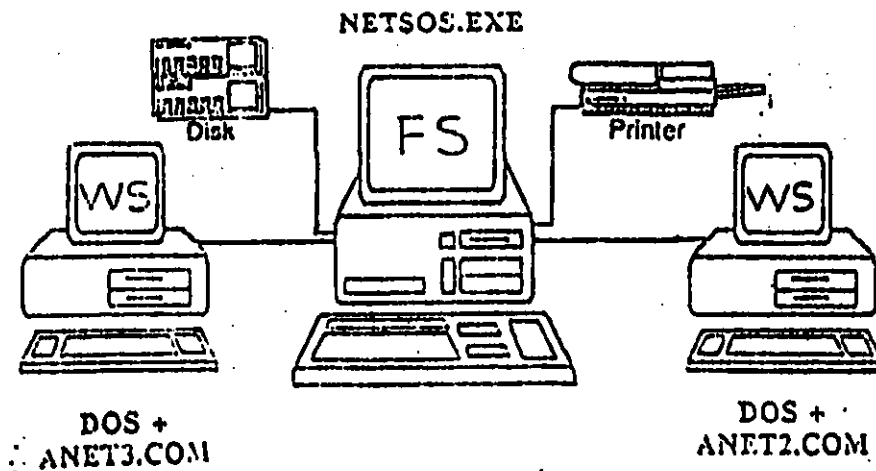

Fig. 6

## SISTEMA OPERATIVO DE RED

### NETWARE

Es el sistema operativo para redes más sofisticado y funcional en la actualidad, es introducido por primera vez en 1983. NETWARE fué uno de los primeros sistemas operativos de red en el mercado desde entonces ha sido perfeccionado por Novell.

### FUNCIONAMIENTO

El sistema operativo NETWARE es instalado en una Microcomputadora sobre el disco duro, convirtiéndose esta Micro es lo que se conoce como servidor de archivos, este se encargará de controlar y compartir los recursos de la red tales como:

- Disco duro.
- Datos.
- Aplicaciones.
- Periféricos.
- Otros servicios.
- Fig. 7.

**Datos.-** Es la información de suma importancia para los usuarios de la red, con la cual realizarán su trabajo diario.

**Aplicaciones.-** Son programas desarrollados por diferentes fabricantes, en los que se permite al usuario manejar y configurar sus datos explotando los recursos de su máquina de una manera eficiente.

**Periféricos.-** Estos dispositivos son tales como impresoras, discos duros, unidades de respaldo en cintas, servidores de comunicación.

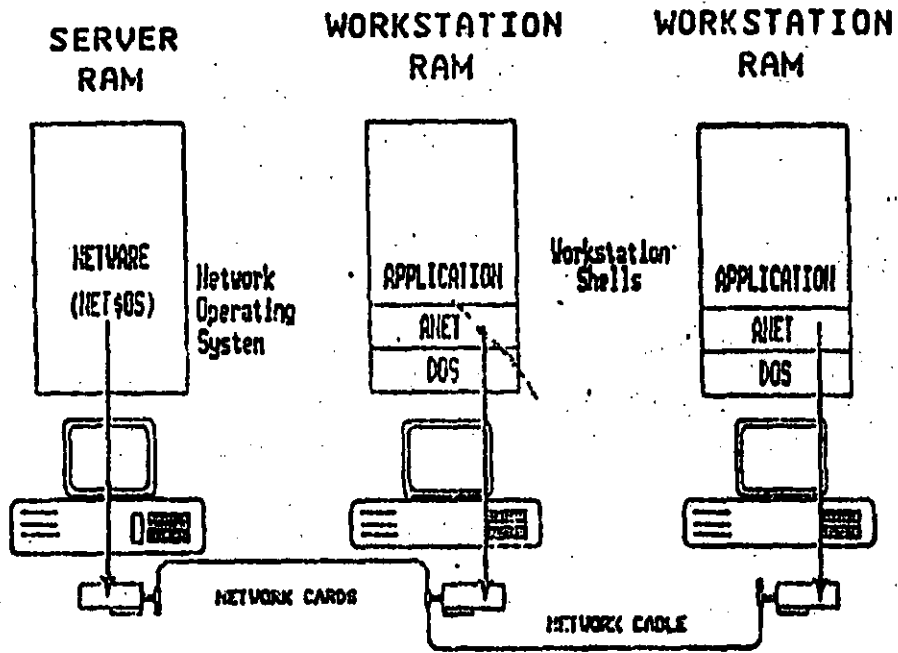

NetWare and the Shells Communicate with the LAN Hardware

Gateway Communications, Inc.

II

Fig. 7

## SHELL (Traductor De Comandos)

Para que las estaciones de trabajo puedan tener comunicación entre ellas, es necesario cargar un programa llamado Shell, que es el encargado de dirigir los llamados NETWARE hacia el File Server y los llamados de Dos hacia la estación de trabajo.

## CARACTERISTICAS PRINCIPALES DE NETWARE

I.- Aquí soporta todos los comandos de Dos lo cual es una ventaja, ya que los usuarios de las PC'S no tienen que aprender comandos nuevos.

Para ellos resulta totalmente transparente trabajar en RED.

II.- Contiene sus propios comandos, los cuales tendrán que ser manejados por un administrador o supervisor del sistema para optimizar y controlar la funcionalidad de la red.

Por medio de un Menu estos comandos pueden ser manejados con gran facilidad.

III.- Optimización del acceso a disco duro.

### a) Directory Caching:

Es el proceso de almacenar en memoria RAM las tablas de direcciones de los archivos (F.A.T.)

Por ello cuando existe una requisición de algún archivo, el servidor no lee estas tablas del disco duro, sino que lo hace en RAM para poder encontrar las direcciones de los archivos requeridos.

Mientras tanto las estaciones de trabajo de la Red pueden leer o escribir hasta 100 veces más rápido, de lo que sería si se leyeran las tablas F.A.T. directamente del disco duro.

### b) Directory Hashing:

Al indexar F.A.T. permite al servidor encontrar las direcciones correctas sin necesidad de examinar todos los datos de las tablas.

La ventaja que ofrece es una disminución del tiempo de acceso en un archivo hasta en un 30%, en comparación con las tablas F.A.T. no indexadas.

#### **c) File Caching:**

En este proceso se almacena en memoria RAM, los archivos que se usan con mayor frecuencia.

El servidor realiza una serie de estadísticas de los archivos que son solicitados con más frecuencia, mismos que son bajados a memoria RAM. Las subsecuentes peticiones de dicho archivo son atendidas hasta 100 veces más rápido que cuando éste no está en RAM.

#### **d) Elevator Seeking:**

Por medio de este proceso los requerimientos de entrada y salida de información del disco duro están ordenados de acuerdo con la posición física de las cabezas de dicho disco.

Esta característica nos ofrece una mayor velocidad de acceso y mayor duración de los discos duros.

### **IV.- Alta Seguridad:**

NETWARE permite al supervisor de la red configurar los niveles de seguridad, ya que estos pueden ser muy simples o sofisticados según se desee.

Dicha seguridad es proporcionada por NETWARE y está definida en cuatro niveles:

a) Claves De Acceso (Log - Password Security), se clasifica como primer nivel de seguridad, ya que sino se especifica el nombre de usuario y la clave de acceso asignados previamente por el supervisor del sistema, no se puede entrar a este .



b) **Derechos De Usuarios (Trustee Security)**, aquí se controla la habilidad individual de los usuarios para que éstos puedan trabajar con archivos en determinados directorios, para lo cual se cuenta con ocho Derechos de usuario que son los siguientes:

R - Leer archivos.

W - Escribir archivos.

O - Abrir archivos.

C - Crear archivos.

D - Borrar archivos.

P - Parental (crear, renombrar, borrar subdirectorios del directorio, asignar derechos a directorios y subdirectorios).

S - Buscar directorio.

M - Modificar atributos de archivo.

c) **Derechos De Directorio (Directory Security)**, este controla todos los derechos de usuarios que tienen asignados con excepción del supervisor en un directorio dado.

Quando se ha creado un directorio consta de los mismos derechos, los cuales son aplicados a los Derechos de Usuario (R, W, O, C, D, P, S, M).

Para proporcionar seguridad a un directorio el supervisor borrará los derechos necesarios, con el fin de prevenir un uso indebido de los archivos que contenga.

Un directorio está catalogado como el de mayor jerarquía, mientras que el de Usuario no se extiende a subdirectorios.

d) **Atributos De Archivos (Attribute file security)**, controla un archivo individual el cual puede ser compartido o modificado, ya que ayuda a proteger archivos de información pública leídos por numerosos usuarios.

A continuación se mencionan los atributos:

- \* Compartido - Shareable.
- \* No compartido - Non shareable.
- \* Sólo lectura - Read only.
- \* Lectura / escritura - Read write.

#### V.- Correo Electrónico:

En el NETWARE se incluye un paquete de correo electrónico sin costo adicional, mismo que permite enviar desde el mensaje más sencillo hasta el más complicado a cualquier usuario, gracias a un editor de textos integrado.

#### VI.- Comunicaciones Remotas y Gateway:

NETWARE nos permite tanto comunicaciones locales como remotas a través de los Gateway's, así podemos tener una red remota a través de un puente (bridge) o a un Mainframe por medio de un protocolo X - 25 o mediante un Gateway SNA a un Sistema IBM 43 XX etc.

Gateway es una función, la cual nos permite que varias PC'S instaladas en una red puedan tener comunicación con un host (mainframe-Mini), a través de una de ellas emulando terminales del host (fig. 8).

#### VII.- Independencia De Protocolo y Hardware:

Permite que conste de un sistema Heterógeno interoperable debido a la independencia de protocolo y Hardware, con este podemos tener un sistema tan complejo que cuente con PC'S IBM, Macintoshs, PS/2, compatibles y Host Mainframes y minis, Dos, OS/2 MAC, VMS, UNIX etc.

Con diferentes tipos de interfaces Ethernet, Arcnet, Token, Ring etc; ya que el NETWARE soporta más de 100 tarjetas de interfase en el mercado (fig. 9).

# Total Connectivity

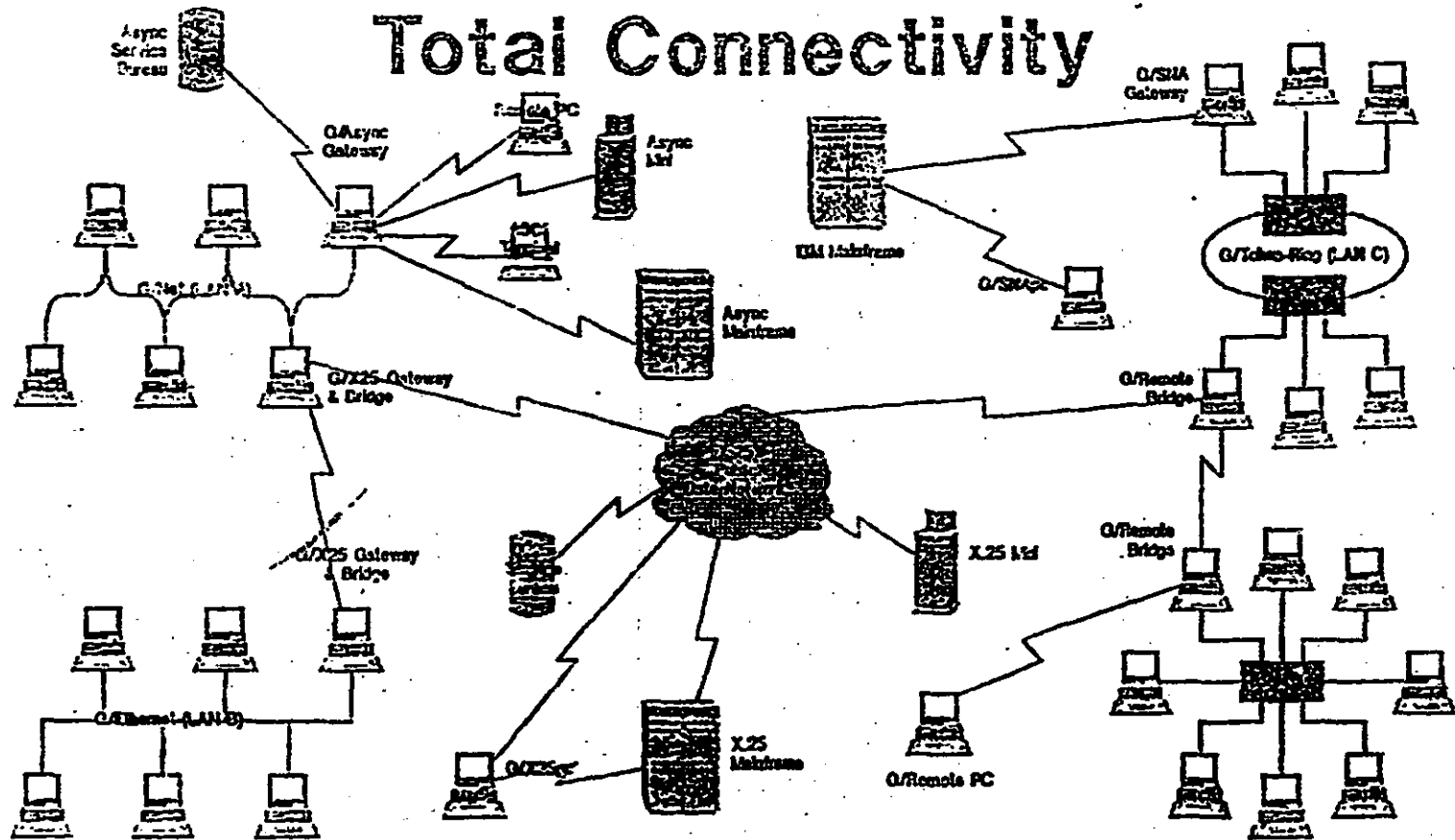

Fig. 8

# Estrategía de Novell

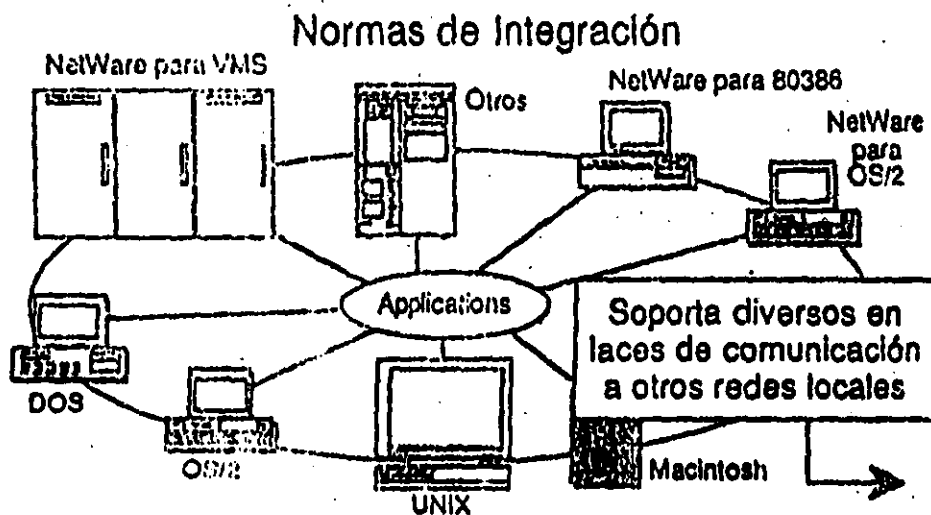

Fig. 9

## Tipos De NETWARE

### Advanced Netware 86 V2.0

- \* Este es un sistema operativo diseñado para trabajar con microcomputadoras contruidas con un microprocesador 8086 u 8088 compatibles con las IBM'S, PC, XT.
- \* Es capaz de soportar hasta 100 estaciones de trabajo.
- \* Contiene un almacenamiento en disco duro de 160 MB.
- \* Consta de cinco impresoras compartidas.
- \* Poporciona al file server una memoria de 640 KB.

### Advanced NETWARE 86 V.2 0A

- \* El sistema fue diseñado para trabajar con microcomputadoras construidas con microprocesador 80286 ya que en este serán aprovechadas las características, del direccionamiento de memoria virtual trabajando en el modo protegido.
- \* Esta capacitado para soportar 100 estaciones de trabajo.
- \* Trabaja con 15 000 MB de almacenamiento en un disco duro.
- \* Participa con tres impresoras compartidas.
- \* Cuenta con 16 MB de memoria RAM en el file server.
- \* En el procesamiento de tados ejecuta mayor velocidad.
- \* Existe una versión no - dedicada.

### Versión Dedicada

Una microcomputadora ubicada dentro de esta versión funcionará únicamente como servidor de archivos, ya que no le es posible tener funcion de estación de trabajo puesto que el sistema operativo no lo permite.

### Versión No Dedicada

Esta versión dentro de la microcomputadora funcionará como un servidor de archivos y estación de trabajo.

Aquí el usuario puede trabajar en la máquina procesando su propia información, mientras que se ejecutan las funciones de servidor de archivos.

Se debe de estar consiente de que cuando se usa el servidor de archivos en la forma no dedicada, existe la posibilidad de una degradación en la funcionalidad de la red puesto que una micro esta haciendo dos funciones lo cual alentará las operaciones.

### Entry Level Solution Nivel (SFT I, ELS I)

- \* Es un sistema operativo advanced NETWARE 286 V2.0A preconfigurado a cuatro usuarios.
- \* Sostiene cuatro estaciones de trabajo.
- \* Contienen las mismas características del AN 286 V2.0A.
- \* Se observan características adicionales.
- \* Proporciona protección de datos contra defectos en la superficie del disco.

### Hot Fix

Es una de las características del NETWARE del cual previene la escritura de datos sobre sectores dañados en el disco.

Cuando se activa el Hot Fix sobre el disco duro se crea una area de redirección (aproximadamente el 2% de la capacidad total del disco), en donde serán redirigidos los datos cuando se encuentra un sector dañado en el disco (fig. 10).

### Read After Write Verification

Cuando se ha escrito un dato sobre el disco duro inmediatamente se ejecuta una lectura la cual se dirige a la memoria para comparar la integridad del dato escrito; si la comparación despues de varios intentos no fuese satisfactoria el dato de esta es enviada por el hot fix a el área de redirección y se marca al sector dañado y enviado a la tabla de defectos del disco (fig. 10).

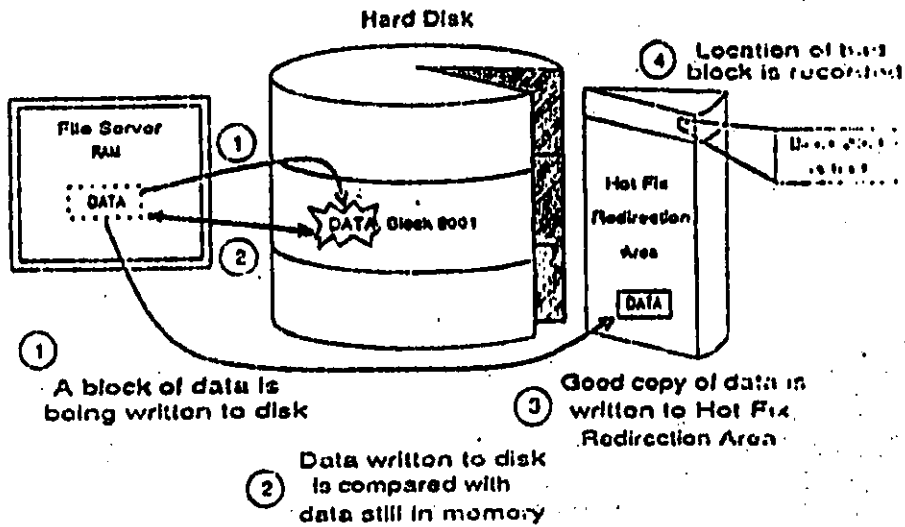

Read-After-Write Verification and Hot Fix

Fig. 10

### Advance NETWARE 286 V.21X (2.11, 2.12)

- Contiene las características del AN 286 V.2 0A.
- Monitoring UPS.
- Hot Fix.
- Read after write verification.
- Soporta 5 impresoras, 2 seriales y 3 paralelas.
- Maneja una memoria de 16 MB.
- Proporciona una capacidad de disco 2 GB.
- Admite cinco canales para discos hasta treinta y dos.
- Es un duplicado de DAT y FAT.
- Es capacitado para soportar 100 usuarios.
- Maneja una consola virtual (Fconsole).
- Value added process VAP'S.
- Accounting.
- Manejo de cola de impresión por menú (Pconsole).
- Versión dedicada y no - dedicada.

### Entry Level Solution II

- ELS I es el segundo nivel.
- El sistema Operativo AN 286 V2.12 es preconfigurado a ocho usuarios.
- Es diseñado para soportar ocho usuarios.
- Contiene las características de AN 2.12.
- Tiene un bajo costo.



### Advanced NETWARE 286 V1.15

- Cuenta con las características AN 286 V2.12.
- Proporciona el soporte de la interfase para estaciones de trabajo Macintosh.

### NETWARE SFT 286 V2.1 X(2.11, 2.12)

- Este sistema es tolerante a fallas de disco duro.
- Disk Mirroring.
- Disk Duplexing.
- TTS.
- Características del AN 286 V2.12.
- Dedicado.
- Es caro.

### NETWARE SFT 286 V2.15

- Contiene las características del SFT V2.12.
- Soporta la interfase para estaciones de trabajo Macintosh.

NETWARE para Macintosh

NETWARE para VMS

NETWARE Portable

UPS Monitoring - UPS (No-Break).- esta es una fuente de poder ininterrumpible la cual proporcionará al servidor de archivos y a una unidad de discos externos proporcionando energía la cual proviene de un sistema de baterías en caso de una interrupción en la alimentación de energía comercial.

El UPS monitoring es la función de control del Advanced NETWARE 286 este dará de baja el Servidor de archivos, si la alimentación de energía comercial no se restablece una cantidad de tiempo predeterminada.

VAP'S (Procesos de valor agregado). - aquí permite a los desarrolladores de software crear aplicaciones que puedan ser ejecutadas dentro del servidor de archivos, las versiones anteriores es el único proceso capaz de correr el servidor.

Accounting es una nueva característica del Advanced NETWARE 2.1 el cual nos permite lo siguiente:

- Hacer cargos por el uso de los recursos de la red los cuales pueden variar por hora o por día, puesto que el supervisor puede asignar el límite del crédito y hacer que el sistema monitor de usuarios haga un balance de cuenta y este saque del sistema a los usuarios que han sobrepasado su límite de crédito.
- Pone un límite de crédito a cada usuario.
- Monitorea el estado de cuenta de cada usuario.
- Genera una estadística del uso de un sistema.

Los cargos por uso del sistema pueden realizarse por:

- Tiempo de conexión al sistema.
- La cantidad de tiempo en el cual el usuario esta dentro del sistema.
- Los datos (programas/información) que el usuario requiere para que el servidor de archivos lea desde su disco.
- El usuario hace un determinado número de accesos hacia el file server.
- Una determinada cantidad de espacio en un disco usado.
- Cada 1/2 hora se harán los cargos.

### Incrementa La Seguridad Del Sistema

- \* Este restringe el horario de acceso al sistema a cada usuario.
- \* Acorta las estaciones del trabajo de acceso al sistema.
- \* Disminuye el número de conexiones concurrentes por usuario.
- \* El monitor de detección de intrusos al sistema bloqueando la estación de trabajo por medio del cual se pueda acceder al sistema.

### Fconsole

La utilería del sistema operativo crea una consola virtual la cual puede ser ejecutada por cualquier estación de trabajo en la red, esto permite un mayor control de los recursos de la red.

El Fconsole puede ser manejado por cualquier usuario ya que es posible acceder diferentes servidores de archivo, o ver información de LAN - DRIVES y la versión de un sistema operativo sobre el que se este trabajando.

Un supervisor que utilice el Fconsole podra en viar mensajes, revisar archivos, analizar información de conexión de los usuarios, alterna el status del servidor de archivos, observa las estadísticas del funcionamiento del servidor de archivos, se puede dar de baja el servidor de archivos y borrar la conexión de cualquier usuario.

### Fconsole

La utilería de este sistema operativo nos permite controlar la cola de impresión y con esto se puede efectuar lo siguiente:

- Crear, renombrar y borrar una cola de impresión.

### Spool

Este ejecuta un comando de impresión y cuando los datos que se requieran serán enviados a una cola de impresión en el disco duro, esto deberá ser realizado antes de dirigirse a la impresora; la cola de impresión mantiene los datos hasta que la impresora este lista.

### Disk Mirroring

La falla mecánica de un disco duro significa una pérdida total de datos almacenados sobre el disco, el SFT NETWARE nos proporciona una protección contra un mal funcionamiento del disco.

Esto es con el fin de obtener un duplicado sobre un segundo disco y esto recibirá el nombre de disco en espejo, el cual nos permitirá tener dos discos juntos en el mismo canal, puesto que los datos son escritos al disco primario y duplicados sobre el disco secundario en el cual siempre se tendrán respaldados los datos.

Si acaso alguno de los dos discos llegara a fallar aparecerá un mensaje de precaución en las estaciones de trabajo indicadas (fig. 11).

### Disk Duplexing

Los discos en espejo solo protegen datos contra fallas de discos duros y no contra fallas del controlador, SFT NETWARE tiene como característica que se le llama Disk Duplexing el cual nos permite tener un respaldo de datos en dos discos conectados a diferentes controladores (fig. 12).

### TTS. Transaction Tracking System

Esta característica previene una corrupción en bases de datos ya que si el sistema falla mientras se esta haciendo una transacción, aquí los datos no son escritos sobre la base de datos hasta que la transacción se termina, si una falla ocurre antes de la transacción termine los datos no serán escritos y permanecerán en su estado original con lo cual la información en la base de datos consistente (fig. 13).

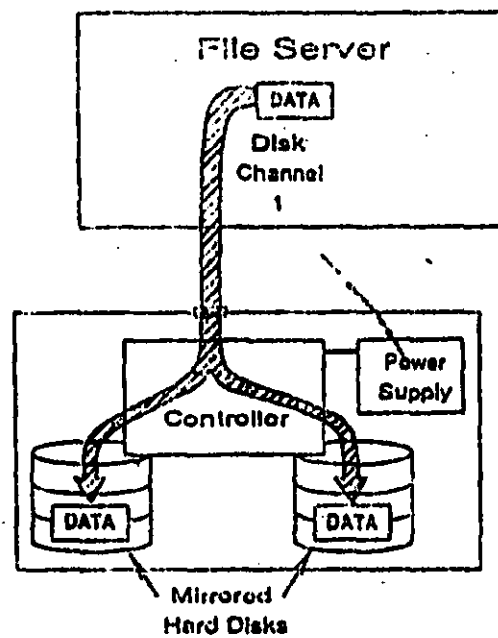

Disk Mirroring  
Fig. 11

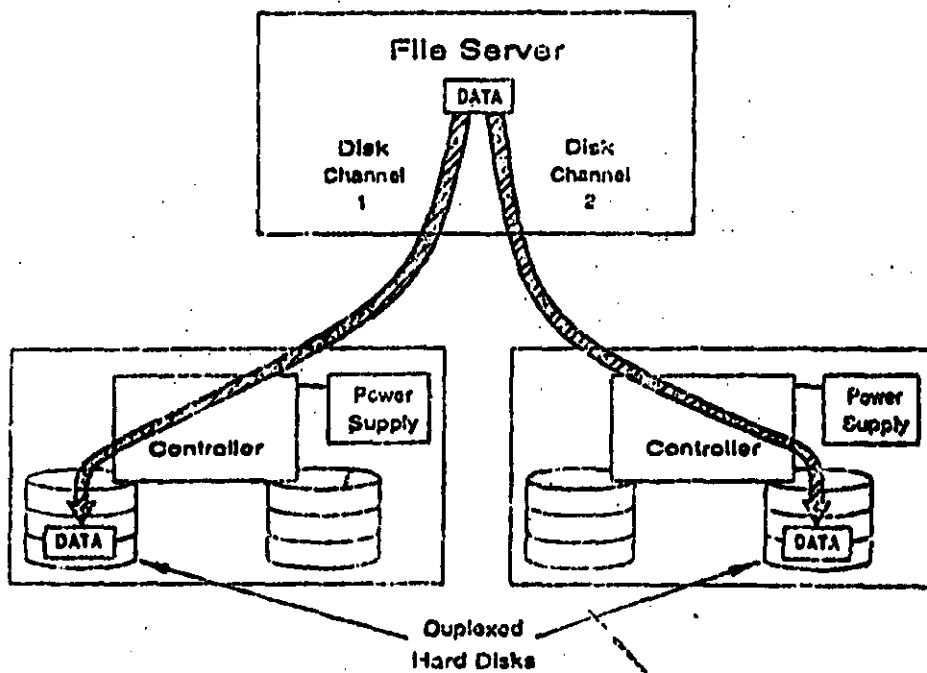

Fig. 12  
Disk Duplexing

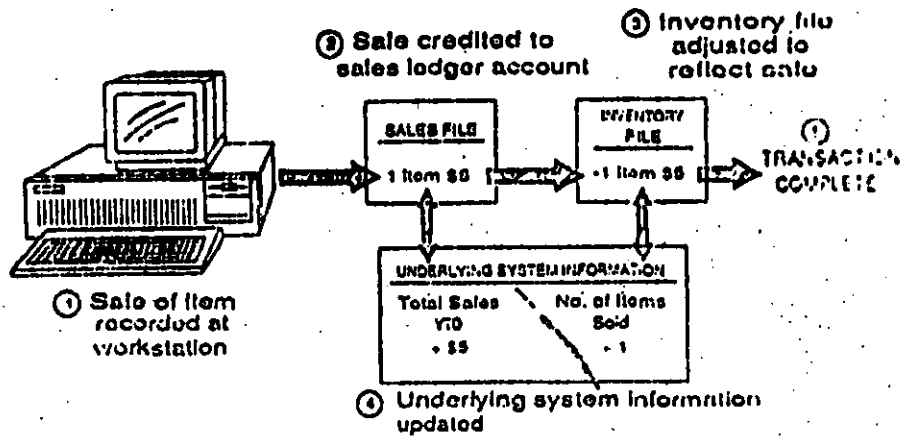

Fig. 13  
Sample TTS Transaction

### NETWARE PORTABLE

El NETWARE Portable es una versión del NETWARE tradicional diseñado para microcomputadoras y mainframes, estas son totalmente independientes del tipo de hardware y protocolos usados.

Gracias a ello los usuarios de PC y Macintosh instalados sobre una red local-NETWARE pueden compartir datos de servicios de impresión y aplicaciones con usuarios del host (Minis o mainframes).

Este producto nos ofrece una gran solución al integrar mainframes, minis, redes locales, PC, macintosh y otros tipos de instalaciones de trabajo.

El NETWARE para VMS es el punto de partida para dicho producto gracias a la gran aceptación que tuvo en el mercado debido a la transparencia de integración de red local host.

Uno de los primeros sistemas operativos del host destinado al desarrollo del NETWARE portable es Unix, el cual corre eventualmente bajo VMS, VM, MVS. Ya que es escrito en lenguaje C es implementado como una aplicación en el host (minis o mainframes), en la misma forma que NETWARE para VMS en una DEC VAX.

Se usará el Ethernet para propósitos ilustrativos o cualquier tipo de interfases para red soportada por NETWARE que puede ser usada, en el siguiente ejemplo se observa al NETWARE Portable como funciona en el host (fig. 14).

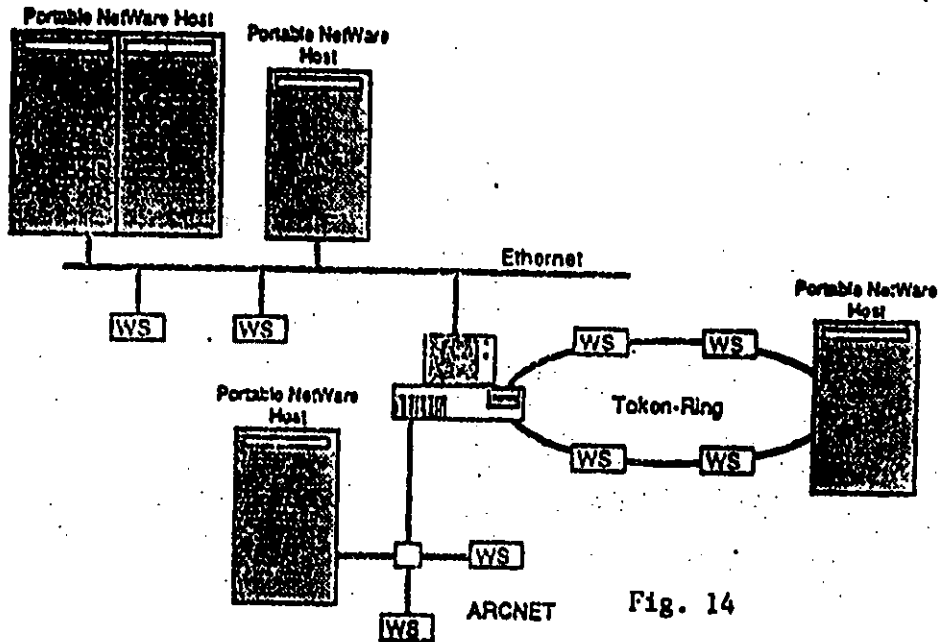

Fig. 14

ELS NetWare Level II is the second entry-level solution offered in Novell's NetWare product family. NetWare is the most popular operating system in the local area network (LAN) industry today. Like ELS NetWare Level I, ELS NetWare Level II is designed to save money and increase performance and productivity for small businesses, workgroups, and professional offices.

ELS NetWare Level II is an enhanced entry-level LAN solution that supports up to eight concurrent users. It incorporates key features and network management tools of Advanced NetWare v2.11—making ELS NetWare Level II the most powerful solution in the entry-level networking market.

The ELS NetWare Level II LAN has four parts: *workstations*, PCs where people work; the *file server*, an 8086, 8088, 80286, or 80386-based microcomputer that runs the NetWare operating system and centralizes the shared devices, programs and files; *cabling and network interface hardware*, computer equipment that fits inside a PC and connects workstations to form the network; and the *ELS NetWare Level II operating system* that coordinates the sharing of the file server's hard disk, printers, software and data.

ELS NetWare Level II gives users a choice of either an 86 dedicated or 286 nondedicated mode of operation. The 86 dedicated option means the 8086 file server can only be used as a file server. The 286 nondedicated mode allows the 80286 file server to be used concurrently as a workstation, adding a "free" workstation to the network. As your business grows and your network requires more than eight workstations, you can easily upgrade to one of Novell's larger operating systems, Advanced NetWare or System Fault Tolerant (SFT™) NetWare.

NetWare, setting the world's standard for local area networking, brings years of

solid research and reliability to the industry. If you are seeking an entry-level LAN solution, you can be assured ELS NetWare Level II addresses your needs more effectively than any other product in the market. Along with affordability, PC connectivity, and high performance, ELS NetWare Level II includes enhanced features for system security, fault tolerance, resource accounting, network administration and hardware independence.

### Features

Provides cost-effective business computing solutions in several ways:

- An ELS NetWare Level II LAN can be installed for thousands of dollars less than a mini or mainframe system, yet it offers comparable processing power for your small workgroup.
- Up to eight users (or logical connections) can share the files and application software stored on the file server's hard disks. Network users also share printers and other expensive peripherals.
- In addition to equipment and maintenance savings, employee training costs are minimal. If your employees know how to use a personal computer, they can use ELS NetWare Level II with little or no training.

Streamlines network performance.

- A multiuser, multitasking architecture enables ELS NetWare Level II to perform many operations simultaneously, resulting in faster network performance.

# ELS NetWare Level II

LEVEL II

ENTRY-  
LEVEL  
SOLUTION  
NETWARE  
LEVEL II v2.12





- Database applications, the most-used business software, actually perform better when executed on a LAN than on a standalone PC. This means faster response times and faster disk access.

- Indexed File Allocation Tables (turbo FATs) allow file allocation tables on large files (more than 2MB) to be searched quickly, thus improving the speed of disk reads.

Restricts access to sensitive data with enhanced network security.

- Expiration dates and resource usage limits can be assigned to user accounts.

- LOGIN times, physical stations, and number of attempts can be limited for each user account.

- Half-hour security checks determine whether a user can log in (or is permitted to be logged in) during that time period, whether a user's account has expired or been disabled, and whether a user's account has run out of funds.

- Unauthorized or overdrawn user accounts are automatically logged off every half hour (following a five-minute warning).

Protects network data automatically with basic system fault tolerance.

- In addition to duplicate directories, the Hot Fix feature included in ELS NetWare Level II provides disk media defect detection and correction while the system is running. When a bad block is detected during a write operation, the data is moved to a safe area of the disk and the bad block is marked as unusable.

Keeps track of network resource use with system accounting features.

- ELS NetWare Level II allows your business to charge for network resource use. Users can be charged for connection time, for bytes read or written to disk, for use of storage space on disks, or for the number of requests

made by a workstation. Rates can vary by the hour and by the day. Supervisors can assign credit limits and have the system monitor users' account balances and log them off if they overextend their credit limits.

Contains new tools for third-party developers.

- Value-Added Processes (VAPs) will run in the 286 mode of the operating system. VAPs allow independent software developers to create server-based applications for NetWare networks.

- Other new application program interfaces include: Btrieve VAP, resource accounting, queue management, network diagnostics, virtual console and security.

Simplifies network management tasks with easy-to-use menu-driven utilities.

Allows system supervisors to limit the amount of disk storage available to a user and includes the new supervisory utility named USERDEF for ease in setting up users on the system.

Includes asynchronous remote bridge software (COM1/COM2) for long-distance communications.

Runs off-the-shelf on most network hardware and includes a NetBIOS emulator for IBM-compatible hardware.

Supports IBM Personal System/2 computers as file servers or workstations, as well as IBM PC AT, PC XT and PC compatibles.

Operates on all popular topologies, including Ethernet, ARCNET®, Token-Ring® and other familiar network adapters.

Runs popular applications invisibly. ELS NetWare Level II is compatible with DOS 2.x, 3.x, 4.x, Windows/386, OS/2 Standard Edition 1.x and OS/2 Extended Edition 1.x.

## Technical Specifications

ELS NetWare Level II v2.12 is an enhanced entry-level solution designed for small businesses, workgroups and professional offices. It supports up to eight active users on the network; however, more than eight can have network accounts. The operating system does not require a keycard.

## Hardware Requirements

### Dedicated Operating System:

File Servers: IBM PC XT or close compatibles; IBM PS/2 Model 30  
File Server Memory: 640KB

### Nondedicated Operating System:

PC AT-Bus File Servers:

IBM PC AT

IBM XT/286

Compaq 286 (older models may require ROM upgrade and keyboard controller change)

Compaq 386

NCR Model 8 (with firmware revision 4.42)

Novell NetWare 286A File Server (requires BIOS Rev. 2.61 and RT101 keyboard)

Novell NetWare 386A File Server (requires most current version of BIOS and motherboard)

Hewlett Packard Vectra ES/12

Hewlett Packard Vectra RS/20

Epson Equity II+

Epson Equity III+

NEC APC IV PowerMate 1 (requires Phoenix BIOS 3.07.02)

NEC APC IV PowerMate 2 (requires Phoenix BIOS 3.07.02)

Acer 910 (requires KB101A keyboard)

Acer 1100 (requires KB101A keyboard)

Zenith Z300

Wyse WY2112

Wyse WY3216

Mitsubishi MP286 (must use enhanced keyboard)

Mitsubishi MP386 (must use enhanced keyboard)

Hyundai SUPER-286

Hyundai SUPER-286C

Micro Channel-Bus File Servers:

IBM PS/2 Model 50, 60, 70 or 80

File Server Memory: 1MB minimum extended memory with 640KB base memory for nondedicated use.

ELS NetWare Level II supports the following disk controllers:

### Dedicated Operating System:

IBM AT Western Digital internal controller

IBM XT controller

IBM PS/2 Model 30 controller

### Nondedicated Operating System:

IBM AT Western Digital internal controller

IBM PS/2 MFM controller (model 50, 60)

IBM PS/2 ESDI controller (model 60, 70, 80)

ELS NetWare Level II supports the following workstations:

### PC AT-Bus Workstations:

IBM PC

IBM PC XT

IBM PC AT

IBM PS/2 Models 25 or 30

True IBM compatibles

### Micro Channel-Bus Workstations:

IBM PS/2 Models 50, 60, 70 or 80

### Workstation Memory:

Shell and driver: 55-65KB

Shell and DOS applications: 384KB

All applications: 512KB

ELS NetWare Level II includes the following core set of LAN drivers:

Novell NE-1000 Ethernet

Novell RX-Net

IBM Token-Ring (includes Micro Channel board support)

IBM PCN II Primary (includes Micro Channel board support)

IBM PCN II Alternate (includes Micro Channel board support)

Micom-Interlan NP600 Ethernet

Micom-Interlan NI-5010 Ethernet

Standard Microsystems ARCNET/Pure Data

Standard Microsystems ARCNET-PS110 (Micro Channel)

Gateway Communication G/NET

Proteon ProNET with Checksum

3Com Etherlink 3C501

3Com Etherlink II 3C503

3Com Etherlink Plus 3C505 (Assembly 2012)

3Com Etherlink Plus 3C505 (Assembly 1194)

3Com Etherlink/MC 3C523

Other drivers may be ordered separately.

## For More Information

Call Novell NetWare Products Division, 1-801-379-5900.

NetWare is a registered trademark of Novell, Inc. IBM is a registered trademark of International Business Machines Corporation. Other computer software names identified by ® or ™ are registered trademarks of their respective manufacturers.

# ELS NetWare

## LEVEL II

ENTRY  
LEVEL  
SOLUTION  
NETWARE  
LEVEL II v2.12

**N**etWare is known as the LAN operating system that lets you choose. Choose the software that does your kind of work. And choose the hardware that gets the work done. NetWare's "freedom to choose" philosophy has made networking less expensive and more versatile for hundreds of thousands of NetWare users.

#### **Your choice.**

You've heard of OS/2 — IBM's second-generation operating system for microcomputers. Many are calling OS/2 revolutionary. Many applications developers are already using the advantages of OS/2 to design faster, more powerful applications. Integrating these advancements into your existing network makes good business sense.

It makes enough sense that it prompted IBM and Novell to get together to share some ideas.

So, what do you get when you combine the networking expertise of NetWare engineers with the assistance and the blessing of IBM? You get a highly functional, yet friendly, workstation operating system that runs on the industry's most touted local area network operating system.

Does it run? You ought to see it run — on a NetWare LAN.

The key to the NetWare — OS/2 connection is a software module called the NetWare Requester for OS/2.

#### *What is a Requester?*

The NetWare Requester is similar to the NetWare shell that DOS workstations use to access a NetWare network. A closer look at both will help clarify their differences.

#### *The NetWare Shell.*

The NetWare shell, used by DOS workstations connected to NetWare networks, sits on top of the DOS operating system (see figure 1). As a user works with an application, be it word processing, database or spreadsheet, he/she types commands into his/her computer

## NetWare Requester for OS/2™

**NetWare.  
gives you  
the freedom  
to choose.**

**Again.**

and expects a response. The NetWare shell intercepts these commands and determines if they are meant to be passed to DOS or directed to the file server where the NetWare operating system resides. The NetWare shell makes it possible for the user to type commands on his/her keyboard without worrying if the commands are DOS or NetWare. The shell takes care of directing commands to their proper destination.

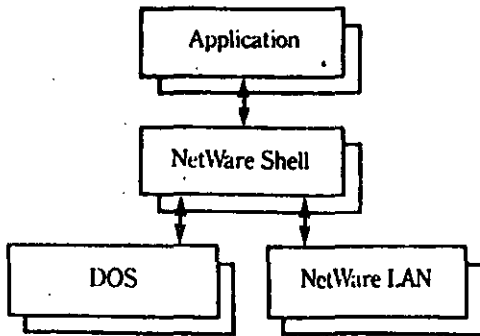

Fig. 1: NetWare Shell Model

*The NetWare Requester.*

The NetWare Requester takes a slightly different approach to directing requests. Where the NetWare shell sits on top of the workstation operating system, the NetWare Requester lies under the OS/2 operating system (see figure 2). Requests made by a user from an application are first sent to the workstation operating system, OS/2. OS/2, in turn, determines if the command is for itself or the network. If it is a network command, OS/2 passes it off to the requester. The requester sends the command to the NetWare operating system. Again, the user does not have to be concerned with whether

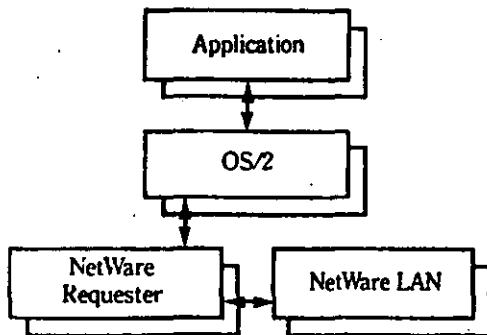

Fig. 2: NetWare Requester Model

the call is for the workstation or the network. These decisions, in the case of the NetWare Requester, are made by OS/2.

**Choose performance.**

OS/2's building-block design encourages developers to enhance the operating system. By taking advantage of this invitation to enhance, NetWare engineers designed a system that combines the best of OS/2's general-purpose functions with NetWare's specialized networking functions. The end result is an OS/2 network that utilizes state-of-the-art technology from various vendors en route to the superior LAN solution.

**Choose your operating system.**

Supporting OS/2 and only OS/2 doesn't do much for freedom of choice. Following NetWare goals for Open Protocol Technology (OPT), OS/2 workstations on NetWare LANs can run alongside workstations running DOS or Windows/386 (see figure 3). OPT allows for the integration of protocols so that different kinds of workstations can communicate with a common file server. This means OS/2 can also run alongside any future workstation operating system that falls under the OPT umbrella. To this end, NetWare makes growth inexpensive, easy and painless.

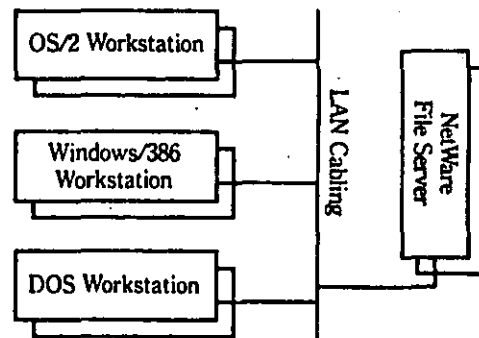

Fig. 3: Workstation Operating System Model

**Choose server-based applications.**

The telephone company's directory assistance service provides an excellent way to find telephone numbers that you don't have at your fingertips. Imagine, however, if the directory assistance program consisted of nothing but a

stockpile of directories in a central location. If you needed a number, you could drive to the stockpile, check out one of the directories, and look for the number in question. If you couldn't find the number in the directory you checked out, you could go back and check out a new one. The cycle would continue until the correct number was located in the proper directory.

Redundant as it seems, this scenario is similar to how disk-intensive applications (running at workstations) access data from a file server. To get information from a file server, many database applications running at a workstation must send requests to the server for a block of data. If the needed information isn't found in the block that was requested, the cycle is repeated again and again until the sought-after data is found. This process adds traffic to the network and consequently slows down the file server's response to other requests.

Thus the incentive for server-based applications.

Server-based applications work like directory assistance operators. The operators have a database of directories at their fingertips. Likewise, the server-based application draws from disk drives in (or connected directly to) the file server.

The directory assistance operator accepts simple requests from callers, processes the requests, retrieves the proper numbers and returns each to the appropriate caller. The server-based application receives simple requests from its workstation-based counterparts, processes the requests, accesses the proper data and quickly returns its response to the appropriate workstations.

The directory assistance operator is specially trained and is given tools designed to efficiently locate correct telephone numbers. The server-based application is specially designed to receive requests from workstations, process the requests by locating the proper information, and return the requested data. In both cases, the retrieval of data is expedited and traffic (be it highway or network) is reduced.

## Choose your options.

NetWare provides a host of options for the OS/2 server-based application. Users running OS/2 are given the freedom to choose the option which best serves their configuration, performance and price needs.

### *Server-based applications running externally.*

OS/2 server-based applications can run in workstations that are external to the NetWare file server. These server-based applications can run in workstations that share processing power with OS/2 and other applications (non-dedicated option) or in workstations that are used solely for the server-based application (dedicated option).

The dedicated workstation, when teamed with an OS/2 server-based application designed for high-performance processing, is called an application server.

### *Server-based applications running at the file server.*

The NetWare Applications Coprocessor opens the door to OS/2 server-based applications that run in NetWare file servers. The coprocessor is a board that houses an 80286 microprocessor and the necessary memory to run the server-based application. With this configuration, NetWare runs in the file server's processor and the server-based application runs in the application coprocessor board's processor.

### *Nondedicated NetWare for OS/2*

Another option is to run all three applications, OS/2, NetWare and the server-based application in a single processor. A special version of NetWare has been designed that will run as a task or extension of OS/2. This is the most cost-effective alternative of the three. NetWare engineers have gone to great lengths to ensure that NetWare running as a task of OS/2 remains efficient by using NetWare's network-optimized file system. As with any application that shares processing power and memory, this option may run slower than either the external or the applications coprocessor options.

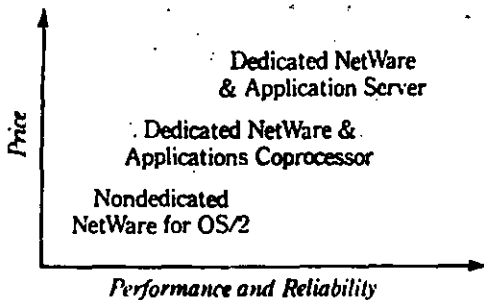

Fig. 4: NetWare Migration Model

As figure 4 illustrates, NetWare for OS/2 allows you to pick the solution that best fits your cost and performance objectives. For example, Nondedicated NetWare for OS/2 is designed as an inexpensive solution for smaller networks. While the dedicated NetWare and application server option is a high-performance solution. As your needs grow, you can follow this no-hassle migration path offered only by NetWare.

#### Choose your protocol.

In order for any of the server-based applications to operate, a means must be established for the workstation portion of the application to communicate with the server-based portion. IBM is encouraging developers to use its NetBIOS and LU6.2 protocols. Microsoft has developed two new transport mechanisms for OS/2 called Named Pipes and Mail Slots. In keeping with its strategy of Open Protocol Technology, the NetWare Requester for OS/2 will support all of the above. This allows NetWare, through protocol independence, to support all OS/2 server-based applications.

#### Choose the winner.

NetWare is a proven performer. It is built on a stable foundation of networking features that evolved through eight generations of development. NetWare's reliability is unmatched. Its features are comparable to those found in mini-computers and mainframes — at a fraction of the cost.

Fault tolerant features protect your data from loss due to hardware failure and power inconsistencies. NetWare gives you the highest level of LAN data protection available — anywhere.

NetWare security features are the industry's most complete. New intruder lockout features protect your data from unauthorized access.

File servers use NetWare's resource accounting features to keep accurate records of LAN use (computer time, disk space, etc.).

Network management features simplify the tasks of managing a network. System supervisors use NetWare management tools to troubleshoot from any workstation on a NetWare LAN.

Choosing to go with NetWare is a choice to run with the winner. Choosing NetWare means freedom to use whatever hardware, software and workstation operating system works best for you. Choosing NetWare is also a vote for stability. NetWare has offered the freedom to choose since its inception. And all indications point to a long and successful future — based on freedoms that allow you choices of efficient, cost-effective and functional solutions that work for you.

World Headquarters  
122 East 1700 South  
Provo, Utah 84601  
(801) 379-5900

NetWare is a registered trademark of Novell, Inc.

IBM is a registered trademark of International Business Machines Corp.

OS/2 is a trademark of International Business Machines Corp.

Other computer software names identified by  
® or ™ are registered trademarks of their respective manufacturers.

© 1988, NOVELL, INC.

735-000280-001

NOVELL

**N**etWare for VMS is a software product that allows any VAX®/VMS computer to function as a network file and print server for IBM and IBM-compatible PCs. NetWare for VMS is based on Novell's Advanced NetWare, the industry's most popular operating system for PC local area networks (LANs). NetWare for VMS affirms Novell's commitment to open systems design and architecture. As part of Novell's UNA (Universal NetWare Architecture) strategy, NetWare for VMS combines the power of VAX/VMS and NetWare LAN services into one product.

Operating as a single process within the VAX, NetWare for VMS extends the LAN environment to allow PCs shared access to data, print services and applications located on the VMS host. With NetWare for VMS, PC users can access information and resources on mini-computers with familiar PC commands and programs.

NetWare for VMS brings the power of VAX/VMS to each PC user by offering seamless file access and file sharing with the VAX. NetWare for VMS provides transparent connectivity; in other words, files located on the VAX server appear as DOS files to the PC user, while to the VAX user they are standard VMS files.

For the VAX, NetWare for VMS eliminates the need for non-DEC® hardware. It is a software connectivity solution that uses standard DEC VAX Ethernet adapters. For the PC LAN, NetWare offers hardware independence by supporting more than 85 network adapters. Users on networks such as Token-Ring, STARLAN™, ARCNET® and others can access the VAX on Ethernet from their normal PC LAN environment, as they would any other NetWare file server.

NetWare for VMS supports popular terminal emulation packages through its Terminal Emulation Service (TES). TES allows PC users to log in to the VAX and run standard VAX/VMS applications. Terminal emulation for VT100, VT220, VT240, Tektronix™ 40xx and other terminals is supported by NetWare for VMS through third-party software.

# NetWare for VMS. v2.0a

---

NetWare® gives you  
the freedom  
to choose.

# Features

## Transparent file services:

### Information sharing between PC and VAX.

The VAX appears as a standard Advanced NetWare server to the PC user. NetWare utilities, DOS commands and applications can access VAX files as if they were standard DOS files.

## Transparent print services:

### Resource sharing between PC and VAX.

VAX printers are available to the PC user as if they were attached directly to the PC. NetWare for VMS sends PC print requests to the VAX/VMS print spooler and queue manager so PC users can print on VAX printers. Management of the print queue is handled through VMS print facilities.

## System management:

### Security control.

NetWare for VMS uses all the system management and security provisions (User Authorization File) within the VAX/VMS environment. NetWare's complete set of security and file services, combined with full VAX/VMS security, means greater protection and data integrity for the NetWare for VMS user.

## Virtual file:

### Access from both environments.

Each NetWare for VMS file is stored as a standard VMS file so file space can be allocated dynamically. DOS files can be accessed by VMS users and processes. This enables standard VAX backup and archive procedures to be used to back up NetWare for VMS data.

## Server-to-server communications:

### Remote access.

NetWare for VMS uses DECnet® facilities to access a remote VAX/VMS running NetWare for VMS. NetWare for VMS allows each remote VAX to be viewed as a NetWare file and print server, regardless of its location.

## NetWare for VMS Remote Support

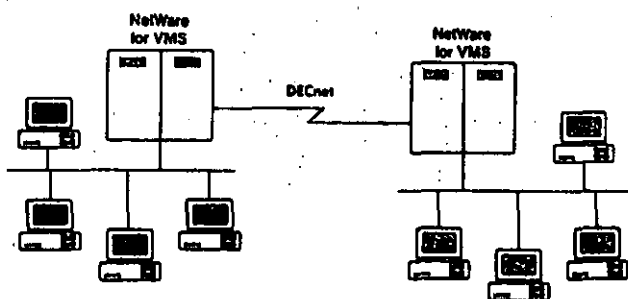

## Terminal Emulation Service (TES):

### VAX integration.

TES allows PC users to log on the VAX over the network and run VMS applications. This extends greater speed and flexibility to the PC LAN user by offering terminal emulation support from several terminal emulation vendors.

## Compatibility:

### VMS and PC servers on the same network.

NetWare for VMS runs on all DEC VAX/VMS systems, from MicroVAXII to VAX 89xx hosts. It supports standard NetWare client software, enabling users to access 286- and 386-based NetWare servers and NetWare for VMS servers concurrently.

## High performance:

### High reliability.

Combined with the power of VAX/VMS, NetWare for VMS maintains NetWare's goal of providing the highest LAN performance in the industry. Along with performance, NetWare provides integrity and reliability to the LAN.



# Statement of Direction

## Hardware independence:

### Support for multiple network topologies.

NetWare for VMS uses DEC VAX Ethernet controllers (DEUNA, DELUA, DEQNA, DELQA, DESVA, DEBNT). It requires no non-DEC hardware in the VAX. Using NetWare bridges, NetWare for VMS supports more than 30 LAN topologies in the PC environment. Advanced NetWare supports more than 85 network adapters. Multiple network topologies supported by NetWare can be internetworked to provide greater access to NetWare for VMS.

## NetWare for VMS Network Support

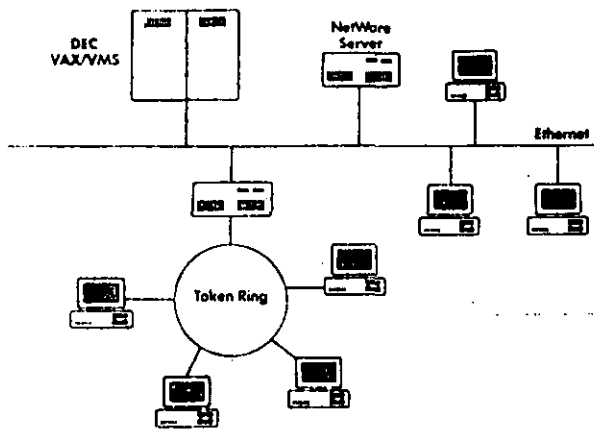

## VAX utilization:

### Low overhead.

Because NetWare for VMS runs as a single VMS process, it minimizes VAX system overhead.

Other VMS applications can run concurrently with NetWare for VMS, thus expanding the services of the VAX/VMS environment.

## Workstation support:

### PCs and PS/2s.

A large variety of IBM PCs, XTs, ATs, PS/2s and compatibles can be used as NetWare workstations. Workstation operating systems supported by NetWare are DOS 2.x and 3.x; Windows/386™ and OS/2™ Standard Edition 1.0. Any combination of these workstation operating systems runs on the network and can gain access to the NetWare for VMS server.

Novell is committed to maintaining full compatibility between NetWare 286 and NetWare for VMS operating systems. Novell also plans to maintain the cooperative processing environment for server-based applications running between PC workstations (both DOS and OS/2) and VMS.

NetWare for VMS provides a basis for cooperative processing between PCs and VAX systems. It promotes development of distributed-processing applications that combine the local processing and friendly interface of desktop computers with the performance and capacity of VAX systems. Comprehensive interprocess communications and remote-procedure call facilities in NetWare for VMS make it easy to develop and operate network applications.

Because NetWare for VMS is fully compatible with OPT (Open Protocol Technology), workstation support for NetWare for VMS to Macintosh® and UNIX® workstations is part of the product's strategic plan. Novell's commitment to seamless connectivity between unlike environments promises a secure future for NetWare for VMS.

# Features

## Transparent file services:

### Information sharing between PC and VAX.

The VAX appears as a standard Advanced NetWare server to the PC user. NetWare utilities, DOS commands and applications can access VAX files as if they were standard DOS files.

## Transparent print services:

### Resource sharing between PC and VAX.

VAX printers are available to the PC user as if they were attached directly to the PC. NetWare for VMS sends PC print requests to the VAX/VMS print spooler and queue manager so PC users can print on VAX printers. Management of the print queue is handled through VMS print facilities.

## System management:

### Security control.

NetWare for VMS uses all the system management and security provisions (User Authorization File) within the VAX/VMS environment. NetWare's complete set of security and file services, combined with full VAX/VMS security, means greater protection and data integrity for the NetWare for VMS user.

## Virtual file:

### Access from both environments.

Each NetWare for VMS file is stored as a standard VMS file so file space can be allocated dynamically. DOS files can be accessed by VMS users and processes. This enables standard VAX backup and archive procedures to be used to back up NetWare for VMS data.

## Server-to-server communications:

### Remote access.

NetWare for VMS uses DECnet<sup>®</sup> facilities to access a remote VAX/VMS running NetWare for VMS. NetWare for VMS allows each remote VAX to be viewed as a NetWare file and print server, regardless of its location.

## NetWare for VMS Remote Support

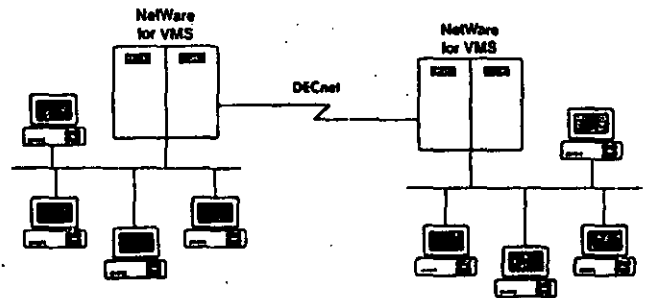

## Terminal Emulation Service (TES):

### VAX integration.

TES allows PC users to log on the VAX over the network and run VMS applications. This extends greater speed and flexibility to the PC LAN user by offering terminal emulation support from several terminal emulation vendors.

## Compatibility:

### VMS and PC servers on the same network.

NetWare for VMS runs on all DEC VAX/VMS systems, from MicroVAXII to VAX 89xx hosts. It supports standard NetWare client software, enabling users to access 286- and 386-based NetWare servers and NetWare for VMS servers concurrently.

## High performance:

### High reliability.

Combined with the power of VAX/VMS, NetWare for VMS maintains NetWare's goal of providing the highest LAN performance in the industry. Along with performance, NetWare provides integrity and reliability to the LAN.

---

## Portable NetWare at the Host

The following overview shows how Portable NetWare functions on a host. Ethernet is used in this example for illustrative purposes, but any type of supported LAN is possible. The specific configuration options depend upon each particular host implementation of Portable NetWare. Vendors will supply their own device drivers for the desired configurations.

### Processing at the Workstation

Portable NetWare supports standard NetWare v2.1x workstations. In fact, there is no difference in how a workstation communicates with a host-based or a micro-based version of NetWare.

DOS and OS/2 workstations use NetWare's network transport facilities (IPX/SPX) to send NetWare Core Protocol (NCP) requests directly to the file server. NCPs are service calls that can be made by NetWare clients to be performed at the file server. For DOS and OS/2 workstations, these NCP requests are generated directly at the workstation. NetWare's Open Protocol Technology (OPT) allows other types of workstations, such as the Macintosh, to make service requests using their native network transport and service protocols. For example, the Macintosh uses the AppleTalk transport and AppleTalk Filing Protocols (AFP) to communicate with NetWare. AFPs are then converted to NCP requests for servicing by NetWare file servers. The Macintosh VAPs that actually do this conversion may reside in either a micro-based NetWare server or in an external bridge. In the first release of Portable NetWare the Macintosh VAPs must reside in a NetWare external bridge, or on a NetWare v2.15 server on the network, in order to facilitate Macintosh connectivity to the Portable NetWare host. In the future, Macintosh support, as well as support for other client-server protocols such as NFS and SMB, will be provided within the Portable NetWare host.

Once the NCP request is formulated at the workstation or in the Macintosh VAP, it is handed off to the network transport facility (IPX), encapsulated in an Ethernet packet and placed on the wire for transmission to the server.

## Processing at the Portable NetWare Host

The host's Ethernet hardware picks up the Ethernet packets from the wire and delivers the packets to the Ethernet device driver (see Fig.1). The Ethernet device driver then processes the Ethernet packet and passes all NetWare related packets to the IPX/SPX Driver for further processing. The file server makes no distinction between service calls made by DOS, OS/2 or Macintosh workstations.

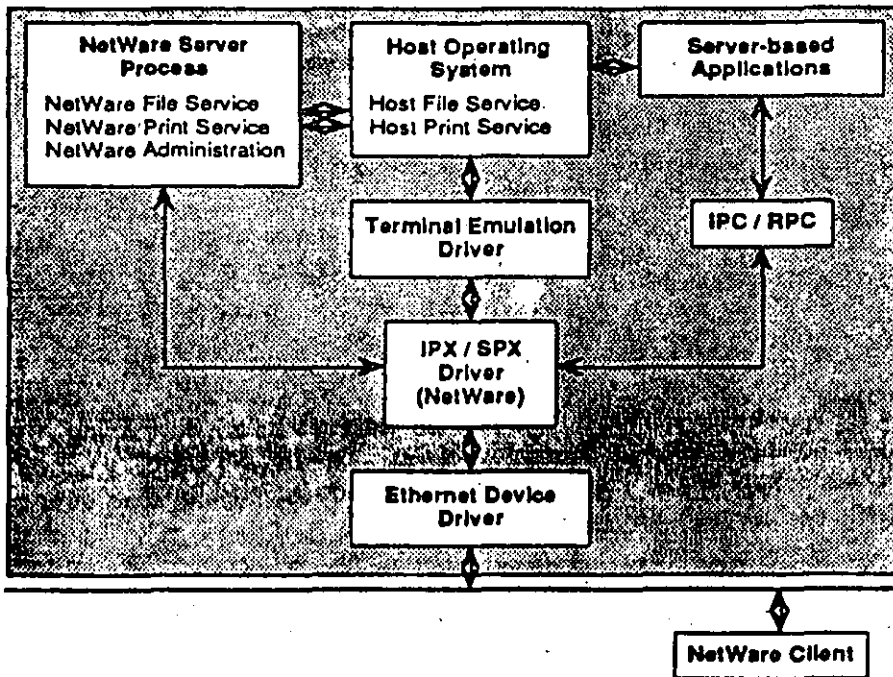

Fig. 1: Portable NetWare Architecture.

The IPX/SPX Driver further processes the arriving packets and routes the data to either the *Terminal Emulation Driver* for terminal I/O, the *IPC/RPC Interface* for server-based application processing, or to the *NetWare Server* for all other types of processing including file, printer and routing requests.

## The Terminal Emulation Driver

Terminal emulation gives workstation users connectivity to the host environment just as if their workstations were wired directly to the host's terminal ports. Portable NetWare's terminal emulation driver interacts with the IPX/SPX driver to send and receive data from NetWare workstations. The terminal emulation driver processes the given protocols and routes the characters either to the host via the host terminal driver, or to the workstation via the IPX/SPX driver.

Traditionally in host systems, intelligent workstations using terminal emulation are connected asynchronously to the host. With Portable NetWare, workstations using terminal emulation are connected via Ethernet (for example), greatly increasing the performance of terminal emulation as well as simplifying the installation of new terminal lines.

Portable NetWare supports a variety of third-party terminal emulation programs, such as Reflections, Smarterm and Polystar.

## The IPC/RPC Driver

IPC/RPC hooks are available to software developers who are developing server-based applications for Portable NetWare. The IPC/RPC facility allows developers to exploit existing host applications and resources by distributing the front-end processing to the client workstations.

The Inter-Process Communication (IPC) facility allows communication between processes residing on the host and Portable NetWare clients. The IPC is a Streams-based communication facility written on top of Portable NetWare's IPX/SPX driver at the host and matched with an IPC facility at the workstation. This service allows workstations to communicate with host server-based applications, such as database transaction, X.400 MIA Communication Gateway. (See Fig. 2.)

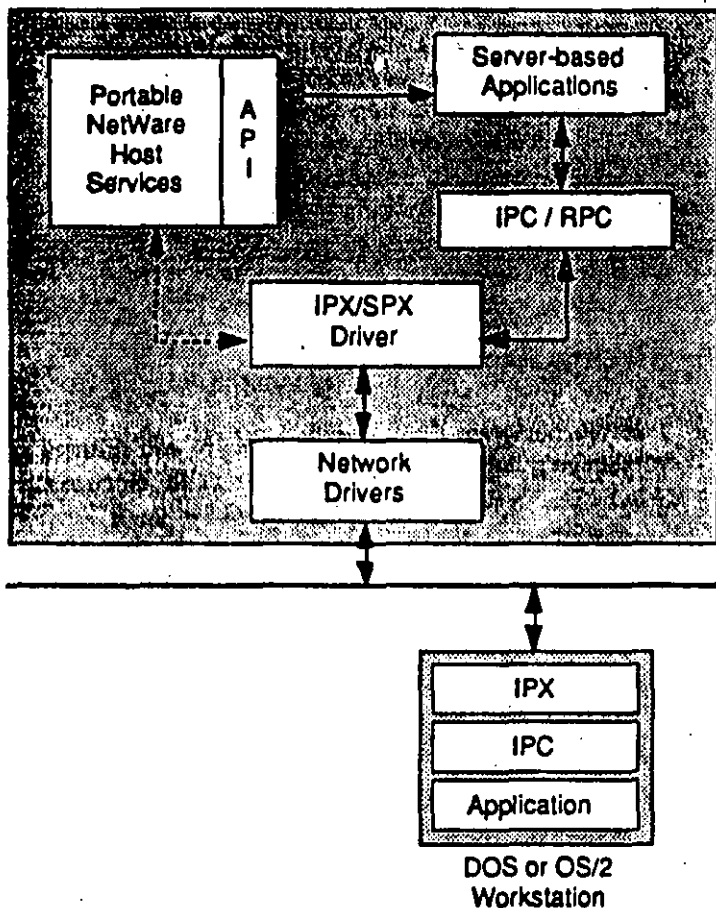

Fig. 2: Portable NetWare support for server-based applications.

Portable NetWare supports Remote Procedure Calls (RPC) and is compatible with Novell's NetWare RPC product, available from Novell's Development Products Division. NetWare RPC is a set of programming tools designed to help the software developer create distributed network applications. The product automatically generates code to manage network interprocess communications and to translate data into machine-independent ASN.1-compatible format. NetWare RPC can also help the software developer redesign or develop applications that distribute processor-intensive tasks to more powerful or idle CPUs on the LAN.

### **The Portable NetWare Server**

The Portable NetWare server performs file and print services and returns data to the IPX/SPX driver for transmission to workstations over the network. The Portable NetWare server also performs all NCP processing, all administrative commands, and controls the IPX/SPX driver. All the standard features of traditional PC-based NetWare servers are included in the Portable NetWare server.

NetWare for Macintosh brings the comprehensive features of NetWare local area networks to the user-friendly Apple Macintosh environment. Macintoshes and PCs can now interoperate on NetWare LANs.

Featuring 100 percent AppleTalk compatibility, the product transforms economical IBM-compatible PCs into high-performance AppleShare™ network servers. NetWare for Macintosh allows file, message and printer sharing with other Macintoshes and with PCs.

NetWare for Macintosh is a software package that gives Macintosh workstations full access to the services of NetWare v2.15 network servers (SFT, Advanced or ELS Level II). Enhanced security, resource accounting and system fault tolerance are features available to NetWare for Macintosh users.

A major benefit to Macintosh users is that NetWare for Macintosh ensures smooth operation with future enhancements to the AppleTalk Personal Network. Written "by the book" to conform with Apple's AppleTalk Filing Protocol (AFP) and Printer Access Protocol (PAP), NetWare for Macintosh was designed with Apple's technical assistance and in strict compliance to their standards. As Apple enhances AppleShare, NetWare for Macintosh is enhanced. Applications written to run on AppleShare run on NetWare for Macintosh. The first release of the product accommodates both the LocalTalk™ and EtherTalk™ Macintosh cabling schemes.

## Features

Users don't sacrifice "friendly" for "functional" with NetWare for Macintosh. Teamed with the NetWare server software is Apple's popular AppleShare workstation software. Users who are experienced with AppleShare require no retraining to use NetWare for Macintosh. To the Macintosh user, information stored on the network

server is listed using familiar Macintosh icons. Pictures of documents represent files, pictures of folders represent directories and pictures of folders within folders represent subdirectories. To other workstations on the network (PCs running DOS, OS/2 or Windows/386), directories, subdirectories and files are listed in the format of the workstation operating system.

File sharing is easy with NetWare for Macintosh. Files from both PC users and Macintosh users are stored in the same directories of the same network server. Users can open files from the server as easily as they open files from their local drives. PC files that share the same format as their Macintosh counterparts (like PageMaker®, Excel and ThinkTank/MORE) can be opened from either workstation. Easy-to-use translation utilities are available to translate files with incompatible formats.

Printer sharing is easy and economical with NetWare for Macintosh. Now PC users and Macintosh users can share Apple's LaserWriter® PostScript® printers. Sharing costly peripherals like laser printers makes business sense. NetWare's print spooling and print queue management features make the practice easy and efficient.

NetWare for Macintosh internetworking introduces countless opportunities for sharing resources and information across your office's existing networks - NetWare supports more than 30 PC-LAN topologies. Sharing printers, files and messages across like or unlike network topologies is transparent. LAN resources can be utilized by each member of every network with NetWare for Macintosh.

NetWare for Macintosh introduces a new universe of network services to Macintosh users. Enhanced security, resource accounting and system fault tolerance top the list of features that make NetWare for Macintosh the premium networking solution.

# NetWare FOR MACINTOSH

NETWARE  
FOR  
MACINTOSH



NOVELL®



The enhanced security feature's four levels of user access are the industry's most elaborate. Access can be limited to designated directories, to a specified Macintosh workstation or to specific hours of the day. Passwords are encrypted. Users can be required to periodically change their passwords, to use passwords that they have not used in the past, and to use passwords that are longer than a minimum length. Users can also be given a pre-determined number of tries at logging in before the system locks them out.

NetWare resource accounting allows system supervisors to monitor network use and bill user accounts accordingly. This feature allows the supervisor to:

- Set up an allowed credit limit for each user
- Let NetWare monitor account balances and logoff users with expired or depleted accounts
- Generate an audit trail of system use

Accounts can be charged for network services based on:

- Connection time
- Blocks read from disk
- Blocks written to disk
- Requests received from a workstation
- Amount of disk storage used.

Charges can be varied by time and by day.

System Fault Tolerant (SFT) NetWare includes the industry's most stringent collection of features designed to protect against system failure.

### Technical Specifications

Designed specifically for the Apple Macintosh, NetWare for Macintosh requires an 80286 or 80386 network server running NetWare v2.15 or higher.

AppleShare workstation software is included with NetWare for Macintosh. As a configuration option, NetWare for Macintosh can run on a NetWare bridge, separate from the network server.

### Hardware requirements:

Network workstations:

- Macintosh II, SE, Plus or 512e
- IBM PC XT, AT or compatibles
- IBM PS/2 Models 25, 30, 50, 60 or 80

Network server:

- Novell 286A, 286B or 386A
- IBM PC AT or compatibles
- IBM PS/2 Models 50, 60 or 80

NetWare network servers support disk drives with capacities as large as 256MB.

Total storage capacity of a single NetWare network server is 2GB.

Minimum network server memory: 2MB

All Macintosh models have a LocalTalk port. Connecting Macintoshes to LocalTalk LANs does not require a LocalTalk adapter. However, a LocalTalk adapter is required in the network server. Using the appropriate adapters, AppleTalk networks can also run Ethernet.

### For More Information

Call Novell NetWare Products Division,  
801-379-5900.

NetWare is a registered trademark of Novell, Inc. Hot Fix is a trademark of Novell, Inc. Apple, Macintosh, LaserWriter and AppleTalk are registered trademarks of Apple Computer, Inc. AppleShare, LocalTalk and EtherTalk are trademarks of Apple Computer, Inc. PostScript is a registered trademark of Adobe Systems, Inc. IBM is a registered trademark of International Business Machines Corporation. Other computer software names identified by ® or ™ are registered trademarks of their respective manufacturers.



**FACULTAD DE INGENIERIA U.N.A.M.  
DIVISION DE EDUCACION CONTINUA**

**INSTALACION Y MANEJO DE REDES (LAN) CON  
NETWARE DE NOVELL (PARTE III)**

**INSTALACION DEL HARDWARE**

**NOVIEMBRE, 1992**



# INSTALACION DEL HARDWARE

# ESTRUCTURA GENERAL

# ETHERNET



## CARACTERISTICAS

- CREADA POR XEROX (1970)
- ESTANDAR MAS ESTABLE
- MUCHOS AMBIENTES
- DIFICIL DE INSTALAR

apuntes

# ESTRUCTURA GENERAL

# ETHERNET



## ESPECIFICACIONES TECNICAS

<b>VELOCIDAD</b>	<b>10 MBITS/SEG</b>
<b>PROTOCOLO</b>	<b>CSMA/CD</b>
<b>NODOS</b>	<b>1 a 1023</b>
<b>CABLEADO</b>	<b>THICK (RG-11) 1500m</b>
	<b>THIN (RG-58) 300m</b>
	<b>FIBRA OPTICA</b>
	<b>TWISTED PAIR</b>

apuntes

# ESTRUCTURA GENERAL ETHERNET



## FABRICANTES MAS IMPORTANTES

- 3COM
- EXCELAN
- MICRON
- NOVELL
- GATEWAY

apuntes

# ESTRUCTURA GENERAL

# ETHERNET



## VARIANTES EN TARJETAS PARA PC

**-TAMAÑO DE BUFFER**

**-8 o 16 BITS**

**-USO DE DMA**

**-PROCESADOR**

apuntes



**FORMATO DEL FRAME**

<b>DIRECCION DESTINO</b>	<b>DIRECCION FUENTE</b>	<b>TIPO</b>	<b>DATOS</b>	<b>CRC</b>
------------------------------	-----------------------------	-------------	--------------	------------

apuntes



# ESTRUCTURA GENERAL

# ETHERNET



## CONFIGURACION TIPO EN THINLAN

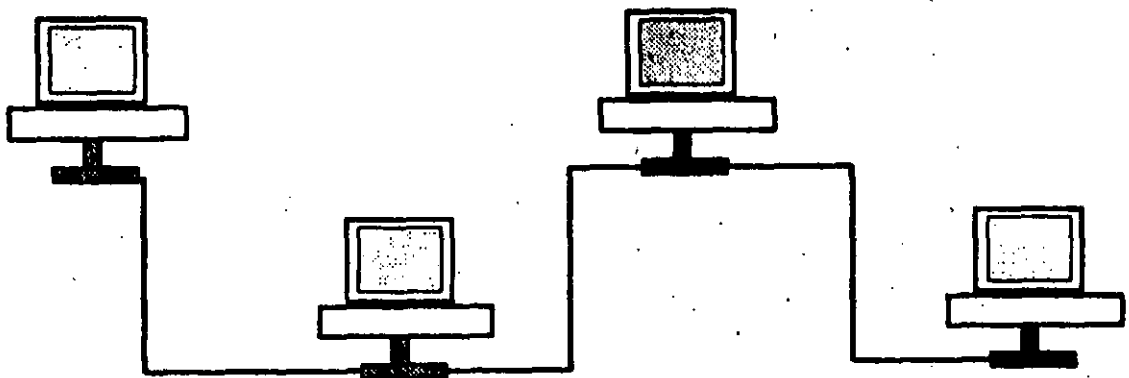

apuntes

# ETHERNET

- 10 MBits/segundo
- Estándar mas utilizado mundialmente
- Rendimiento más alto (High Performance)
- Múltiples opciones de cableado
  - coaxial delgado (RG-58)
  - par telefónico (Twisted Pair)
  - fibra óptica
  - coaxial grueso (RG-11)
- Cableado sencillo y económico
- Conectividad hacia otros sistemas bajo Ethernet

# ETHERNET

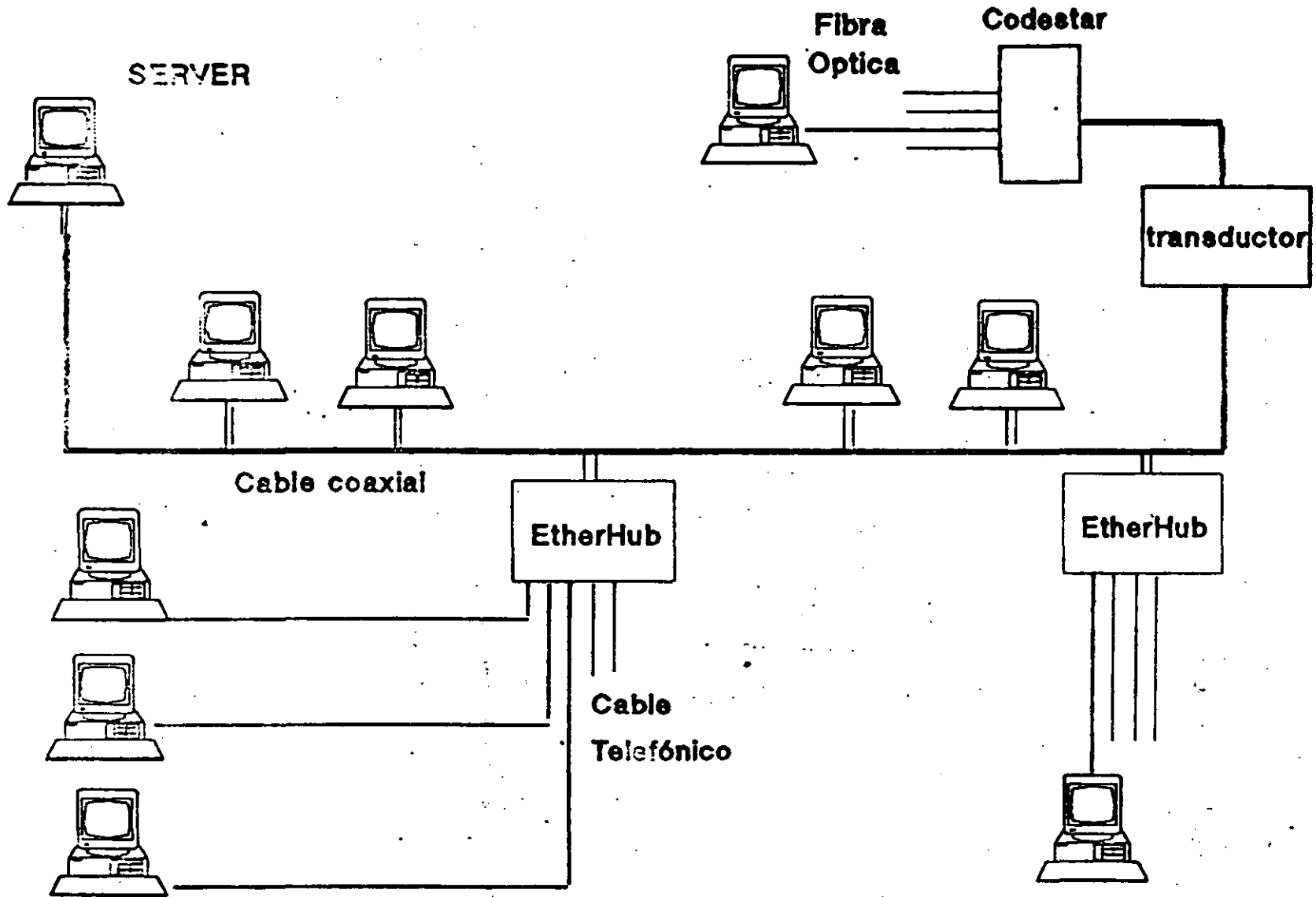

# ESTRUCTURA GENERAL

# TOKEN RING



## CARACTERISTICAS

- CREADA POR IBM
- ALTA CONECTIVIDAD EN IBM
- CABLEADO COMPLEJO
- BUEN RENDIMIENTO
- OPCION de 4/16 MB

apuntes

# ESTRUCTURA GENERAL

# TOKEN RING



## ESPECIFICACIONES TECNICAS

VELOCIDAD	4/16 MBITS/SEG
PROTOCOLO	TOKEN PASSING
NODOS	1023
INSTALACION	MAUs
CABLEADO	STP/IBM Tipo 2
	UTP
	FIBRA OPTICA

apuntes

# ESTRUCTURA GENERAL

# TOKEN RING



## FABRICANTES MAS IMPORTANTES

- 3COM
- IBM
- MICRON
- UNGERMAN-BASS
- PROTEON

apuntes

**ESTRUCTURA GENERAL** **TOKEN RING**



**FABRICACION**

El conjunto de Chips para Token Ring se desarrolló conjuntamente entre IBM y Texas Instruments. Casi todas las tarjetas Token Ring se basan en el Chipset de T.I. (TMS380)

apuntes

# ESTRUCTURA GENERAL TOKEN RING



## CONFIGURACION TIPO EN TOKEN-RING

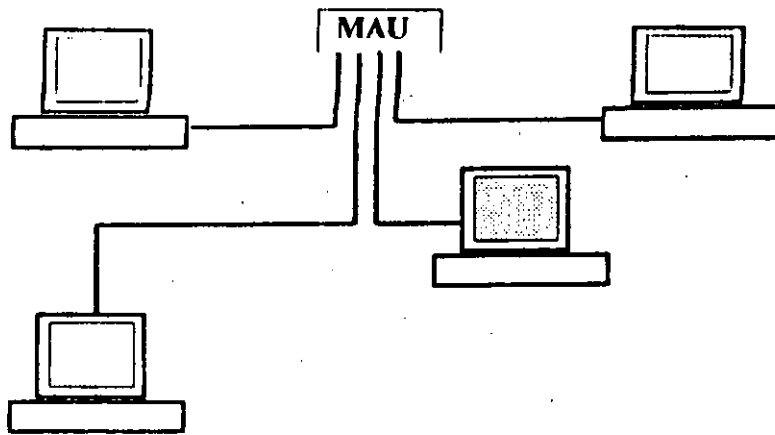

apuntes



# TOKEN-RING

- 4 MBits/segundo
- Topología de estrella distribuída
- Protocolo Token Passing
- Cable IBM tipo 2
- Conectividad hacia ambientes IBM 3270 bajo Token Ring

# TOKEN-RING

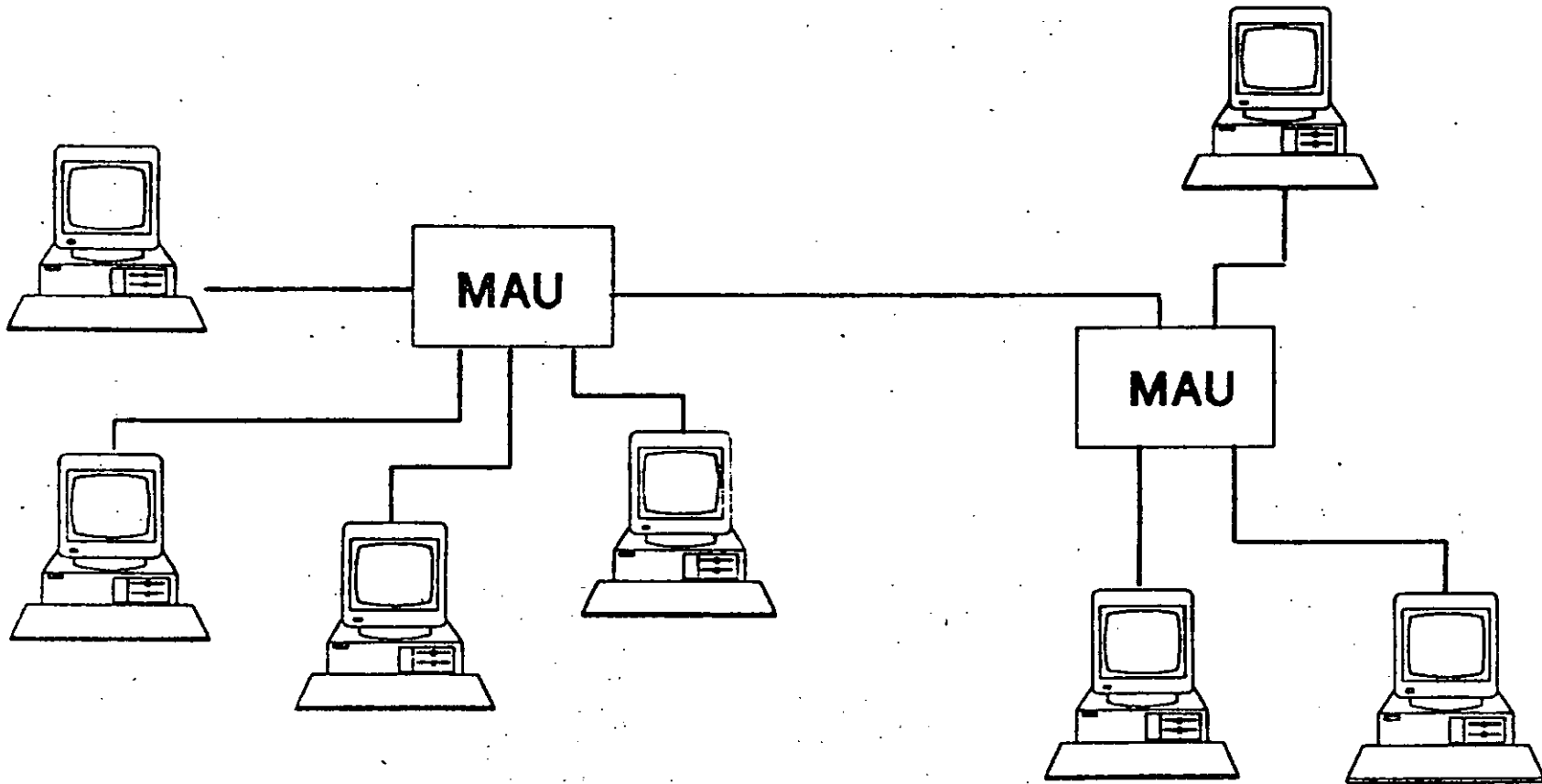



**CARACTERISTICAS**

- CREADA POR DATAPOINT
- MEJOR PRECIO/RENDIMIENTO
- CABLEADO MUY VERSATIL
- FACIL DE INSTALAR

apuntes

# ESTRUCTURA GENERAL

# ARCNET



## ESPECIFICACIONES TECNICAS

<b>VELOCIDAD</b>	<b>2.5 MBITS/SEG</b>
<b>PROTOCOLO</b>	<b>TOKEN-PASSING</b>
<b>NODOS</b>	<b>1 a 255</b>
<b>INSTALACION</b>	<b>REPETIDORES A/P</b>
<b>CABLEADO</b>	<b>RG-62 / BUS-STAR</b>
	<b>FIBRA OPTICA</b>
	<b>TWISTED PAIR</b>

apuntes

**ESTRUCTURA GENERAL**

**ARCNET**



**FABRICANTES MAS IMPORTANTES**

- MICRON
- DATAPOINT
- STANDARD MICROSISTEMS
- PURE DATA
- NOVELL
- THOMAS CONRAD

apuntes

# ESTRUCTURA GENERAL

# ARCNET



## SWITCHES

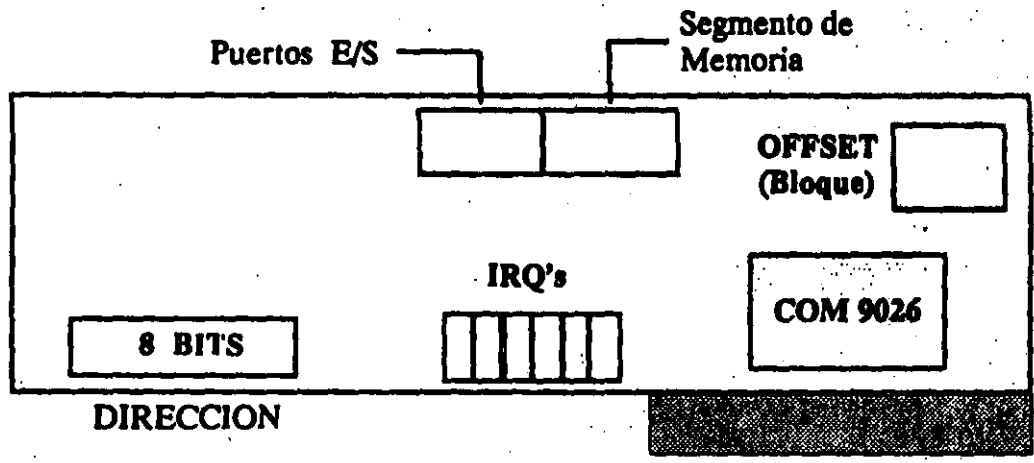

apuntes

# ESTRUCTURA GENERAL

# ARCNET



## FORMATO DEL FRAME

ALERT	SOH	SID	DID	DID	COUNT	DATOS	CRC	CRC
-------	-----	-----	-----	-----	-------	-------	-----	-----

apuntes

# ESTRUCTURA GENERAL

# ARCNET



## CONFIGURACION TIPO EN ARCNET

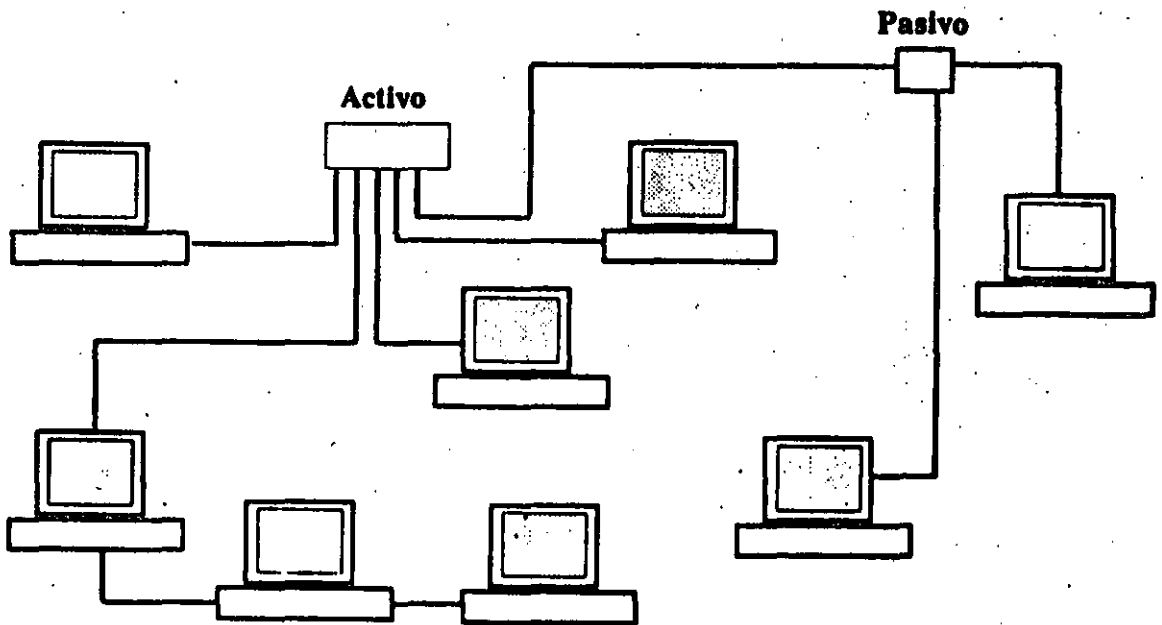

apuntes



# ARCNET

- 2.5 MBits/segundo
- Topología de estrella distribuida
- Protocolo Token-passing
- Cable coaxial delgado (RG-62)
- Bajo costo
- Permite distancias grandes (hasta 6km)

# ARCNET

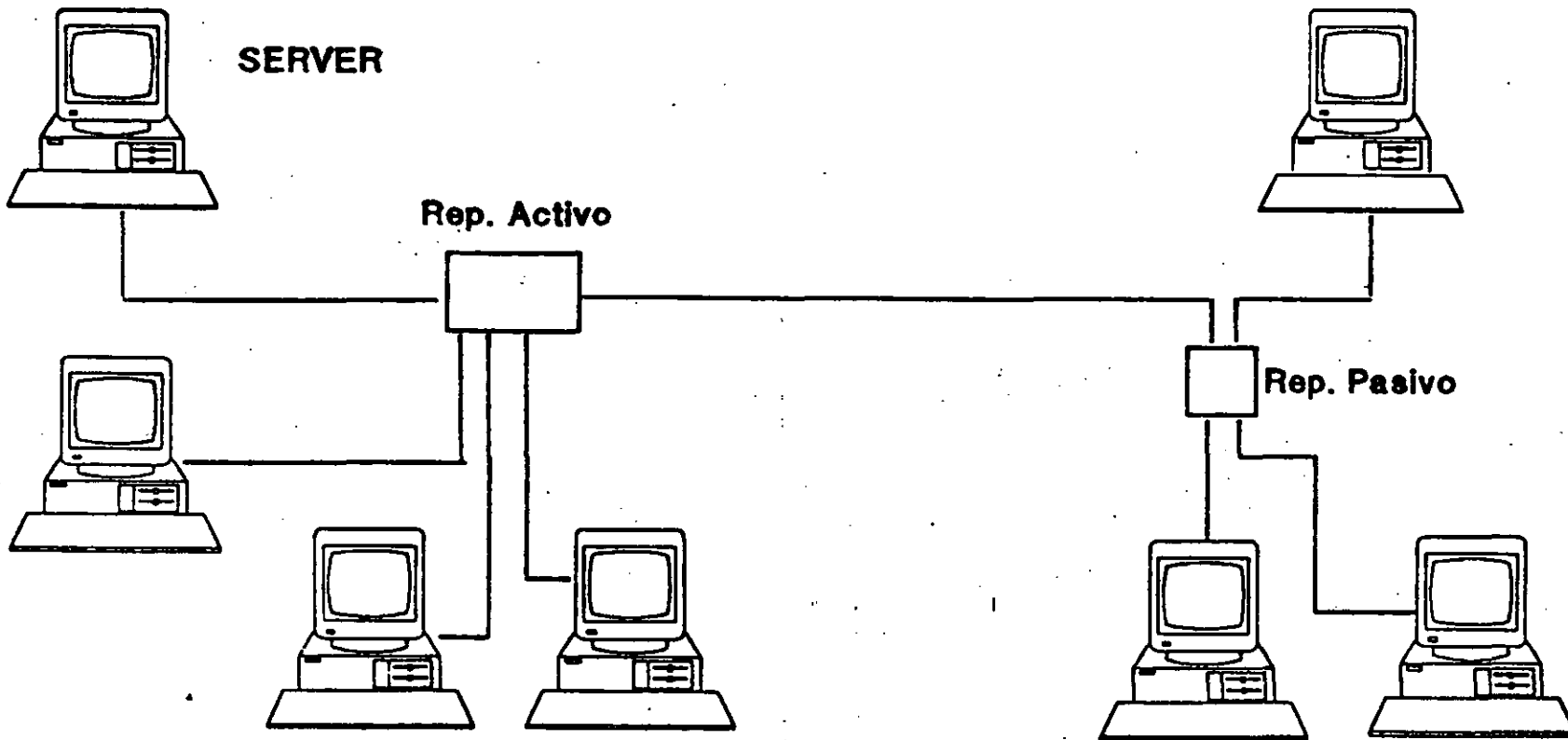

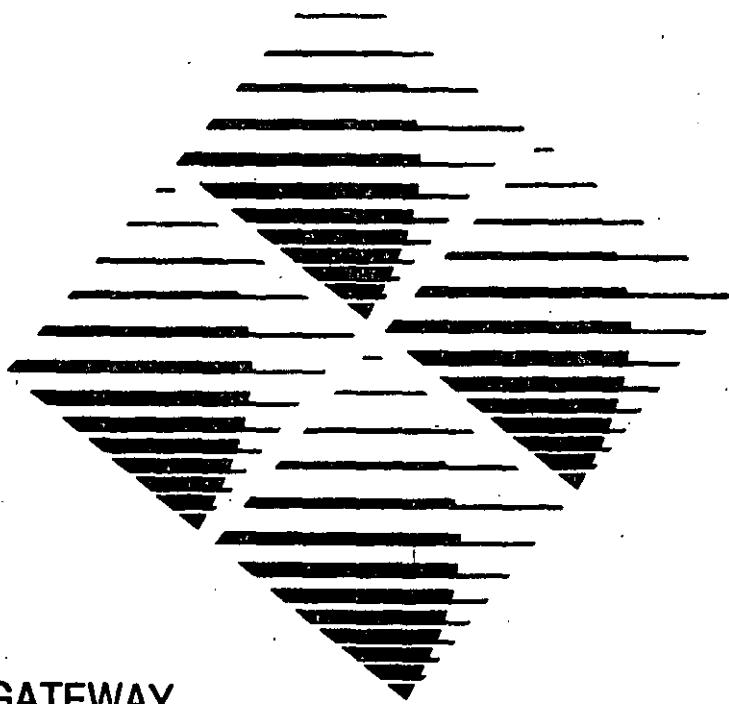

GATEWAY

COMMUNICATIONS

Installation

Guide

**G/Ethernet™ 8-bit PC Adapter**

**G/Ethernet™ 8-bit WS Adapter**

## FCC WARNING

This equipment generates, uses, and can radiate radio frequency energy and if not installed and used in accordance with the instruction manual, may cause interference to radio and television communications. It has been tested and found to comply with the limits for a Class A computing device pursuant to Subpart J of Part 15 of FCC Rules, which are designed to provide reasonable protection against such interference when operated in a commercial environment. Operation of this equipment in a residential area is likely to cause interference, in which case the user at his own expense will be required to take whatever measures may be required to correct the interference.

Fifth Edition (August 1989)

©1988, 1989, Gateway Communications, Inc. All rights reserved, including those to reproduce this book and software or parts thereof in any form without first obtaining written permission from Gateway Communications, Inc.

This book may contain technical inaccuracies or typographical errors. Every effort has been made to keep the information accurate and up to date. Changes are periodically made to the information herein, and these changes will be incorporated into new editions of this publication. Gateway Communications, Inc. makes no warranties as to the information in this book.

Ethernet is a trademark of Xerox Corporation.

G/X25 is a registered trademark of Gateway Communications, Inc. G/Ethernet, G/SNA Gateway and G/Remote Bridge are trademarks of Gateway Communications, Inc.

Compaq is a registered trademark of Compaq Computer Corporation.

IBM and PC DOS are registered trademarks, Personal System/2 and Micro Channel are trademarks of International Business Machines Corporation.

Novell and NetWare are registered trademarks of Novell, Inc.

3Com, 3+Share are registered trademarks of 3Com Corporation

---

---

# CONTENTS

---

---

## 1 INTRODUCTION

TO THE INSTALLER .....	1-1
README File .....	1-2
Configuration/Installation Summary .....	1-2
SYSTEM REQUIREMENTS .....	1-2
Network Operating Systems .....	1-2
Hardware Requirements .....	1-3
Software Requirements .....	1-3
PACKAGE CONTENTS .....	1-3

## 2 CONFIGURING THE ADAPTER

SELECTING THE CABLE TYPE .....	2-1
SELECTING THE INTERRUPT REQUEST LINE .....	2-1
SELECTING THE DEVICE I/O ADDRESS .....	2-3
SETTING THE AUTOBOOT PROM ADDRESS .....	2-4
SELECTING COMPATIBILITY .....	2-5
SELECTING THE SOFTWARE CONFIGURATION .....	2-5
Using the SET Command for NetWare Workstations .....	2-6

## 3 INSTALLING THE ADAPTER

INSTALLING THE AUTOBOOT PROM .....	3-1
INSTALLING THE G/ETHERNET ADAPTER .....	3-3

## 4 INSTALLING DRIVERS

ABOUT THE DRIVERS DISKETTE .....	4-1
INSTALLING WORKSTATION DRIVERS FOR NETWARE V2.0A .....	4-2
INSTALLING WORKSTATION DRIVERS FOR NETWARE V2.11 and V2.12 .....	4-3
INSTALLING WORKSTATION DRIVERS FOR NETWARE V2.15 AND ELS LEVEL II .....	4-4

Using the Standard Floppy Disk Method ..... 4-4

Using the Hard Disk or Network Drive Method ..... 4-5

    If SHGEN Has Never Been Installed ..... 4-5

    If SHGEN Has Previously Been Installed ..... 4-5

**INSTALLING FILE SERVER DRIVERS FOR NETWARE V2.0A ..... 4-7**

**INSTALLING FILE SERVER DRIVERS FOR NETWARE V2.11 AND V2.12 ..... 4-8**

**INSTALLING FILE SERVER DRIVERS FOR NETWARE V2.15 AND ELS LEVEL II ..... 4-9**

    Using the RAM Disk or Standard Floppy Disk Method .... 4-9

    Using the Hard Disk or Network Drive Methods ..... 4-10

        If NetWare Has Never Been Installed ..... 4-10

        If NetWare Has Previously Been Installed ..... 4-10

**INSTALLING EXTERNAL BRIDGE DRIVERS FOR NETWARE V2.11 AND V2.12 ..... 4-12**

**INSTALLING EXTERNAL BRIDGE DRIVERS FOR NETWARE V2.15 ..... 4-13**

    Using the Standard Floppy Disk Method ..... 4-13

    Using the Hard Disk or Network Drive Methods ..... 4-14

**INSTALLING WORKSTATION DRIVERS FOR 3+SHARE . 4-15**

**DIAGNOSTICS**

**RUNNING THE DIAGNOSTIC PROGRAM ..... 5-1**

**ERROR MESSAGES ..... 5-3**

**TROUBLESHOOTING**

**CHECKLIST ..... 6-1**

**SYMPTOMS ..... 6-1**

**Figures**

Figure 2-1. G/Ethernet 16-bit Component Locations. .... 2-2

Figure 3-1. Installing the Autoboot PROM. .... 3-2

**Tables**

Table 2-1. Device I/O Address Selections. .... 2-3

Table 2-2. Autoboot PROM Address Ranges. .... 2-4

Table 2-3. Predefined Address Selections. .... 2-5

h

UNIVERSITY MICROFILMS  
SERIALS ACQUISITION  
300 N ZEEB RD  
ANN ARBOR MI 48106

Gateway's G/Ethernet 16-bit adapter combines the industry-standard Ethernet<sup>®</sup> with added features to enhance your network's speed and performance. G/Ethernet conforms to the IEEE 802.3 standard for data transfer, making it compatible with most other Ethernet LANs that conform to this standard and use one of several versions of NetWare<sup>®</sup> or 3Com<sup>®</sup> 3+Share<sup>®</sup> network operating systems.

Each adapter comes pre-configured so you can simply install it, cable it, and use it. To enhance flexibility, several configurable options are available. G/Ethernet supports thin, standard, and fiber optic Ethernet cable.

Gateway also offers an 8-bit adapter for use in an IBM PC, PC-XT, PC-AT, or Personal System/2™ Model 30 workstation or file server, plus a Micro Channel™ adapter for use in an IBM Personal System/2 Model 50, 60, 70, or 80 workstation or file server. An Autoboot PROM chip that allows a workstation with no local drives to boot from the file server is also available for the 16-bit adapter.

## **TO THE INSTALLER**

This manual contains the instructions for configuring and installing Gateway's G/Ethernet 16-bit AT Adapter. It was written assuming that you are familiar with PC DOS<sup>®</sup>, your network operating system, and the computer in which you are installing the adapter.

The manual is organized so that you can follow each section in sequence. Browse through the Table of Contents to become familiar with the topics in this manual, then read "Package Contents" in this section to verify the G/Ethernet 16-bit package contains the correct items.

## README File

Occasionally, changes are made to the software or additional information becomes available after the manual is printed. These changes will be documented in a README file on the G/Ethernet Drivers diskette that comes with the package.

Use the DOS DIR command to locate any README files on the diskette, then use the DOS TYPE command to examine the file. To print the file use the DOS PRINT command.

## Configuration/Installation Summary

Following is a summary of the steps required to configure and install the G/Ethernet 16-bit adapter.

1. Determine whether or not you can use the default configuration. If not, use Section 2 to select new options.
2. Install the G/Ethernet adapter and connect the network cable according to the instructions in Section 3.
3. Install the G/Ethernet driver according to the instructions in Section 4. Then generate the workstation shell or file server operating system, and create the boot diskette.
4. To verify that the 16-bit adapter is functioning properly, run the diagnostics program by following the instructions in Section 5.

If you have any problems after installing the LAN, refer to Section 7 for a list of error messages, symptoms of problems, suggested solutions, and techniques for isolating a problem.

## SYSTEM REQUIREMENTS

This section lists compatible network operating systems, other software requirements, and hardware requirements.

### Network Operating Systems

- The G/Ethernet 16-bit adapter is compatible SFT and Advanced NetWare versions 2.0a, 2.11, 2.12, 2.15, and ELS Level II, plus 3Com 3+Share.

The 16-bit adapter can be configured as a NetWare or 3+Share workstation, a NetWare file server, or a NetWare external bridge (v2.11, v2.12, and v2.15).

### Hardware Requirements

The G/Ethernet 16-bit adapter can be installed in a 16-bit expansion slot in an IBM PC-AT.

### Software Requirements

The G/Ethernet 16-bit adapter requires PC DOS version 3.1 or later, or a MS-DOS equivalent.

## PACKAGE CONTENTS

Each G/Ethernet 16-bit Adapter package contains the following components:

- One G/Ethernet 16-bit AT Adapter
- One BNC T-connector
- One G/Ethernet Drivers diskette (LAN\_DRV\_207)
- *G/Ethernet 16-bit AT Adapter Installation manual*



---

---

## 2 CONFIGURING THE ADAPTER

---

---

This section contains the information necessary to configure the hardware options on the G/Ethernet adapter.

Figure 2-1 shows the location of each component with its default set. If you can use the defaults, compare the G/Ethernet adapter with the illustration in Figure 2-1 to verify that the hardware options are set properly. Be sure that switches 7 and 8 are in the off position. If the hardware options are set properly, skip to the next section and install the adapter.

### SELECTING THE CABLE TYPE

The cable type selection jumper, JP4, allows you to select either thick or thin cable types. JP4 has three rows of four pins with four jumpers installed. Choose the cable type by setting the four jumpers as shown in Figure 2-1, either all connecting the top and middle pins (thin Ethernet, the default), or all connecting the middle and lower pins (thick Ethernet).

### SELECTING THE INTERRUPT REQUEST LINE

The IRQ line signals the PC that the device needs attention. A circuit is created by strapping (jumping) two pins together, thereby connecting the interrupt circuitry of the G/Ethernet adapter to a specific PC interrupt request line. Jumper JP2 sets the interrupt.

Figure 2-1 illustrates the location of JP2 with IRQ 3 (default) set. IRQ 2, IRQ 4, IRQ 5, IRQ 6, IRQ 7, IRQ 10, IRQ 11, IRQ 12, and IRQ 15 are also available.

Table 2-3 lists the IRQ and device I/O address combinations that are selectable through the NetWare installation process. Be sure that the IRQ and device I/O setting you have selected matches one of those combinations. Note that even though IRQ 4 and IRQ 6 are available on the adapter, they are not valid software selections. Refer to *Selecting the Software Configuration* in this section for more details.

If you have installed an Autoboot PROM, you must select IRQ 3.

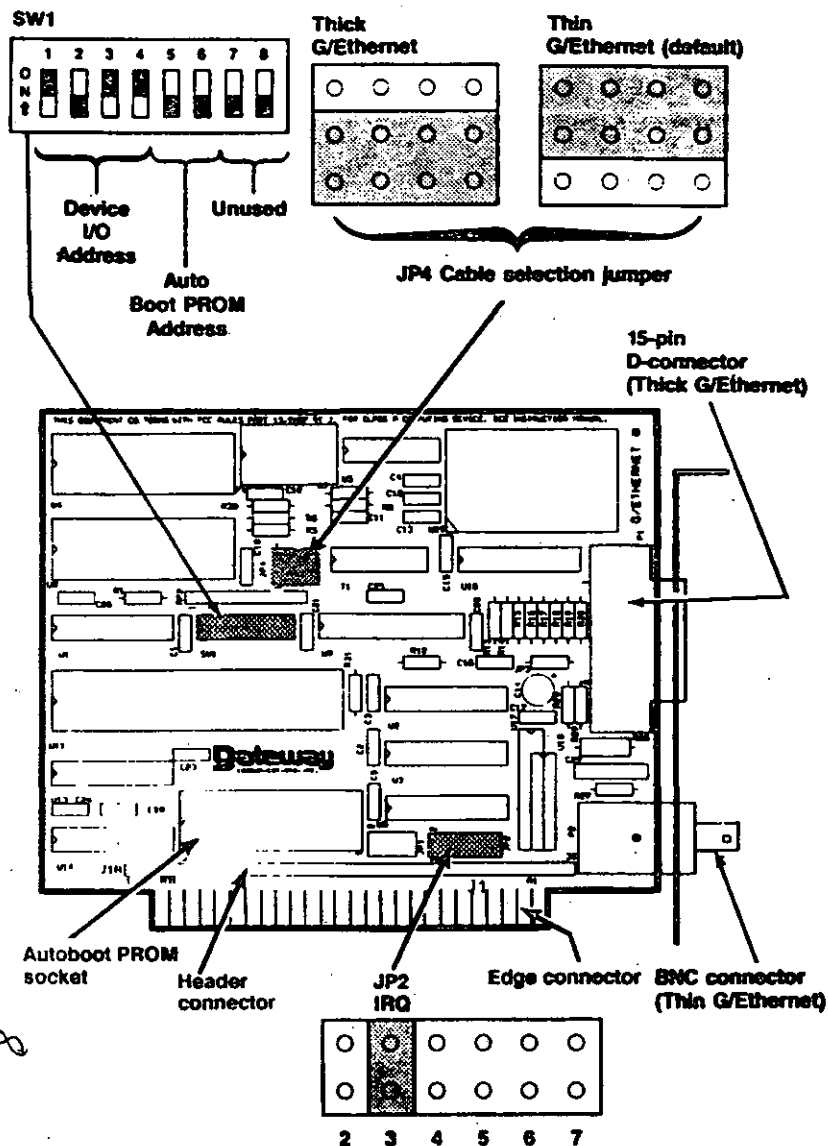

Figure 2-1. G/Ethernet 16-bit Component Locations.

### SELECTING THE DEVICE I/O ADDRESS

The device I/O address allows the PC to locate and differentiate between installed devices. Switches 1, 2, 3, and 4 of switch block SW1 set the device I/O address. The default is 002A0-002BF (hexadecimal). Table 2-1 lists the available device I/O address ranges and their correct switch positions.

If you have installed an Autoboot PROM, select device I/O address 2A0h.

Table 2-1. Device I/O Address Selections.

Address Range	SW1-1	SW1-2	SW1-3	SW1-4
00280-0029F	ON	ON	ON	ON
002A0-002BF (1)	ON	OFF	ON	ON
002C0-002DF (2)	ON	ON	OFF	ON
002E0-002FF	ON	OFF	OFF	ON
00300-0031F (3)	ON	ON	ON	OFF
00320-0033F	ON	OFF	ON	OFF
00360-0037F (4)	ON	OFF	OFF	OFF

NOTES:

- (1) Default
- (2) Both IRQ2 and IRQ3 are available with this address
- (3) Possible conflict with some tape devices
- (4) IBM LAN default

Table 2-3 lists the IRQ and device I/O address combinations that are selectable through the NetWare software installation process. Be sure that the device I/O and IRQ setting you have selected matches one of those combinations. Refer to Selecting the Software Configuration in this section for more details.

## SETTING THE AUTOBOOT PROM ADDRESS

The Autoboot PROM address allows the PC to locate the Autoboot PROM. If you cannot use the default, CC000h-CFFFFh, select a new address by setting switches 5 and 6 of switch block SW1 (Figure 2-1) according to the Table 2-2.

The Autoboot PROM requires IRQ 3 and device I/O address 2A0h.

Table 2-2. Autoboot PROM Address Ranges.

Address Range	SW1-5	SW1-6
C0000-C3FFF (1)	ON	ON
C4000-C7FFF (2)	OFF	ON
C8000-CBFFF (2)	ON	OFF
CC000-CFFFF* (2)	OFF	OFF

NOTES:

\* Default address

(1) Possible conflict with hard disk controller or VGA and EGA adapters

(2) Possible conflict with EMS memory or LAN adapters

## SELECTING COMPATIBILITY

The G/Ethernet 16-bit adapter is compatible with most PC motherboards. If you experience intermittent failures when booting the PC, the PC locks up, or you receive continuous network error messages, and you cannot attribute these problems to incorrect software installation, poor cable connection, or faulty hardware, then you may need to change the compatibility jumper, JP5.

JP5 has one column of three pins with one jumper installed. Select position A (default) by strapping the top and middle pins (Figure 2-1). Select position B by strapping the middle and bottom pins.

If the problem still occurs refer to the Diagnostic and the Troubleshooting sections of this manual.

## SELECTING THE SOFTWARE CONFIGURATION

During the NetWare installation process, you will need to select the IRQ and device I/O settings to match the adapter. Table 2-3 lists the combinations that will display for the NetWare Configure Drivers/Resource option. Verify that one of these combinations matches the adapter's hardware settings.

Table 2-3. Predefined Address Selections.

Number	Configuration Definition	Conflicting Devices
0*	IRQ 3, Device I/O Address 002A0h	COM2 (IRQ only)
1	IRQ 5, Device I/O Address 00280h	Tape Controller
2	IRQ 3, Device I/O Address 002E0h	COM2
3	IRQ 5, Device I/O Address 00320h	XT hard disk cont.
4	IRQ 7, Device I/O Address 00360h	LPT1
5	IRQ 3, Device I/O Address 00300h	COM2 (IRQ only)
6	IRQ 3, Device I/O Address 002C0h	COM2 (IRQ only)
7	IRQ 2, Device I/O Address 002C0h	EGA (IRQ only)

\* Default

## Using the SET Command for NetWare Workstations

The G/Ethernet workstation driver allows you to use the DOS SET command for the environment variable GETHER to select a predefined IRQ and device I/O setting. Table 2-3 lists the available predefined configurations.

The SET command *must* be used to configure the software for NetWare v2.0a workstations and *cannot* be used when configuring a NetWare file server (any version). Note that the SET GETHER command overrides the NetWare software configuration.

To change the software configuration, set the environment variable GETHER to equal the predefined configuration number. For example, if you want to use configuration number 4, enter the following command in the AUTOEXEC.BAT file:

```
SET GETHER=4
```

Place the DOS SET command in the AUTOEXEC.BAT file before the ANET3 (v2.0a) or IPX and NET3 (v2.1x) commands.

Be sure that the adapter's IRQ and device I/O settings match the predefined configuration you have selected.

---

---

## 3 INSTALLING THE ADAPTER

---

---

This section provides installation instructions for the Autoboot PROM and G/Ethernet 16-bit AT adapter. The adapter should have already been configured according to the guidelines in Section 2.

### INSTALLING THE AUTOBOOT PROM

If you did not purchase the optional Autoboot PROM, skip this subsection and proceed to Installing the G/Ethernet Adapter.

Before handling the Autoboot PROM, discharge any static electricity on your body by touching a grounded surface such as the chassis of the PC.

**STEP 1:** Locate the Autoboot PROM socket on the G/Ethernet adapter (Figure 2-1). It is toward the center of the adapter.

#### CAUTION

*Do not touch the components or the reverse side (solder side) of the adapter. Damage to the chips could occur due to electrostatic discharge and cause the adapter to malfunction.*

**STEP 2:** Orient the chip properly. Align the notch on the PROM with the notch on the socket. Gently insert the PROM into the socket until it is firmly seated.

If the chip's pins are too wide to fit into the socket, place the chip on its side on a flat surface and gently angle it under both thumbs to slightly bend the pins inward. Figure 3-1 illustrates the correct method of installing the PROM.

**STEP 3:** Create a boot image file for the workstation. Use the instructions in Section 9 of the *SFT Advanced NetWare Supervisor's Guide*, "Creating Remote Reset Boot Files".

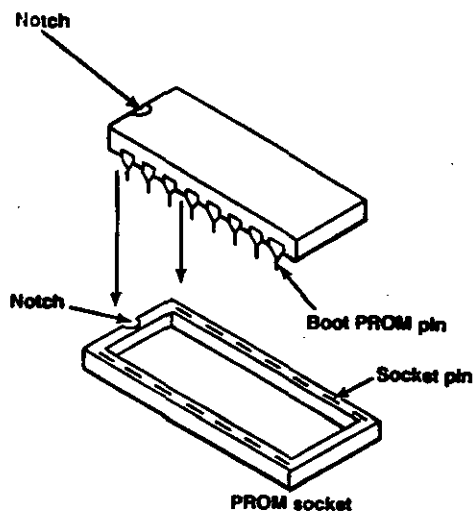

Figure 3-1. Installing the Autoboot PROM.

## INSTALLING THE G/ETHERNET ADAPTER

Depending on the mechanical fasteners used in your PC, you will need one or more of the following tools: a slim, flatblade screwdriver; a Phillips screwdriver; a nutdriver; or if you are installing the adapter in a Compaq®, you will need a Torx® driver.

### CAUTION

*Before installing the adapter, turn the system power off and unplug any power cord connected to a wall outlet. Turn off any other devices connected to the computer. Installing any component while the power is on can permanently damage your computer and its components.*

- STEP 1:** Remove the PC cover according to the manufacturer's instructions.
- STEP 2:** Select an unused 16-bit expansion slot. Remove the bracket retaining screw and metal slot cover mounted on the rear panel.
- STEP 3:** Install the adapter. Arrange the adapter so that the edge connector is aligned with the expansion slot receptacle. Using evenly distributed pressure, insert the adapter straight down until it seats in the expansion slot.

### CAUTION

*Do not touch the components or the reverse side (solder side) of the adapter. Damage to the chips could occur due to electrostatic discharge and cause the adapter to malfunction.*

Note that slight adjustments may be necessary when installing the adapter since all personal computers are not designed to the same specification.

- STEP 4:** Fasten the adapter's mounting bracket at the top of the rear bracket slot by replacing the screw you removed in Step 2.

**STEP 5:** Replace the cover, AC power cord, and any other device you previously disconnected.

After installing the adapter, attach the network cable, then install the driver software according to the instructions in Section 4.

---

---

## 4 INSTALLING DRIVERS

---

---

This section discusses the installation of workstation and file server drivers for NetWare versions 2.0a, 2.11, 2.12, v2.15, and ELS NetWare 286 Level II, plus 3Com 3+Share workstation drivers for the G/Ethernet 8-bit WS and 8-bit PC adapter.

These procedures are divided according to the version of NetWare you are using; v2.0a, v2.11, v2.12, v2.15, ELS Level II, or 3Com 3+Share.

Driver installation procedures are identical for LANs running NetWare v2.11 and v2.12, so the instructions are combined. Installation procedures are also identical for LANs using NetWare v2.15 and ELS Level II.

Use the instructions in the *SFT/Advanced NetWare 286 Installation*, *ELS Level II Installation*, or 3+Share installation manual to generate software and create the boot diskette, and the instructions in this manual to install the drivers.

### ABOUT THE DRIVERS DISKETTE

The G/Ethernet Drivers diskette is divided into several subdirectories, each containing the drivers and other necessary files for each version of NetWare and 3+Share. NetWare versions 2.11, 2.12, 2.15, and ELS Level II use the same drivers, whereas NetWare v2.0 uses different drivers. The location of each set of drivers on the G/Ethernet Drivers diskette is as follows:

- Workstation and file server drivers for NetWare v2.0a are located in the GETH\_20A subdirectory.
- Workstation and file server drivers for NetWare v2.11, 2.12, 2.15, and ELS Level II are located in the root directory.
- Workstation drivers for 3+Share are located in the 3Com subdirectory.

The exact location of the driver for each adapter will be noted in the appropriate subsection.

## INSTALLING WORKSTATION DRIVERS FOR NETWARE V2.0A

The driver installation procedure involves copying the G/Ethernet workstation driver onto the GENSH-1 diskette then generating the NetWare workstation shell.

Use the following steps in conjunction with the instructions for generating the workstation shell in the NetWare installation manual.

**STEP 1:** Make sure that there is enough space on the GENSH-1 diskette. Insert the GENSH-1 diskette in drive A:, and the G/Ethernet Drivers diskette in drive B:.

Run a directory of the GENSH-1 diskette. If you have less than 6500 bytes of available disk space, delete an unused driver subdirectory to make room for the G/Ethernet drivers. Do not erase any GENSH-1 files.

**STEP 2:** Create a subdirectory called GETHERAT on the GENSH-1 diskette by typing

```
A:MD\GETHERAT <Enter>
```

**STEP 3:** Copy the G/Ethernet workstation driver, SHELLDRV.OBJ, from the WS\_AT subdirectory on the G/Ethernet Drivers diskette into the GETHERAT directory. Type the following command then press <Enter>.

```
COPY B:\WS_AT\SHELLDRV.OBJ A:\GETHERAT
```

**STEP 4:** Start the GENSH utility according to the instructions in the NetWare installation manual. When prompted for the adapter, select "G/Ethernet AT Adapter by Gateway Communications".

**STEP 5:** Add the DOS SET command to the AUTOEXEC.BAT file and set the GETHER variable to equal the IRQ and device I/O combination that matches the adapter's configuration. Refer to Table 2-3 for the valid combinations.

Proceed with the instructions in the NetWare installation manual to complete the procedure.

## INSTALLING WORKSTATION DRIVERS FOR NETWARE V2.11 and V2.12

Use the following procedure in conjunction with the instructions for generating the workstation shell in the NetWare installation manual.

You will need a working copy of the G/Ethernet Drivers diskette. (LAN\_DRV\_207) and the appropriate NetWare diskettes.

**STEP 1:** Make sure that there is enough space on the SHGEN-1 diskette. Insert the SHGEN-1 diskette in drive A: and the G/Ethernet Drivers diskette in drive B:.

Run a directory of the SHGEN-1 diskette. If you have less than 700 bytes of available disk space, delete any unnecessary files to make room for the drivers. Do not erase any SHGEN files.

**STEP 2:** Copy the G/Ethernet shell pointer file, GEATSH.LAN, from the drivers diskette onto the NetWare SHGEN-1 diskette. Type

```
COPY B:GEATSH.LAN A: <Enter>
```

The remaining .OBJ files stay on the G/Ethernet Drivers diskette and will be used during the SHGEN procedure.

**STEP 3:** Start the SHGEN utility according to the instructions in the NetWare installation manual. When prompted, insert the LAN\_DRV\_207 (G/Ethernet Drivers) diskette and select "G/Ethernet AT Adapter by Gateway Communications" from the list of LAN adapter options.

**STEP 4:** Select the "Configure Drivers/ Resources" option from the NetWare menu. Specify the adapter's configuration from the "Available Resource Configurations" window by selecting the IRQ and device I/O combination.

Proceed with the instructions in the NetWare installation manual to complete the procedure.

## INSTALLING WORKSTATION DRIVERS FOR NETWARE V2.15 AND ELS LEVEL II

The installation procedures for NetWare v2.15 and ELS Level II are identical, so the instructions are combined. This section describes two methods of installing the drivers:

- Installing drivers using the Standard Floppy Disk method
- Installing drivers using the Hard Disk or Network Drive method

For either of these procedures, you will need a working copy of the G/Ethernet Drivers diskette, plus the appropriate NetWare diskettes.

### Using the Standard Floppy Disk Method

Use the following instructions in conjunction with those in the *SFT/Advanced NetWare Installation* or *ELS Level II Installation* manual.

- STEP 1:* Start the SHGEN procedure according to the instructions in the NetWare installation manual.
- STEP 2:* Select "Custom Shell Generation Level".
- STEP 3:* When the LAN Driver Options menu appears, select "Load and Select Item". The following prompt will appear:
- Insert disk matching LAN\_DRV\_??? in any drive
- Insert the G/Ethernet Drivers diskette and press <Esc>.
- STEP 4:* When the Available LAN Drivers window appears, select "G/Ethernet AT Adapter by Gateway Communications".
- STEP 5:* Select the "Configure Drivers/ Resources" option from the NetWare menu. Specify the adapter's configuration from the "Available Resource Configurations" window by selecting the IRQ and device I/O combination.

Proceed with the instructions in the NetWare installation manual to complete the process.

### Using the Hard Disk or Network Drive Method

Use the following instructions in conjunction with those in the *SFT/Advanced NetWare Installation* or *ELS Level II Installation* manual.

#### If SHGEN Has Never Been Installed

- STEP 1:* Start the SHGEN procedure according to the instructions in the NetWare installation manual.
- STEP 2:* Select "Custom Shell Generation Level".
- STEP 3:* When the following message appears
- Upload Additional Diskettes?
- Highlight Yes and press <Enter>.
- Insert the LAN\_DRV\_207 (G/Ethernet Drivers) diskette in drive A: and press <Esc>. The drivers will be copied from the LAN\_DRV\_207 diskette onto the hard drive.
- STEP 4:* When the LAN Driver Options menu appears, select "Load and Select Item".
- STEP 5:* When the Available LAN Drivers window appears, select "G/Ethernet AT Adapter by Gateway Communications".
- STEP 6:* Specify the adapter's configuration by selecting the "Configure Drivers/ Resources" option from the NetWare menu. From the "Available Resource Configurations" window select the IRQ and device I/O combination.

Proceed with the instructions in the NetWare installation manual to complete the process.

#### If SHGEN Has Previously Been Installed

- STEP 1:* If the SHGEN files have been installed in a subdirectory:
- Create a subdirectory within the NetWare directory for the G/Ethernet drivers. Type
- MD\netware\LAN\_DRV\_207 <Enter>



where

*netware* is the name of the subdirectory the SHGEN.EXE files and NetWare subdirectories are located.

Be sure to place a period before 207.

If the SHGEN files have been installed in the root directory:

From the root directory, create a subdirectory for the drivers. Type

```
MD\LAN_DRV_.207 <Enter>
```

Be sure to place a period before 207.

- STEP 2:** Copy the contents of the root directory from the G/Ethernet Drivers diskette into the LAN\_DRV\_.207 subdirectory.
- STEP 3:** Start the SHGEN utility according to the instructions in the NetWare installation manual. Select "Custom Shell Generation Level".
- STEP 4:** When the LAN Driver Options menu appears, select "Load and Select Item".
- STEP 5:** When the Available LAN Drivers window appears, select "G/Ethernet AT Adapter by Gateway Communications".
- STEP 6:** Specify the adapter's configuration by selecting the "Configure Drivers/ Resources" option from the NetWare menu. From the "Available Resource Configurations" window select the IRQ and device I/O combination.

Proceed with the instructions in the NetWare installation manual to complete the process.

## INSTALLING FILE SERVER DRIVERS FOR NETWARE V2.0A

The file server drivers for NetWare v2.0a are located in the FS\_AT subdirectory within the GETH\_20A directory of the G/Ethernet Drivers diskette. The GETH\_20A directory also includes subdirectories with workstation and file server drivers for several other G/Ethernet adapters.

For this procedure, you will need working copies of the G/Ethernet Drivers diskette and the appropriate NetWare diskettes.

- STEP 1:** Make sure that there is enough space on the GENOS-1 diskette. Insert the GENOS-1 diskette in drive A: and the G/Ethernet Drivers diskette in drive B:.
- Run a directory of the GENOS-1 diskette. If you have less than 21000 bytes of available disk space, delete an unused driver subdirectory to make room for the drivers. Do not erase any GENSH-1 files.
- STEP 2:** Create a subdirectory called GETHERAT on the GENOS-1 diskette by typing
- ```
A:MD\GETHERAT <Enter>
```
- STEP 3:** Copy the following 2.0a file server drivers into the GETHERAT subdirectory:
- ```
ACOMDRV.OBJ
BCOMDRV.OBJ
CCOMDRV.OBJ
DCOMDRV.OBJ
```
- by typing
- ```
COPY B:?\COMDRV.OBJ A:\GETHERAT <Enter>
```
- STEP 4:** Start the GENOS utility according to the instructions in the NetWare installation manual. Select "G/Ethernet AT Adapter by Gateway Communications" from the list of LAN adapter options.
- STEP 5:** Select the "Configure Drivers/ Resources" option from the NetWare menu. Specify the adapter's configuration from the "Available Resource Configurations" window by selecting the IRQ and device I/O combination.

## INSTALLING FILE SERVER DRIVERS FOR NETWARE V2.11 AND V2.12

NetWare versions 2.11 and 2.12 use the same operating system pointer files and therefore, the installation procedures are the same.

You will need a working copy of the G/Ethernet Drivers diskette, plus the necessary NetWare diskettes.

**STEP 1:** Make sure that there is enough space on the AUXGEN diskette. Insert the AUXGEN diskette in drive A: and the G/Ethernet Drivers diskette in drive B:.

Run a directory of the AUXGEN diskette. If you have less than 700 bytes of disk space available, delete any unnecessary files to make room for the drivers. Do not erase any AUXGEN files.

**STEP 2:** Copy the operating system pointer file, GEATOS.LAN, from the root directory of the G/Ethernet drivers diskette onto the AUXGEN diskette by typing

```
COPY B:GEATOS.LAN A: <Enter>
```

The remaining .OBJ files stay on the G/Ethernet Drivers diskette and will be used during the NETGEN procedure.

**STEP 3:** Start the NETGEN utility according to the instructions in the NetWare installation manual. When prompted, insert the LAN\_DRV\_207 (G/Ethernet Drivers) diskette and select "G/Ethernet AT Adapter by Gateway Communications" from the list of LAN adapter options.

**STEP 4:** Specify the adapter's configuration by selecting the "Configure Drivers/ Resources" option from the NetWare menu. From the "Available Resource Configurations" window select the IRQ and device I/O combination.

Proceed with the instructions in the NetWare installation manual to complete the process.

## INSTALLING FILE SERVER DRIVERS FOR NETWARE V2.15 AND ELS LEVEL II

The installation procedures for NetWare v2.15 (NETGEN) and ELS Level II (ELSGEN) are identical, so the instructions are combined. This section describes two methods of driver installation:

- Using the RAM Disk and Standard Floppy Disk methods
- Using the Hard Disk and Network Drive methods

For either of these procedures, you will need a working copy of the G/Ethernet Drivers diskette, plus the appropriate NetWare diskettes.

### Using the RAM Disk or Standard Floppy Disk Method

Use these instructions in conjunction with either the *SFT/Advanced NetWare Installation* or *ELS Level II Installation* manual.

**STEP 1:** Start the NETGEN (or ELSGEN) procedure according to the instructions in the NetWare installation manual.

**STEP 2:** When the LAN Driver Options menu appears, select "Load and Select Item". The following prompt will appear:

```
Insert disk matching LAN_DRV_??? in any drive
```

Insert the G/Ethernet Drivers diskette (LAN\_DRV\_207) and press <Esc>.

**STEP 3:** When the Available LAN Drivers window appears, select "G/Ethernet AT Adapter by Gateway Communications".

**STEP 4:** Specify the adapter's configuration by selecting the "Configure Drivers/ Resources" option from the NetWare menu. From the "Available Resource Configurations" window select the IRQ and device I/O combination.

Proceed with the instructions in the NetWare installation manual to complete the process.

## Using the Hard Disk or Network Drive Methods

Use the following instructions in conjunction with those in the *SFT/Advanced NetWare Installation or ELS Level II Installation* manual.

### If NetWare Has Never Been Installed

**STEP 1:** Start the NETGEN (or ELSGEN) utility according to the instructions in the NetWare installation manual.

**STEP 2:** When the following message appears

Upload Additional Diskettes?

Highlight Yes and press <Enter>.

Insert the LAN\_DRV\_207 (G/Ethernet Drivers) diskette in drive A: and press <Esc>. The drivers will be copied from the LAN\_DRV\_207 diskette onto the hard drive.

**STEP 3:** When the LAN Driver Options menu appears, select "Load and Select Item".

**STEP 4:** When the Available LAN Drivers window appears, select "G/Ethernet AT Adapter by Gateway Communications".

**STEP 5:** Specify the adapter's configuration by selecting the "Configure Drivers/ Resources" option from the NetWare menu. From the "Available Resource Configurations" window select the IRQ and device I/O combination.

Proceed with the instructions in the NetWare installation manual to complete the process.

### If NetWare Has Previously Been Installed

**STEP 1:** *If the NetWare files have been installed in a subdirectory:*

Create a subdirectory within the NetWare directory for the G/Ethernet drivers. Type

`MD\netware\LAN_DRV_207 <Enter>`

where

*netware* is the name of the subdirectory the NetWare files and subdirectories are located.

Be sure to place a period before 207.

*If the NetWare files have been installed in the root directory:*

From the root directory, create a subdirectory for the drivers. Type

`MD\LAN_DRV_207 <Enter>`

Be sure to place a period before 207.

**STEP 2:** Copy the contents of the root directory from the G/Ethernet Drivers diskette into the LAN\_DRV\_207 subdirectory.

**STEP 3:** Start the NETGEN or ELSGEN utility according to the instructions in the NetWare installation manual.

**STEP 4:** When the LAN Driver Options menu appears, select "Load and Select Item".

**STEP 5:** When the Available LAN Drivers window appears, select "G/Ethernet AT Adapter by Gateway Communications".

**STEP 6:** Specify the adapter's configuration by selecting the "Configure Drivers/ Resources" option from the NetWare menu. From the "Available Resource Configurations" window select the IRQ and device I/O combination.

Proceed with the instructions in the NetWare installation manual to complete the process.

## INSTALLING EXTERNAL BRIDGE DRIVERS FOR NETWARE V2.11 AND V2.12

This section describes the procedure for installing G/Ethernet drivers for an external bridge. Use these instructions in conjunction with the *NetWare External Bridges Supplement*.

The driver and operating system pointer files are located in the root directory of the G/Ethernet Drivers diskette.

For this procedure, you will need a working copy of the G/Ethernet Drivers diskette and the NetWare BRGEN-1 diskette.

**STEP 1:** Make sure that there is enough space on the BRGEN-1 diskette for the drivers. Insert the BRGEN-1 diskette in drive A: and the G/Ethernet Drivers diskette in drive B:.

Run a directory of the BRGEN-1 diskette. If you have less than 700 bytes of available disk space, delete any unnecessary files to make room for the drivers. Do not erase any BRGEN-1 files.

**STEP 2:** Copy the operating system pointer file, GEATOS.LAN, from the root directory of the G/Ethernet Drivers diskette onto the BRGEN-1 diskette by typing

```
COPY B:GEATOS.LAN A: <Enter>
```

The remaining .OBJ files stay on the G/Ethernet Drivers diskette and will be used during the BRGEN procedure.

**STEP 3:** Start the BRGEN procedure according to the instructions in the *NetWare External Bridges Supplement*. When prompted, insert the LAN\_DRV\_207 (G/Ethernet Drivers) diskette and select "G/Ethernet AT Adapter by Gateway Communications" from the list of LAN adapter options.

**STEP 4:** Specify the adapter's configuration by selecting the "Configure Drivers/ Resources" option from the NetWare menu. From the "Available Resource Configurations" window select the IRQ and device I/O combination.

Proceed with the instructions in the *NetWare External Bridges Supplement* to complete the process.

## INSTALLING EXTERNAL BRIDGE DRIVERS FOR NETWARE V2.15

This section describes the procedure for installing G/Ethernet drivers for an external bridge. The driver is located in the root directory of the G/Ethernet Drivers diskette.

This section describes two methods of driver installation:

- Using the Standard Floppy Disk method
- Using the Hard Disk and Network Drive methods

For either of these procedures, you will need a working copy of the G/Ethernet Drivers diskette, plus the appropriate NetWare diskettes.

### Using the Standard Floppy Disk Method

Use the instructions in this section in conjunction with the *NetWare External Bridges Supplement*.

**STEP 1:** Start the BRGEN procedure according to the instructions in the NetWare bridges supplement.

**STEP 2:** When the LAN Driver Options menu appears, select "Load and Select Item". The following prompt will appear:

```
Insert disk matching LAN_DRV_??? in any drive
```

Insert the G/Ethernet Drivers diskette (LAN\_DRV\_207) and press <Esc>.

**STEP 3:** When the Available LAN Drivers window appears, select "G/Ethernet AT Adapter by Gateway Communications".

**STEP 4:** Specify the adapter's configuration by selecting the "Configure Drivers/ Resources" option from the NetWare menu. From the "Available Resource Configurations" window select the IRQ and device I/O combination.

Proceed with the instructions in the *NetWare External Bridges Supplement* to complete the process.

## Using the Hard Disk or Network Drive Methods

Use the instructions in this section in conjunction with the *NetWare External Bridges Supplement*.

**STEP 1:** Create a subdirectory within the BRGEN directory for the G/Ethernet drivers. Type

```
MD\BRGEN\LAN_DRV_.207 <Enter>
```

Be sure to place a period before 207.

**STEP 2:** Copy the contents of the root directory of the G/Ethernet Drivers diskette into the LAN\_DRV\_.207 subdirectory.

**STEP 3:** Start the BRGEN utility according to the instructions in the NetWare bridges supplement.

**STEP 4:** When the LAN Driver Options menu appears, select "Load and Select Item".

**STEP 5:** When the Available LAN Drivers window appears, select "G/Ethernet AT Adapter by Gateway Communications".

**STEP 6:** Specify the adapter's configuration by selecting the "Configure Drivers/ Resources" option from the NetWare menu. From the "Available Resource Configurations" window select the IRQ and device I/O combination.

Proceed with the instructions in the *NetWare External Bridges Supplement* to complete the process.

## INSTALLING WORKSTATION DRIVERS FOR 3+SHARE

This section describes the procedure for installing G/Ethernet drivers for a 3+Share workstation.

You will need a working copy of the G/Ethernet Drivers diskette and the 3+Share workstation boot diskette.

Before you can use the workstation boot diskette on a 3+Share LAN, the G/Ethernet workstation driver must be present on the 3+Share workstation boot diskette, and the CONFIG.SYS file must be modified.

The drivers for 3+Share are located in the 3COM subdirectory on the G/Ethernet Drivers diskette. The 3COM subdirectory contains the necessary drivers for several different G/Ethernet adapters. The workstation driver for the 16-bit AT adapter is called G3C\_AT.SYS.

Use the following method to install the G/Ethernet driver and modify the CONFIG.SYS file.

**STEP 1:** Make sure that there is enough space available on the diskette. Insert the 3+Share boot diskette in drive A: and the G/Ethernet Drivers diskette in drive B:.

Run a directory of the 3+Share boot diskette. If you have less than 1200 bytes of available disk space, delete any unnecessary files to make room for the driver. Do not erase any 3+Share files.

**STEP 2:** Copy the G/Ethernet workstation driver (G3C\_AT.SYS) into the 3DRIVERS directory on the 3+Share workstation boot diskette. The workstation driver is located in the 3COM subdirectory on the G/Ethernet Drivers diskette. Type

```
COPY B:\3COM\G3C_AT.SYS A: <Enter>
```

**STEP 3:** Use a text editor to modify the 3+Share boot diskette's CONFIG.SYS file. If you are using the default device I/O address and IRQ, change the device statement to:

```
DEVICE=\3DRIVERS\G3C_AT.SYS
```

**STEP 4:** If you are unable to use the default hardware configuration for the G/Ethernet adapter, add a valid device I/O address and IRQ number to the end of the DEVICE statement. Refer to Figure 2-1 for the available settings.

To change the device I/O and IRQ hardware settings, enter the device I/O address and the interrupt number after the G/Ethernet driver name. For example, to change the hardware configuration to device I/O address 00280 and IRQ 5, modify the DEVICE command to

```
DEVICE=\3DRIVERS\G3C_AT.SYS 280 5
```

**NOTE**

*You must also change the adapter's IRQ and device I/O settings to match the software configuration. Refer to the Section 2 for information on configuring the hardware.*

The driver installation process is now complete.

The diagnostic routines test the G/Ethernet 8-bit adapter for correct hardware and configured software settings, properly operating hardware, error-free memory, and proper cable connections. The diagnostic program was *not* designed as a true cable test. It will only detect a cable-type selection or terminator problem.

The diagnostics program, ETHERCHX.EXE, resides in the DIAG subdirectory on the G/Ethernet Drivers diskette.

Before running the diagnostics on a G/Ethernet 8-bit adapter, you need to know the cable type, device I/O address, IRQ number and Autoboot PROM address.

If you do not know these settings and the defaults were used, refer to Figure 2-1. Otherwise, power off the computer, remove the adapter, and check the settings.

**RUNNING THE DIAGNOSTIC PROGRAM**

Perform the following steps to run the diagnostics routine.

**STEP 1:** Before running the diagnostics program be sure that the network cable is terminated using a 50-ohm terminator on each end of the cable. If you prefer not to use a cable you may terminate both ends of the T-connector then attach the connector to the adapter. The network line must be inactive.

**NOTE**

*A thick cable type selection for an AUI connector will fail Loopback Mode 3 Test if a cable and terminator are not connected.*

**STEP 2:** Insert the working copy of the G/Ethernet Drivers diskette into drive A:. Change to the DIAG subdirectory by typing

**A:CD\DIAG <Enter>**

**STEP 3:** Run the diagnostics program by typing

**A:ETHERCHX <Enter>**

The Type of Adapter menu will display.

**STEP 4:** Press 2 then <Enter> to select the 16-bit AT adapter.

**STEP 5:** When the Device I/O Address screen displays, enter the number (1 through 8) that corresponds to the configuration of switches 1 through 4 of SW1 on the 16-bit adapter. Press <Enter> to continue.

**STEP 6:** When the Interrupt Request Line screen displays, enter the number (1 through 7) that corresponds to the configuration of jumper JP2 on the 16-bit adapter. Press <Enter> to continue.

**STEP 7:** When the Cable Type Selection Jumper screen displays, select 1 if JP4 is set for thin Ethernet cable or select 2 if JP4 is set for thick Ethernet cable. Press <Enter> to continue.

The diagnostic routines will perform a hardware test using the selections you entered. Following the hardware test, four additional tests are performed; memory, start/stop, regular, and selective.

When the diagnostic routines have completed and each test has passed, the following message will display and the program will exit to DOS:

Your G/Ethernet Adapter Has Passed The Diagnostic Program  
End of Test

## ERROR MESSAGES

The following information provides a description and explanation of the error messages that may occur.

**ERROR:** PLEASE VERIFY YOUR SELECTION OF I/O ADDRESS,  
YOU MUST REBOOT THE PC TO RUN THE DIAGNOSTIC AGAIN

**ACTION:** Verify that there is not a conflict between hardware and software settings, or that you did not enter the settings incorrectly into the diagnostic program.

**ERROR:** UNABLE TO CONTINUE TESTS  
YOU MAY HAVE A BAD BOARD

**ACTION:** A failure has occurred during the memory, stop/start, regular, and selective tests. You may have a defective adapter. Contact your dealer.

This section describes errors that commonly occur after installing the G/Ethernet adapter. Read the checklist first to make sure there is not something that you overlooked.

### CHECKLIST

Following is a list of causes that *commonly* contribute, or are the sole cause of problems:

- Are all of the cables, T-connectors, and terminators connected properly and firmly?
- Is each end of each cable segment terminated?
- Is the cable segment grounded properly?
- Does the impedance of the cable match that of the terminators?
- Are the cable length and number of workstations or other devices within the limits of the 802.3 specification?
- Are there any splices or cuts in the cable?
- Do the hardware and software configurations match?
- Is the electrical circuitry in your building adequate?
- Is the correct G/Ethernet driver installed?

### SYMPTOMS

This section lists symptoms of problems that you may encounter with G/Ethernet and suggests solutions.

#### File Server hangs:

Verify that you selected the correct driver. Select the G/Ethernet PC driver for the 8-bit WS or 8-bit PC adapter.

Verify that you do not have a conflict with another option card installed in the file server.

### Troubleshooting

If COM2 is installed, you cannot use the default interrupt (IRQ3).

#### File Server not Found:

Verify that the T-connector is 0.2-ohm maximum resistance.

Verify that the terminators are 50-ohm.

Verify that the cable jumper selection is set according to the cable type (thin or thick).

Verify that the cable segment is properly grounded and that each cable segment is grounded in one place only.

Verify that the cable is the same type of RG-58 cable used throughout the network.

Verify that the cable is within the limits of the specification.

#### Intermittent Failures:

Verify that you do not have an IRQ or I/O address conflict with another option card installed in the file server. Refer to Section 2, *Hardware Configuration*, for instructions on configuring the IRQ and I/O settings.



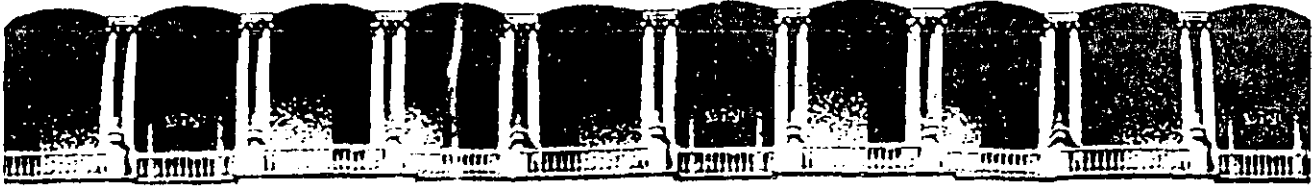

**FACULTAD DE INGENIERIA U.N.A.M.  
DIVISION DE EDUCACION CONTINUA**

**INSTALACION Y MANEJO DE REDES (LAN) CON**

**NETWARE DE NOVELL (PARTE III)**

**INSTALACION DEL SISTEMA OPERATIVO**

**NOVIEMBRE, 1992**



**INSTALACION DEL  
SISTEMA OPERATIVO**

# GENERACION "SHELL" E.T.

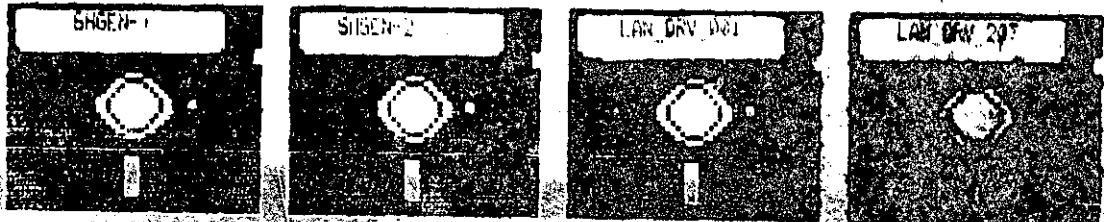

apuntes

# GENERATION "SHELL" E.T



Shell Generation V4.00

### SHGEN Run Options

- Standard (floppy disks)
- Hard Disk
- Network Drive

Drive: C

Type in the letter corresponding to the drive SHGEN can use.

apuntes

# GENERACTON "SHELL" E.T.



Shell Generation V4.00

Insert disk SHGEN-2 in any drive.  
<Press ESCAPE to Continue>

Uploading files from floppy disk.

apunttes

# GENERACTON "SHELL" E.T.



Shell Generation V4.00

Insert disk SHGEN-2 in any drive.  
(Press ESCAPE to Continue)

Uploading files from floppy disk.

apuntes

# GENERATION "SHELL" E.T.



Shell Generation V4.00

Insert disk LAN\_DRV\_001 in any drive.  
<Press ESCAPE to Continue>

Uploading files from floppy disk.

apuntes

# GENERATION "SHELL" E.T.



Shell Generation V4.00

Upload Additional Diskettes?

Yes  
No

Uploading files from floppy disk.

apuntes



# GENERACTON "SHELL" E.T.



Shell Generation V4.00

Insert diskette to upload in Drive A  
(Press ESCAPE to Continue)

Uploading files from floppy disk.

apuntes

# GENERACTON "SHELL" E.T.



Shell Generation V4.00

Shell Generation Options

Select Shell Configuration  
Exit SHGEN

Valid Shell Exists on SHGEN-2

Use the arrow keys to highlight an option, then press the SELECT key.

apuntes

# GENERATION "SHELL" E.T.



Shell Configuration V4.02

Sunday July 8, 1990 5:30 pm

Driver 1- "8/Ethernet PC by Gateway Communications, Inc., V2.A0"  
has the same type number as  
Driver 2- "8/Ethernet PC by Gateway Communications, Inc., V2.5"?

Replace Driver 1 with Driver 2?

- No
- Yes

apuntes

# GENERACION "SHELL" E.T.



Shell Configuration V4.02                      Sunday July 8, 1990 6:30 pm

- Available Options
- Select Resource Sets (optional)
  - Select LAN Driver
  - Configure Driver / Resources
  - Edit Resource List
  - Edit Resource Sets
  - Save Selections and Continue

Use the arrow keys to highlight an option, then press the SELECT key.

apuntes

# GENERACTON "SHELL" E.T.



Shell Configuration V4.02

Sunday July 8, 1990 6:19 pm

## Resources

- AST clock/calendar
- AT Auxiliary ROM
- Color Graphics Adapter
- COM1
- COM1 (No Interrupts)
- COM2
- COM2 (No Interrupts)
- Enhanced Graphics Adapter (No Interrupts)

SELECT (Enter) Edit highlighted item.    INSERT (Ins) Add new item.  
 DELETE (Del) Delete marked item(s).    MODIFY (F3) Change item name.  
 MARK (F5) Mark highlighted item.    UNMARK (F7) Unmark all items.  
 Press ESCAPE to save changes and return to the preceding screen.

apuntes

# GENERACTON "SHELL" E.T



Shell Configuration V4.02 Sunday July 8, 1990 6:20 pm

Resources

- AST clock/calendar
- AT Auxiliary ROM
- Color Graphics Adapter
- COM1
- COM1 (No Interrupts)
- COM2
- COM2 (No Interrupts)
- Enhanced Graphics Adapter (No Interrupts)

Resource Name

tarjeta de video VGA

Enter a name for the resource, then press the SELECT key.

apuntes

# GENERACTON "SHELL" E.T.



Shell Configuration V4.02                      Sunday July 8, 1990 6:21 pm

- Resources
- LPT1
  - LPT1 (No Interrupts)
  - LPT2
  - LPT2 (No Interrupts)
  - LPT3 (No Interrupts)
  - Monochrome Adapter
  - Novell 286B Floppy Controller
  - tarjeta de video VGA

SELECT (Enter) Edit highlighted item.    INSERT (Ins) Add new item.  
 DELETE (Del) Delete marked item(s).    MODIFY (F3) Change item name.  
 MARK (F5) Mark highlighted item.        UNMARK (F7) Unmark all items.  
 Press ESCAPE to save changes and return to the preceding screen.

apuntes

# GENERACTON "SHELL" E.T



Shell Configuration V4.92

Sunday July 8, 1990 6:22 pm

Resources

Resource Configurations

SELECT (Enter) Edit highlighted item.    INSERT (Ins) Add new item.  
 DELETE (Del) Delete marked item(s).    MODIFY (F3) Change item name.  
 MARK (F5) Mark highlighted item.    UNMARK (F7) Unmark all items.  
 Press ESCAPE to save changes and return to the preceding screen.

apuntes



# GENERACTON "SHELL" E.T.



Shell Configuration V4.02

Sunday July 8, 1990 6:24 pm

Resources

Resource Configurations

Resource Configuration Name

0: IRQ 6, M ADDRESS : 1F7H, I/O : 37F, DMA 1

Enter a name for the configuration, then press the SELECT key.

apuntes

# GENERACTON "SHELL" E.T.



Shell Configuration V4.02

Sunday July 8, 1990 6:25 pm

## Resources

### Resource Configurations

0: IRQ 6, M ADDRESS : 1F7H, I/O : 37F, DMA 1

SELECT (Enter) Edit highlighted item.    INSERT (Ins) Add new item.  
 DELETE (Del)    Delete marked item(s).    MODIFY (F3)    Change item name.  
 MARK (F5)    Mark highlighted item.    UNMARK (F7)    Unmark all items.  
 Press ESCAPE to save changes and return to the preceding screen.

apuntes

# GENERATION "SHELL" E.T



Shell Configuration V4.02

Sunday July 8, 1990 6:26 pm

| Configuration Information     |               | (Mode: Decimal)  |
|-------------------------------|---------------|------------------|
| Number of I/O Address Ranges: | 0             | Bus: Standard    |
| Starting Address #1:          |               | Range (bytes):   |
| Starting Address #2:          |               | Range (bytes):   |
| Number of Memory Addr         |               |                  |
| Starting Segment #1           | Bus Type      | ge (Paragraphs): |
| Starting Segment #2           |               | ge (Paragraphs): |
| Number of Interrupt L         | Either Type   |                  |
| Interrupt Line #1:            | Micro Channel | errupt Line #2:  |
| Number of DMA Lines:          | Standard      |                  |
| DMA Line #1:                  |               | Line #2:         |

1. Press the F2 key to switch between hex and decimal editing modes.
2. Highlight a field using the arrow keys, then press the SELECT key.
3. Edit the field using the arrow, DELETE, BACKSPACE, and SELECT keys.
4. Press ESCAPE to save configuration information.

apuntes

# GENERACTON "SHELL" E.T.



Shell Configuration V4.02

Sunday July 8, 1990 6:29 pm

| Configuration Information        |     | (Mode: Hex)            |
|----------------------------------|-----|------------------------|
| Number of I/O Address Ranges:    | 1   | Bus: Standard          |
| Starting Address #1:             | 37F | Range (bytes): 16      |
| Starting Address #2:             |     | Range (bytes):         |
| Number of Memory Address Ranges: | 1   |                        |
| Starting Segment #1:             | 1F7 | Range (Paragraphs): 16 |
| Starting Segment #2:             |     | Range (Paragraphs):    |
| Number of Interrupt Lines:       | 1   |                        |
| Interrupt Line #1:               | 6   | Interrupt Line #2:     |
| Number of DMA Lines:             | 1   |                        |
| DMA Line #1:                     | 2   | DMA Line #2:           |

1. Press the F2 key to switch between hex and decimal editing modes.
2. Highlight a field using the arrow keys, then press the SELECT key.
3. Edit the field using the arrow, DELETE, BACKSPACE, and SELECT keys.
4. Press ESCAPE to save configuration information.

apuntes

# GENERATION "SHELL" E.T.



Shell Configuration V4.02                      Sunday July 8, 1990 6:30 pm

| Available Options                                                                                                                                                |
|------------------------------------------------------------------------------------------------------------------------------------------------------------------|
| Select Resource Sets (optional)<br>Select LAN Driver<br>Configure Driver / Resources<br>Edit Resource List<br>Edit Resource Sets<br>Save Selections and Continue |

Use the arrow keys to highlight an option, then press the SELECT key.

apuntes

# GENERACTON "SHELL" E.T.



Shell Configuration V4.02

Sunday July 8, 1998 6:31 pm

## Resource Sets

AST Clock-Calendar Card  
 Color Graphics Adapter  
 COM1  
 COM1 (No Interrupts)  
 COM2  
 COM2 (No Interrupts)  
 Enhanced Graphics Adapter (No Interrupts)  
 Enhanced Graphics Adapter (Uses IRQ 2)

SELECT (Enter) Edit highlighted item.    INSERT (Ins) Add new item.  
 DELETE (Del) Delete marked item(s).    MODIFY (F3) Change item name.  
 MARK (F5) Mark highlighted item.    UNMARK (F7) Unmark all items.  
 Press ESCAPE to save changes and return to the preceding screen.

apuntes

# GENERATION "SHELL" E.T.



Shell Configuration V4.02

Sunday July 8, 1990 6:32 pm

### Resource Sets

- AST Clock-Calendar Card
- Color Graphics Adapter
- COM1
- COM1 (No Interrupts)
- COM2
- COM2 (No Interrupts)
- Enhanced Graphics Adapter (No Interrupts)
- Enhanced Graphics Adapter (Uses IRQ 2)

Resource Set Name: COMPUTADORA XT, STANDAR C. ICIMEX

Enter a name for the resource set, then press the SELECT key.

apuntes

# GENERATION "SHELL" E.T.



Shell Configuration V4.02

Sunday July 8, 1990 6:33 pm

## Resource Sets

COM1  
 COM1 (No Interrupts)  
 COM2  
 COM2 (No Interrupts)  
 COMPUTADORA XT, STANDAR C. ICIMEX  
 Enhanced Graphics Adapter (No Interrupts)  
 Enhanced Graphics Adapter (Uses IRQ 2)  
 Hercules Monochrome Adapter

SELECT (Enter) Edit highlighted item.    INSERT (Ins) Add new item.  
 DELETE (Del) Delete marked item(s).    MODIFY (F3) Change item name.  
 MARK (F5) Mark highlighted item.    UNMARK (F7) Unmark all items.  
 Press ESCAPE to save changes and return to the preceding screen.

apuntes



# GENERATION "SHELL" E.T



Shell Configuration V4.02

Sunday July 8, 1990 6:35 pm

Resource Sets

Selected Resources

INSERT (Ins) Add new itea.            MARK (F5) Mark highlighted itea.  
 DELETE (Del) Delete Marked itea(s). UNMARK (F7) Unmark all iteas.  
 Press ESCAPE to save changes and return to the preceding screen.

apuntes

# GENERACTON "SHELL" E.T.



Shell Configuration V4.02

Sunday July 8, 1990 6:38 pm

## Resource Sets

### Selected Resources

|Color Graphics Adapter  
 |COM1  
 |COM2  
 |LPT1  
 |Western Digital Floppy Controller

INSERT (Ins) Add new item. MARK (F5) Mark highlighted item.  
 DELETE (Del) Delete Marked item(s). UNMARK (F7) Unmark all items.  
 Press ESCAPE to save changes and return to the preceding screen.

apuntes

# GENERACTON "SHELL" E.T.



Shell Configuration V4.02

Sunday July 8, 1990 6:39 pm

### Available Options

- Select Resource Sets (optional)
- Select LAN Driver
- Configure Driver / Resources
- Edit Resource List
- Edit Resource Sets
- Save Selections and Continue

Use the arrow keys to highlight an option, then press the SELECT key.

apuntes

# GENERACTON "SHELL" E.T.



Shell Configuration V4.02

Sunday July 8, 1998 6:48 pm

## Selected Resource Sets

Se  
Se  
Co  
Ed  
Ed  
Sa

### Resource Set Options

Select Available Item  
Load and Select Item

Use the arrow keys to highlight an option, then press the SELECT key. Press ESCAPE to save selections and continue.

apuntes

# GENERATION "SHELL" E.T.



Shell Configuration V4.02

Sunday July 8, 1990 6:41 pm

### Selected Resource Sets

Se  
Se  
Co  
Ed  
Ed  
Sa

### Available Resource Sets

COM2  
COM2 (No Interrupts)  
COMPUTADORA XT, STANDAR C. ICIMEX  
Enhanced Graphics Adapter (No Interrupts)  
Enhanced Graphics Adapter (Uses IRQ 2)

Highlight a list entry, then press the SELECT key.

apuntes

# GENERATION "SHELL" E.T.



Shell Configuration V4.02

Sunday July 8, 1990 6:42 pm

| Selected Resource Sets |                                   |
|------------------------|-----------------------------------|
| Se                     | COMPUTADORA XT, STANDAR C. ICIMEX |
| Se                     |                                   |
| Co                     |                                   |
| Ed                     |                                   |
| Ed                     |                                   |
| Sa                     |                                   |

### Resource Set Options

- Select Available Item
- Load and Select Item
- Deselect Item

Use the arrow keys to highlight an option, then press the SELECT key. Press ESCAPE to save selections and continue.

apuntes

# GENERACTON "SHELL" E.T.



Shell Configuration V4.02                      Sunday July 8, 1990 6:42 pm

| Available Options                                                                                                                                                |
|------------------------------------------------------------------------------------------------------------------------------------------------------------------|
| Select Resource Sets (optional)<br>Select LAN Driver<br>Configure Driver / Resources<br>Edit Resource List<br>Edit Resource Sets<br>Save Selections and Continue |
| Use the arrow keys to highlight an option, then press the SELECT key.                                                                                            |

apuntes

# GENERACTON "SHELL" E.T.



Shell Configuration V4.02 Sunday July 8, 1990 6:43 pm

Selected LAN Driver

Se  
Se

- Configure Driver / Resources
- Edit Resource List
- Edit Resource Sets
- Save Selections and Continue

LAN Driver Options

- Select Available Item
- Load and Select Item

Use the arrow keys to highlight an option, then press the SELECT key. Press ESCAPE to save selections and continue.

apuntes



# GENERACTON "SHELL" E.T



Shell Configuration V4.02

Sunday July 8, 1990 6:44 pm

## Selected LAN Driver

Se

Se

Configure Driver / Resources

Ed

Ed

Sa

## Available LAN Drivers

- |G/Ethernet PC by Gateway Communications, Inc., V2.00
- IBM ASYNC (COM1/COM2) V1.00 (880808)
- IBM PCN II & Baseband V1.10 (880526)
- IBM Token Ring V2.41 (890505)
- NetWare Ethernet NE1000 V2.31EC (881024)

Highlight a list entry, then press the **SELECT** key.

apuntes

# GENERACTON "SHELL" E.T.



Shell Configuration V4.02

Sunday July 8, 1990 6:44 pm

### Selected LAN Driver

Se |G/Ethernet PC by Gateway Communications, Inc., V2.A0

- Se
- Configure Driver / Resources
- Edit Resource List
- Edit Resource Sets
- Save Selections and Continue

### LAN Driver Options

|Deselect Item

Use the arrow keys to highlight an option, then press the SELECT key. Press ESCAPE to save selections and continue.

apuntes

# GENERACTON "SHELL" E.T.



Shell Configuration V4.02

Sunday July 8, 1990 6:45 pm

### Available Options

- Select Resource Sets (optional)
- Select LAN Driver
- Configure Driver / Resources
- Edit Resource List
- Edit Resource Sets
- Save Selections and Continue

Use the arrow keys to highlight an option, then press the SELECT key.

apuntes

# GENERACTON "SHELL" E.T.



Shell Configuration V4.#2

Sunday July 8, 1990 6:45 pm

### Available Options

Select Resource Sets (optional)  
 Select LAN Driver  
 Configure Driver / Resources  
 Edit Resource List

Configure Driver / Resources

Choose LAN Configuration  
 Choose Resource Configuration

Use the arrow keys to highlight an option, then press the  
 SELECT key. Press ESCAPE to save selections and continue.

apuntes

# GENERATION "SHELL" E.T.



Shell Configuration V4.02

Sunday July 8, 1990 6:52 pm

## Unconfigured Driver

B/Ethernet PC by Gateway Communications, Inc., V2.A0

Highlight a list entry, then press the SELECT key.

apuntes

# GENERACTON "SHELL" E.T.



Shell Configuration V4.02

Sunday July 8, 1999 6:52 pm

## Unconfigured Driver

### Available LAN Driver Configurations

- 1: IRQ = 5, I/O Base = 288h, no DMA or ROM
- 3: IRQ = 5, I/O Base = 320h, no DMA or ROM
- 7: IRQ = 2, I/O Base = 2C0h, no DMA or ROM

Highlight a configuration, then press the SELECT key.

apuntes

# GENERACTON "SHELL" E.T.



Shell Configuration V4.02

Sunday July 8, 1990 6:53 pm

### Available Options

- | Select Resource Sets (optional)
- | Select LAN Driver
- | Configure Driver / Resources
- | Edit Resource List

### Configure Driver / Resources

- | Choose Resource Configuration
- | Release LAN Driver Configuration

Use the arrow keys to highlight an option, then press the SELECT key. Press ESCAPE to save selections and continue.

apuntes

# GENERATION "SHELL" E.T.



Shell Configuration V4.02

Sunday July 8, 1990 6:53 pm

## Resource Sets With Unconfigured Resources

#: COMPUTADORA XT, STANDAR C. ICINEX

Highlight a list entry, then press the SELECT key.

apuntes



# GENERACTON "SHELL" E.T.



Shell Configuration V4.92 Sunday July 8, 1990 6:54 pm

Resource Sets With Unconfigured Resources

Unconfigured Resources

3: LPT1

Highlight a resource, then press the SELECT key.

apuntes

# GENERACTON "SHELL" E.T.



Shell Configuration V4.02

Sunday July 8, 1998 6:54 pm

Resource Sets With Unconfigured Resources

Unconfigured Resources

Available Resource Configurations

- 0: IRQ=7, I/O Base=378h
- 1: IRQ=7, I/O Base=3BC h

Highlight a configuration, then press the SELECT key.

apuntes

# GENERATION "SHELL" E.T.



Shell Configuration V4.02

Sunday July 8, 1990 6:55 pm

### Available Options

- Select Resource Sets (optional)
- Select LAN Driver
- Configure Driver / Resources

Configure Driver / Resources

- Review Selected Configurations
- Release LAN Driver Configuration
- Release Resource Configuration

Use the arrow keys to highlight an option, then press the SELECT key. Press ESCAPE to save selections and continue.

apuntes



# GENERACTON "SHELL" E.T.



Shell Configuration V4.02                      Sunday July 8, 1990 6:56 pm

Selected Configurations

LAN Driver: G/Ethernet PC by Gateway Communications, Inc., V2.A0  
 Option 0: IRQ = 5, I/O Base = 280h, no DMA or ROM

Resource Set 1: COMPUTADORA XT, STANDAR C. ICIMEX  
 Resource 1: Color Graphics Adapter  
 Option 0: I/O 3D0h-3DFh; Mem 8800h-8BFFh

Resource 2: COM1  
 Option 0: Int 4; I/O 3F8h - 3FFh

Resource 3: COM2  
 Option 0: Int 3; I/O 2F8h - 2FFh

Resource 4: LPT1  
 Option 0: IRQ=7, I/O Base=378h

Use the arrow keys to scroll the display.  
Press ESCAPE to leave this window and continue.

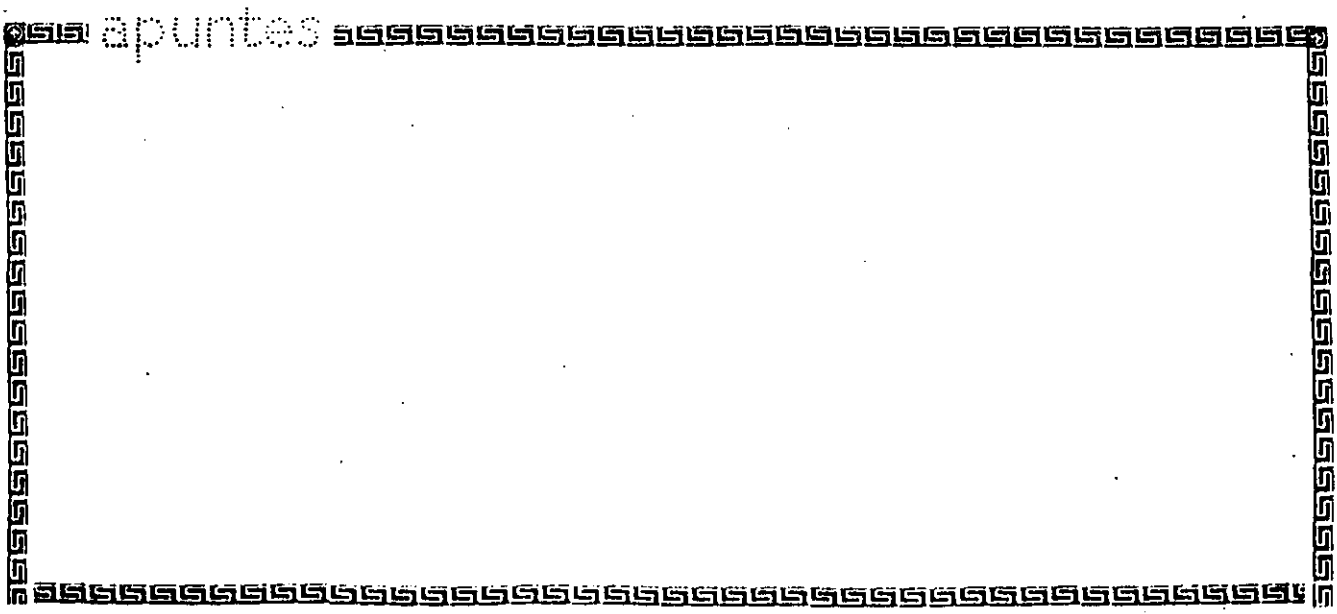

apuntes

# GENERACTON "SHELL" E.T.



Shell Configuration V4.02

Sunday July 8, 1990 6:56 pm

### Available Options

- Select Resource Sets (optional)
- Select LAN Driver
- Configure Driver / Resources
- Edit Resource List
- Edit Resource Sets
- Save Selections and Continue

Use the arrow keys to highlight an option, then press the SELECT key.

apuntes

# GENERACTON "SHELL" E.T



Shell Configuration V4.02                      Sunday July 8, 1990 6:57 pm

- Available Options
- | Select Resource Sets (optional)
  - | Select LAN Driver
  - | Configure Driver / Resources
  - | Edit Resource List
  - | Edit R
  - | Save S

Continue Shell Generation Using Selected Configurations?

| No

| Yes

Select "Yes" to save selected configurations and continue the shell generation process.

Select "No" to abandon the shell generation process.

Press ESCAPE to return to the shell configuration menu.

apuntes

# GENERACTON "SHELL" E.T.



Shell Configuration V4.02

Sunday July 8, 1990 6:58 pm

Save New Resource Set Definitions?

- | No
- | Yes

Select "Yes" to save new resource and resource set definitions.  
 Select "No" or press ESCAPE to discard any new resource and  
 resource set definitions.

ap:unbox

# GENERACTON "SHELL" E.T.



Shell Generation V4.06

- Shell Generation Options
- Select Shell Configuration
  - Configure Netware Shell
  - Exit SHGEN

Use the arrow keys to highlight an option, then press the SELECT key.

apuntes



# GENERATION "SHELL" E.T.



Configuring SHGEN-2:IPX.

Shell Generation V4.00

Shell Generation Options

Select Shell Configuration  
Exit SHGEN

Valid Shell Exists on SHGEN-2

Exit SHGEN

Yes  
No

Use the arrow keys to highlight an option, then press the SELECT key.

apuntes

# GENERATION "SHELL" E.T



Shell Generation V4.00

Shell Generation Options  
Select Shell Configuration  
Exit SHGEN

Use the arrow keys to highlight an option, then press the SELECT key.

apuntes





# NetWare Workstation Configuration Worksheet

FOR USE WITH ELS NETWARE LEVEL II (v2.12)

CONNECTED TO FILE SERVER \_\_\_\_\_ INSTALLER \_\_\_\_\_

SYSTEM SUPERVISOR \_\_\_\_\_

## WORKSTATION HARDWARE INFORMATION

- IBM PC
- IBM PC XT
- IBM PC AT
- IBM Personal System/2 Model \_\_\_\_\_
- IBM PC Compatible \_\_\_\_\_
- IBM XT Compatible \_\_\_\_\_
- IBM AT Compatible \_\_\_\_\_
- Other \_\_\_\_\_

MEMORY: Base \_\_\_\_\_ Extended \_\_\_\_\_ Total \_\_\_\_\_

FLOPPY DRIVE A:  5.25  3.5  Single-sided  Double-sided  High Capacity \_\_\_\_\_ KB

FLOPPY DRIVE B:  5.25  3.5  Single-sided  Double-sided  High Capacity \_\_\_\_\_ KB

INTERNAL HARD DISK: \_\_\_\_\_

| Name/Description                                            | Option No. | Int. Line (IRQ) | I/O Base Address | DMA Line | RAM/ROM Addresses | Notes |
|-------------------------------------------------------------|------------|-----------------|------------------|----------|-------------------|-------|
| <input type="checkbox"/> LAN INTERFACE BOARD DRIVER (LAN A) |            |                 |                  |          |                   |       |
| <input type="checkbox"/> RESOURCE SETS AND RESOURCES        |            |                 |                  |          |                   |       |
| Set                                                         | Res        |                 |                  |          |                   |       |
|                                                             |            |                 |                  |          |                   |       |
|                                                             |            |                 |                  |          |                   |       |
|                                                             |            |                 |                  |          |                   |       |
|                                                             |            |                 |                  |          |                   |       |
|                                                             |            |                 |                  |          |                   |       |
|                                                             |            |                 |                  |          |                   |       |
|                                                             |            |                 |                  |          |                   |       |
|                                                             |            |                 |                  |          |                   |       |
|                                                             |            |                 |                  |          |                   |       |
|                                                             |            |                 |                  |          |                   |       |
|                                                             |            |                 |                  |          |                   |       |
|                                                             |            |                 |                  |          |                   |       |
|                                                             |            |                 |                  |          |                   |       |
|                                                             |            |                 |                  |          |                   |       |
|                                                             |            |                 |                  |          |                   |       |
|                                                             |            |                 |                  |          |                   |       |
|                                                             |            |                 |                  |          |                   |       |
|                                                             |            |                 |                  |          |                   |       |
|                                                             |            |                 |                  |          |                   |       |
|                                                             |            |                 |                  |          |                   |       |

## BOOT INFORMATION

- Boot from Floppy Disk
- Boot by  $\longrightarrow$  Remote Reset

DOS Version \_\_\_\_\_

FILES COPIED TO MASTER SHELL DISKETTE

- IPX.COM
- NET3.COM
- NETBIOS.EXE
- 'NT2F.COM
- OTHERS \_\_\_\_\_

**Additional Information  
for Remote Boot Workstations Only**

Remote Reset Enabled  Yes  No

Remote Reset PROM(s) \_\_\_\_\_  
Installed on LAN Board \_\_\_\_\_

LAN Board Set to Configuration Option 0

Network Address \_\_\_\_\_

Station (Node) Hex \_\_\_\_\_  
Address Decimal \_\_\_\_\_

Remote Boot File Name \_\_\_\_\_

# NetWare File Server LAN Worksheet

FOR USE WITH ELS NETWARE LEVEL II (v2.12)

FILE SERVER NAME \_\_\_\_\_ INSTALLER \_\_\_\_\_  
 LAN INTERFACE BOARD \_\_\_\_\_ SYSTEM SUPERVISOR \_\_\_\_\_  
 NETWORK ADDRESS \_\_\_\_\_

WORKSTATIONS CONNECTED (LAN A) (For Remote Reset Only)

| Workstation ID | Type of Computer | DOS Version | Type of LAN Interface Board | Station (Node) Decimal | Address Hex | Remote Reset Boot DOS Image File |
|----------------|------------------|-------------|-----------------------------|------------------------|-------------|----------------------------------|
|                |                  |             |                             |                        |             |                                  |
|                |                  |             |                             |                        |             |                                  |
|                |                  |             |                             |                        |             |                                  |
|                |                  |             |                             |                        |             |                                  |
|                |                  |             |                             |                        |             |                                  |
|                |                  |             |                             |                        |             |                                  |
|                |                  |             |                             |                        |             |                                  |
|                |                  |             |                             |                        |             |                                  |

| NETWORKING HARDWARE         | Description | Vendor |
|-----------------------------|-------------|--------|
| Main Network Cable          |             |        |
| Drop Cables (if applicable) |             |        |
| Other Types of Cable Used   |             |        |
|                             |             |        |
| Connectors                  |             |        |
|                             |             |        |
| Other Hardware Used         |             |        |
|                             |             |        |
|                             |             |        |
|                             |             |        |
|                             |             |        |

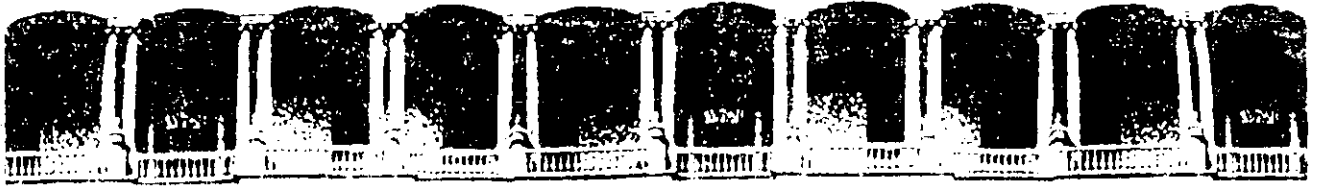

**FACULTAD DE INGENIERIA U.N.A.M.  
DIVISION DE EDUCACION CONTINUA**

**INSTALACION Y MANEJO DE REDES (LAN) CON  
NETWARE DE NOVELL (PARTE III)**

**GENERACION S.O. SERVER**

**NOVIEMBRE, 1992**

# GENERATION 5.0. SERVER

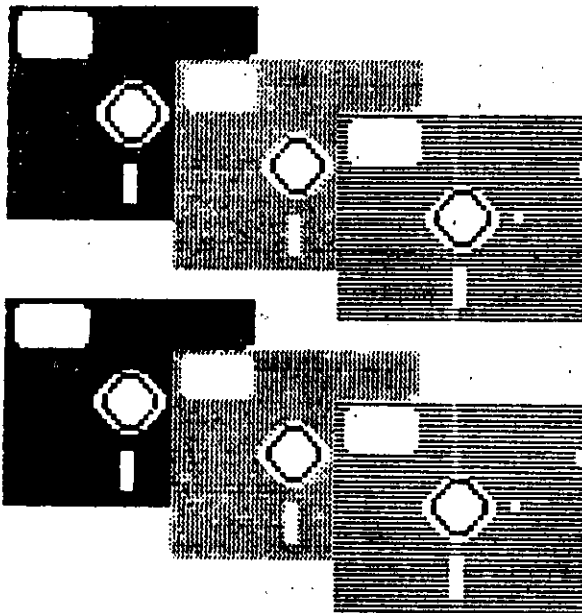

NETGEN  
SUPPORT  
AUXGEN  
GENDATA  
DSK\_DRV\_#01  
LAN\_DRV\_#01  
UTILOBJ-1  
UTILOBJ-2  
ANDOBJ  
ADOBJ  
OSOBJ  
OSEXE-1  
OSEXE-2  
UTILEXE-1  
UTILEXE-2  
DSK\_DRV\_209  
LAN\_DRV\_207

apuntes



# GENERATION 5.0. SERVER



A:\>dir

Volume in drive A is NETGEN  
Directory of A:\

|          |     |           |                  |        |
|----------|-----|-----------|------------------|--------|
| NETGEN   | EXE | 37601     | 8-18-88          | 9:53a  |
| VOLUMES  | DAT | 88        | 1-11-88          | 9:42a  |
| PRUN     | OVL | 2400      | 7-13-89          | 9:30a  |
| NINSTALL | EXE | 142739    | 1-25-89          | 3:57p  |
| UTILS    | DAT | 131       | 8-25-87          | 4:02p  |
| CMPSRUN  | OVL | 2400      | 7-26-89          | 10:26p |
| IBMSRUN  | OVL | 2400      | 7-13-89          | 9:30a  |
| INSTOVL  | EXE | 135514    | 5-04-92          | 10:00p |
|          |     | 8 File(s) | 33792 bytes free |        |

A:\>netgen/?

Usage: netgen [-n][c|d|s]

Where n = New System Generation  
c = Custom Configuration  
d = Default Configuration  
s = Standard Drive usage

A:\>netgen -n

Insert disk SUPPORT in any drive.

apuntes



# GENERACTON S.O. SERVER



NetWare Generation And Installation V4.08

- System Configuration Level
- | Default Configuration
  - | Custom Configuration \*

Use the arrow keys to highlight an option, then press the SELECT key.

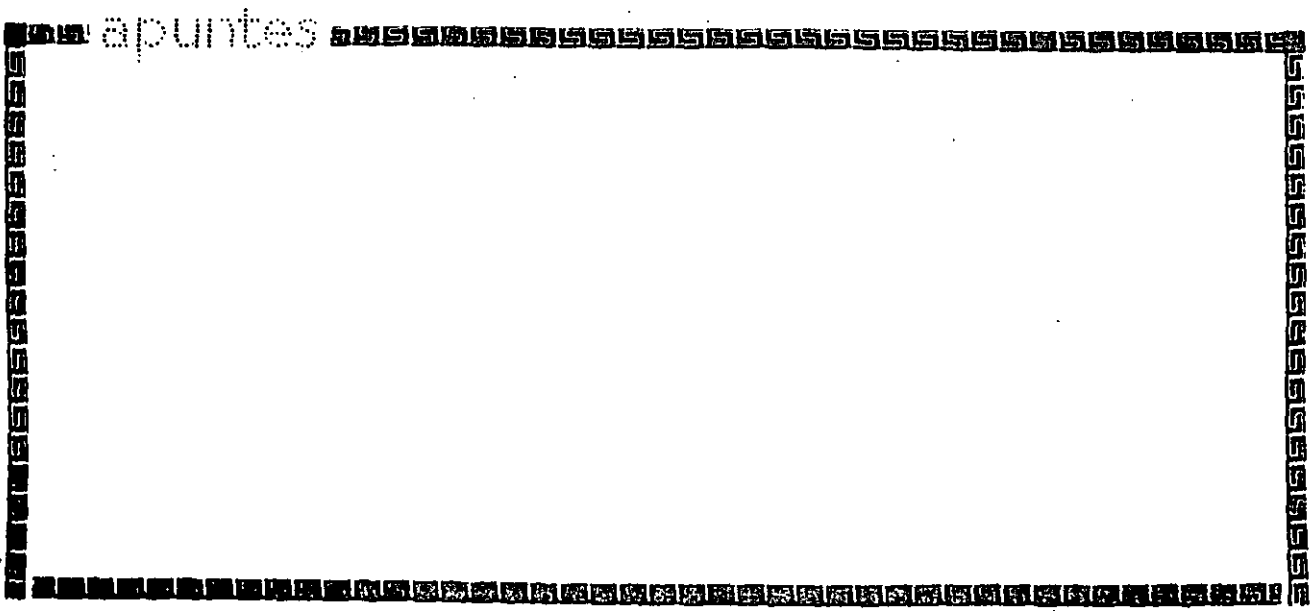
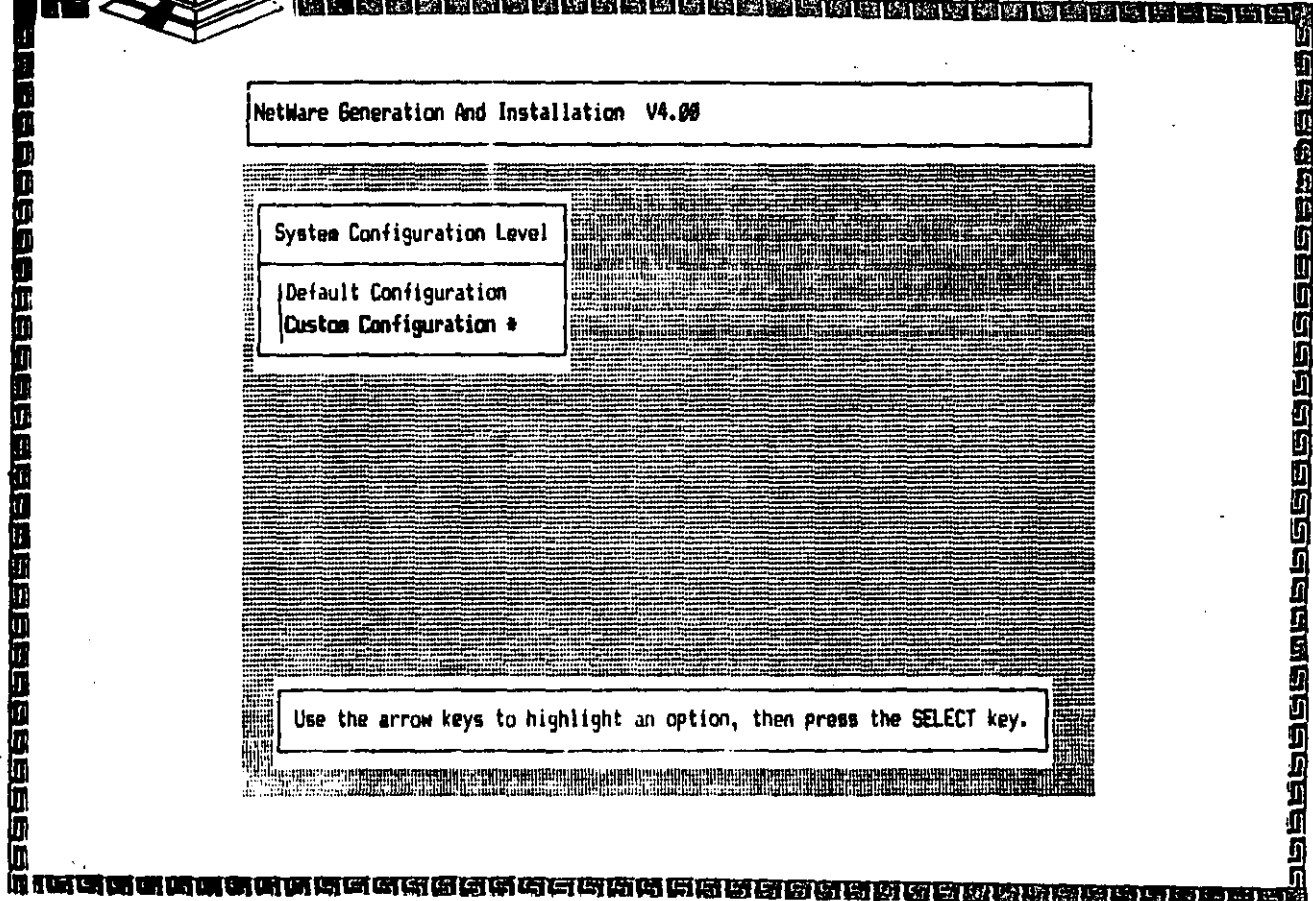

apuntes

# GENERATION S.O. SERVER



NetWare Generation And Installation V4.00

- NETGEN Run Options**
- Standard (floppy disks)
  - RAM Disk
  - Hard Disk
  - Network Drive

Drive: C

Type in the letter corresponding to the drive NETGEN can use.

apuntas

# GENERATION S.O. SERVER



NetWare Generation And Installation V4.00

Insert disk GENDATA in any drive.  
(Press ESCAPE to Continue)

Uploading files from floppy disk.

apuntes

# GENERACTON 5.0. SERVER



NetWare Generation And Installation V4.00

Upload Additional Diskettes?

- Yes +
- No

Uploading files from floppy disk.

apuntes

# GENERACTON S.O. SERVER



NetWare Generation And Installation V4.00

Insert diskette to upload in Drive A  
(Press ESCAPE to Continue)

Uploading files from floppy disk.

apuntes

# GENERATION S.O. SERVER



NetWare Generation And Installation V4.00

- Network Generation Options
- Select Network Configuration
  - Link/Configure NetWare Operating System
  - Configure NetWare Operating System
  - Link/Configure File Server Utilities
  - Exit NETGEN

Use the arrow keys to highlight an option, then press the SELECT key.

apuntes

# GENERATION S.O. SERVER



NetWare Generation And Installation V4.00

- Network Generation Options
- Select Network Configuration \*
  - Link/Configure NetWare Operating System
  - Configure NetWare Operating System
  - Link/Configure File Server Utilities
  - Exit NETGEN

Use the arrow keys to highlight an option, then press the SELECT key.

apuntes



# GENERACTON S.O. SERVER



Network Configuration V4.02

Wednesday July 11, 1990 12:53 pm

### Available Options

- | Set Operating System Options
- | Select Resource Sets
- | Select LAN Drivers
- | Select Disk Drivers
- Select "Other" Drivers
- | Configure Drivers / Resources
- | Edit Resource List
- | Edit Resource Sets
- | Save Selections and Continue

### Set Operating System Options

- | Advanced NetWare 286 / Dedicated
- | Advanced NetWare 286 / Nondedicated

Highlight an option, then press the SELECT key.

apuntes

# GENERATION 5.0. SERVER



Network Configuration V4.02

Wednesday July 11, 1990 12:53 pm

### Available Options

- Set Operating System Options
- Select Resource Sets
- Select LAN Drivers
- Select Disk Drivers
- Select "Other" Drivers
- Configure Drivers / Resources
- Edit Resource List
- Edit Resource Sets \*
- Save Selections and Continue

Use the arrow keys to highlight an option, then press the SELECT key.

apuntes

# GENERATION S.O. SERVER



Network Configuration V4.02

Wednesday July 11, 1990 12:56 pm

## Resource Sets

- COM6 (Micro Channel Only)
- COM7 (Micro Channel Only)
- COM8 (Micro Channel Only)
- PS/2 Math Coprocessor
- IBM PS/2 Model 70 File Server
- Novell 386A or 386AE File Server
- IBM PS/2 Model 50 or 50Z File Server
- ISA or AT Compatible File Server

SELECT (Enter) Edit highlighted item.    INSERT (Ins) Add new item.  
 DELETE (Del) Delete marked item(s).    MODIFY (F3) Change item name.  
 MARK (F5) Mark highlighted item.    UNMARK (F7) Unmark all items.  
 Press ESCAPE to save changes and return to the preceding screen.

apuntes

# GENERACTON S.O. SERVER



Network Configuration V4.02

Wednesday July 11, 1998 12:59 pm

## Available Options

- Set Operating System Options
- Select Resource Sets
- Select LAN Drivers \*
- Select Disk Drivers
- Select "Other" Drivers
- Configure Drivers / Resources
- Edit Resource List
- Edit Resource Sets
- Save Selections and Continue

Use the arrow keys to highlight an option, then press the SELECT key.

apuntes

# GENERACTON S.O. SERVER



Network Configuration V4.02

Wednesday July 11, 1990 12:59 pm

### Selected LAN Drivers

- Se
- Se
- Se
- Se
- Se
- Se
- Co
- Ed
- Ed
- Se

<INS>

### Available LAN Drivers

ACCTON ACC-10 Ethernet-8M Netware 2.15 Drive V2.00-R01 (03-21-19  
 8/Ethernet AT by Gateway Communications, Inc., V2.00 \*  
 8/Ethernet EC PC by Gateway Communications, Inc., V2.1

Highlight a list entry, then press the SELECT key.

apuntes

# GENERATION 5.0. SERVER



Network Configuration V4.02

Wednesday July 11, 1996 1:00 pm

### Selected LAN Drivers

Se A: 6/Ethernet AT by Gateway Communications, Inc., V2.00

Se  
Se  
Se  
Se  
Se

Configure Drivers / Resources |

Edit Resource List

Edit Resource Sets

Save Selections and Con

### LAN Driver Options

Select Loaded Item \*  
Load and Select Item  
Deselect an Item

Use the arrow keys to highlight an option, then press the SELECT (Enter) key. Press ESCAPE to save selections and continue.

apunttes

# GENERATION 5.0. SERVER



Network Configuration V4.02      Wednesday July 11, 1990 1:01 pm

| Selected LAN Drivers |                                                         |
|----------------------|---------------------------------------------------------|
| Se                   | A: G/Ethernet AT by Gateway Communications, Inc., V2.A0 |
| Se                   |                                                         |
| Se                   |                                                         |
| Se                   |                                                         |
| Se                   |                                                         |

| Available LAN Drivers |                                                        |
|-----------------------|--------------------------------------------------------|
| Co                    | G/Ethernet AT by Gateway Communications, Inc., V2.A0   |
| Ed                    | G/Ethernet EC PC by Gateway Communications, Inc., V2.1 |
| Ed                    | IBM ASYNC (COM1/COM2) V1.00 (880808) *                 |
| Sa                    | IBM PCN II & Baseband (Alternate) V1.00 (881021)       |
|                       | IBM PCN II & Baseband (Primary) V1.00 (881021)         |

Highlight a list entry, then press the SELECT key.

apuntes

# GENERATION S.O. SERVER



Network Configuration V4.02

Wednesday July 11, 1990 1:00 pm

### Selected LAN Drivers

|    |                                                         |
|----|---------------------------------------------------------|
| Se | A: 6/Ethernet AT by Gateway Communications, Inc., V2.A0 |
| Se |                                                         |
| Se |                                                         |
| Se |                                                         |
| Se |                                                         |

Configure Drivers / Resources |  
 Edit Resource List  
 Edit Resource Sets  
 Save Selections and Con

### LAN Driver Options

Select Loaded Item \*  
 Load and Select Item  
 Deselect an Item

Use the arrow keys to highlight an option, then press the SELECT (Enter) key. Press ESCAPE to save selections and continue.

apuntes



# GENERATION 5.0. SERVER



Network Configuration V4.02      Wednesday July 11, 1990 1:01 pm

| Selected LAN Drivers |                                                          |
|----------------------|----------------------------------------------------------|
| Se                   | IA: G/Ethernet AT by Gateway Communications, Inc., V2.A0 |
| Se                   |                                                          |
| Se                   |                                                          |
| Se                   |                                                          |
| Se                   |                                                          |

| Available LAN Drivers |                                                        |
|-----------------------|--------------------------------------------------------|
| G                     | G/Ethernet AT by Gateway Communications, Inc., V2.A0   |
| G                     | G/Ethernet EC PC by Gateway Communications, Inc., V2.1 |
| I                     | IBM ASYNC (COM1/COM2) V1.00 (880800) *                 |
| I                     | IBM PCN II & Baseband (Alternate) V1.00 (881021)       |
| I                     | IBM PCN II & Baseband (Primary) V1.00 (881021)         |

Highlight a list entry, then press the SELECT key.

apunttes

# GENERACTON S.O. SERVER



Network Configuration V4.02

Wednesday July 11, 1990 1:03 pm

### Selected LAN Drivers

- Se A: E/Ethernet AT by Gateway Communications, Inc., V2.A0
- Se B: IBM ASYNC (COM1/COM2) V1.00 (880800)
- Se C: IBM Token Ring V2.21 (880817)
- Se
- Se

Configure Drivers/ Resources

Edit Resource List

Edit Resource Sets

Save Selections and Con

### LAN Driver Options

- Select Loaded Item
- Load and Select Item
- Deselect an Item

Use the arrow keys to highlight an option, then press the SELECT (Enter) key. Press ESCAPE to save selections and continue.

apunttes

# GENERATION 5.0. SERVER



Network Configuration V4.02

Wednesday July 11, 1990 11:04 pm

### Available Options

- Set Operating System Options
- Select Resource Sets

- Select Disk Drivers \*
- Select "Other" Drivers
- Configure Drivers / Resources
- Edit Resource List
- Edit Resource Sets
- Save Selections and Continue

apuntes

# GENERATION 5.0. SERVER



Network Configuration V4.02      Wednesday July 11, 1990 1:09 pm

Selected Disk Drivers

|      |
|------|
| Se 0 |
| Se 1 |
| Se 2 |
| Se 3 |
| Se 4 |
| Co   |

Enter a channel number, then press the SELECT key.

apuntes

# GENERATION 5.0. SERVER



Network Configuration V4.02

Wednesday July 11, 1990 1:21 pm

### Selected Disk Drivers

- Se 0
- Se 1
- Se 2
- Se 3
- Se 4
- Co
- Ed
- Ed
- Se

### Select Disk Driver Type

Adaptec AHA-154x/1640 Host Adapter ver2.1  
 IBM PS/2 Model 30 286 MFM disk controller V1.01 (881028)  
 Industry Standard ISA or AT Comp. Disk Cont. V2.01 (890810) \*

Highlight a list entry, then press the SELECT key.

apuntes

# GENERATION S.O. SERVER



Network Configuration V4.02

Wednesday July 11, 1998 11:26 pm

## Selected Disk Drivers

|      |                                                             |
|------|-------------------------------------------------------------|
| Se 0 | Industry Standard ISA or AT Comp. Disk Cont. V2.01 (090810) |
| Se 1 |                                                             |
| Se 2 |                                                             |
| Se 3 |                                                             |
| Se 4 |                                                             |
| Co   |                                                             |

Edit Resource List  
 Edit Resource Sets  
 Save Selections and Con

### Disk Driver Options

Select Loaded Item  
 Load and Select Item  
 Deselect an Item

Use the arrow keys to highlight an option, then press the SELECT (Enter) key. Press ESCAPE to save selections and continue.

apuntes

# GENERATION 5.0. SERVER



Network Configuration V4.02

Wednesday July 11, 1996 1:38 pm

## Available Options

- Set Operating System Options
- Select Resource Sets
- Select LAN Drivers
- Select Disk Drivers
- Select "Other" Drivers
- Configure Drivers /Resources
- Edit Resource List
- Edit Resource Sets
- Save Selections and Continue

Use the arrow keys to highlight an option, then press the SELECT key.

# GENERACTON S.O. SERVER



Network Configuration V4.02      Wednesday July 11, 1990 1:39 pm

### Available Options

- | Set Operating System Options
- | Select Resource Sets
- | Select LAN Drivers

### Configure Drivers / Resources

- | Choose LAN Configuration
- | Enter Server Information
- | Release Disk Drive Configuration

Use the arrow keys to highlight an option, then press the SELECT (Enter) key. Press ESCAPE to save selections and continue.

apuntes



# GENERATION 5.0. SERVER



Network Configuration V4.02

Wednesday July 11, 1990 1:40 pm

## Unconfigured LAN Drivers

- A: G/Ethernet AT by Gateway Communications, Inc., V2.00 \*
- B: IBM ASYNC (COM1/COM2) V1.00 (888888)
- C: IBM Token Ring V2.21 (888817)

Highlight a list entry, then press the SELECT key.

apuntes

# GENERATION 5.0. SERVER



Network Configuration V4.02      Wednesday July 11, 1990 1:40 pm

### Unconfigured LAN Drivers

#### Available LAN Configurations

- 0: IRQ = 3, I/O Base = 2A0h, no DMA or ROM
- 1: IRQ = 4, I/O Base = 280h, no DMA or ROM
- 2: IRQ = 5, I/O Base = 2E0h, no DMA or ROM
- 3: IRQ = 2, I/O Base = 320h, no DMA or ROM
- 4: IRQ = 10, I/O Base = 360h, no DMA or ROM
- 5: IRQ = 11, I/O Base = 380h, no DMA or ROM
- 6: IRQ = 12, I/O Base = 2C0h, no DMA or ROM
- 7: IRQ = 15, I/O Base = 340h, no DMA or ROM

Highlight a configuration, then press the SELECT key.

apuntes

# GENERACTON S.O. SERVER



Network Configuration V4.02

Wednesday July 11, 1998 1:42 pm

### Available Options

- | Set Operating System Options
- | Select Resource Sets
- | Select LAN Drivers

### Configure Drivers / Resources

- | Choose LAN Configuration \*
- | Enter Server Information
- | Release LAN Configuration
- | Release Disk Drive Configuration

Use the arrow keys to highlight an option, then press the SELECT (Enter) key. Press ESCAPE to save selections and continue.

apuntes

# GENERATION 5.0. SERVER



Network Configuration V4.02

Wednesday July 11, 1990 1:42 pm

## Unconfigured LAN Drivers

C: IBM Token Ring V2.21 (880017)

Release Disk Drive Configuration

Highlight a list entry, then press the SELECT key.

apuntes

# GENERATION S.O. SERVER



Network Configuration V4.02

Wednesday July 11, 1998 1:43 pm

## Unconfigured LAN Drivers

### Available LAN Configurations

- 0: Token Ring Primary Adapter, IRQ = 2, IO = A20h, Mem = CC00h & D000h
- 1: Token Ring Alternate Adapter, IRQ = 3, IO = A24h, Mem = CE00h & D400h
- 2: Token Ring Alternate Adapter, IRQ = 7, IO = A24h, Mem = C400h & C000h
- 5: Token Ring Primary Adapter, IRQ = 3, IO = A20h, Mem = CC00h & D000h
- 6: Token Ring Primary Adapter, IRQ = 3, IO = A20h, Mem = CE00h & D400h
- 7: Token Ring Primary Adapter, IRQ = 7, IO = A20h, Mem = C800h & CC00h
- 8: Token Ring Primary Adapter, IRQ = 2, IO = A20h, Mem = C800h & CC00h
- 9: Token Ring Alternate Adapter, IRQ = 7, IO = A24h, Mem = D200h & DC00h

Highlight a configuration, then press the SELECT key.

apuntes

# GENERATION 5.0. SERVER



Network Configuration V4.02

Wednesday July 11, 1990 11:45 pm

### Available Options

- Set Operating System Options
- Select Resource Sets
- Select LAN Drivers

### Configure Drivers / Resources

- Enter Server Information \*
- Release LAN Configuration
- Release Disk Drive Configuration

Use the arrow keys to highlight an option, then press the SELECT (Enter) key. Press ESCAPE to save selections and continue.

apuntes

# GENERATION S.O. SERVER



Network Configuration V4.02

Wednesday July 11, 1990 1:47 pm

## File Server Information

|    |                                                         |
|----|---------------------------------------------------------|
| Se | A: G/Ethernet AT by Gateway Communications, Inc., V2.A0 |
| Se | Network Address: 00000001                               |
| Se | B: IBM ASYNC (COM1/COM2) V1.00 (888888)                 |
|    | Network Address: 00000002                               |
| Co | C: IBM Token Ring V2.21 (888817)                        |
|    | Network Address: 00000003                               |
| En | Communication Buffers: 40                               |

Release Disk Drive Configuration

Use the arrow keys to highlight the desired field, then type in the desired data. Press the ESCAPE key to save selections and continue.

apuntes

# GENERATION S.O. SERVER



Network Configuration V4.02      Wednesday July 11, 1990 1:48 pm

- Available Options
- Set Operating System Options
  - Select Resource Sets
  - Select LAN Drivers
- Configure Drivers / Resources
- Choose Disk Driver Configuration
  - Enter Server Information
  - Release LAN Configuration

Use the arrow keys to highlight an option, then press the SELECT (Enter) key. Press ESCAPE to save selections and continue.

apuntes



# GENERATION S.O. SERVER



Network Configuration V4.02

Wednesday July 11, 1999 1:49 pm

## Unconfigured Disk Drivers

0: Industry Standard ISA or AT Comp. Disk Cont. V2.01 (090810)

Highlight a list entry, then press the SELECT key.

apuntes

# GENERATION 50. SERVER



Network Configuration V4.02      Wednesday July 11, 1990 1:49 pm

### Unconfigured Disk Drivers

#### Available Disk Configurations

|    |         |           |            |          |         |
|----|---------|-----------|------------|----------|---------|
| 0: | ISADISK | PRIMARY   | Verify=ON  | I/O=1F0h | IRQ=14* |
| 1: | ISADISK | PRIMARY   | Verify=OFF | I/O=1F0h | IRQ=14  |
| 2: | ISADISK | SECONDARY | Verify=ON  | I/O=170h | IRQ=11  |
| 3: | ISADISK | SECONDARY | Verify=ON  | I/O=170h | IRQ=12  |
| 4: | ISADISK | SECONDARY | Verify=ON  | I/O=170h | IRQ=14  |
| 5: | ISADISK | SECONDARY | Verify=ON  | I/O=170h | IRQ=15  |
| 6: | ISADISK | SECONDARY | Verify=OFF | I/O=170h | IRQ=11  |
| 7: | ISADISK | SECONDARY | Verify=OFF | I/O=170h | IRQ=12  |

Highlight a configuration, then press the SELECT key.

apunttes

# GENERACTON S.D. SERVER



Network Configuration V4.#2

Wednesday July 11, 1990 1:50 pm

### Available Options

- Set Operating System Options
- Select Resource Sets
- Select LAN Drivers

### Configure Drivers / Resources

- Review Selected Configurations
- Enter Server Information
- Release LAN Configuration
- Release Disk Drive Configuration

Use the arrow keys to highlight an option, then press the SELECT

apuntes

# GENERATION S.O. SERVER



## Selected Configurations

LAN A: G/Ethernet AT by Gateway Communications, Inc., V2.A0  
 Option 2: IRQ = 5, I/O Base = 2E0h, no DMA or ROM  
 Network Address: 00000001

LAN B: IBM ASYNC (COM1/COM2) V1.00 (880000)  
 Option 0: COM1: IRQ = 4, IO Address = 3FBh, No DMA, No RAM, No ROM  
 Network Address: 00000002

LAN C: IBM Token Ring V2.21 (880017)  
 Option 0: Token Ring Primary Adapter, IRQ = 2, IO = A20h, Mem =  
 CC00h & D000h  
 Network Address: 00000003  
 Communication Buffers: 40

Disk Chan. 0: Industry Standard ISA or AT Comp. Disk Cont. V2.01 (890010)  
 Option 0: ISADISK PRIMARY Verify=ON I/O=1F0h  
 IRQ=14

Resource Set 1: ISA or AT Compatible File Server  
 Resource 1: AT Auxiliary ROM  
 Option 0: Mem E000h-EFFFh  
 Resource 2: Western Digital Floppy Controller  
 Option 0: IRQ=6, I/O Base=3F0h, DMA=2

apuntes

# GENERATION S.O. SERVER



Network Configuration V4.02

Wednesday July 11, 1990 1:55 pm

### Available Options

- | Set Operating System Options
- | Select Resource Sets
- | Select LAN Drivers
- | Select Disk Drivers
- | Select "Other" Drivers
- | Configure Drivers / Resources
- | Edit Resource List
- | Edit Resource Sets
- | Save Selections and Continue\*

Continue Network Generation Using Selected Configuration?

- | No
- | Yes \*

apuntes



# GENERATION S.O. SERVER



NetWare Generation And Installation V4.00

- Network Generation Options
- Select Network Configuration
  - Link/Configure NetWare Operating System
  - Link/Configure File Server Utilities
  - Exit NETGEN

Use the arrow keys to highlight an option, then press the SELECT key.

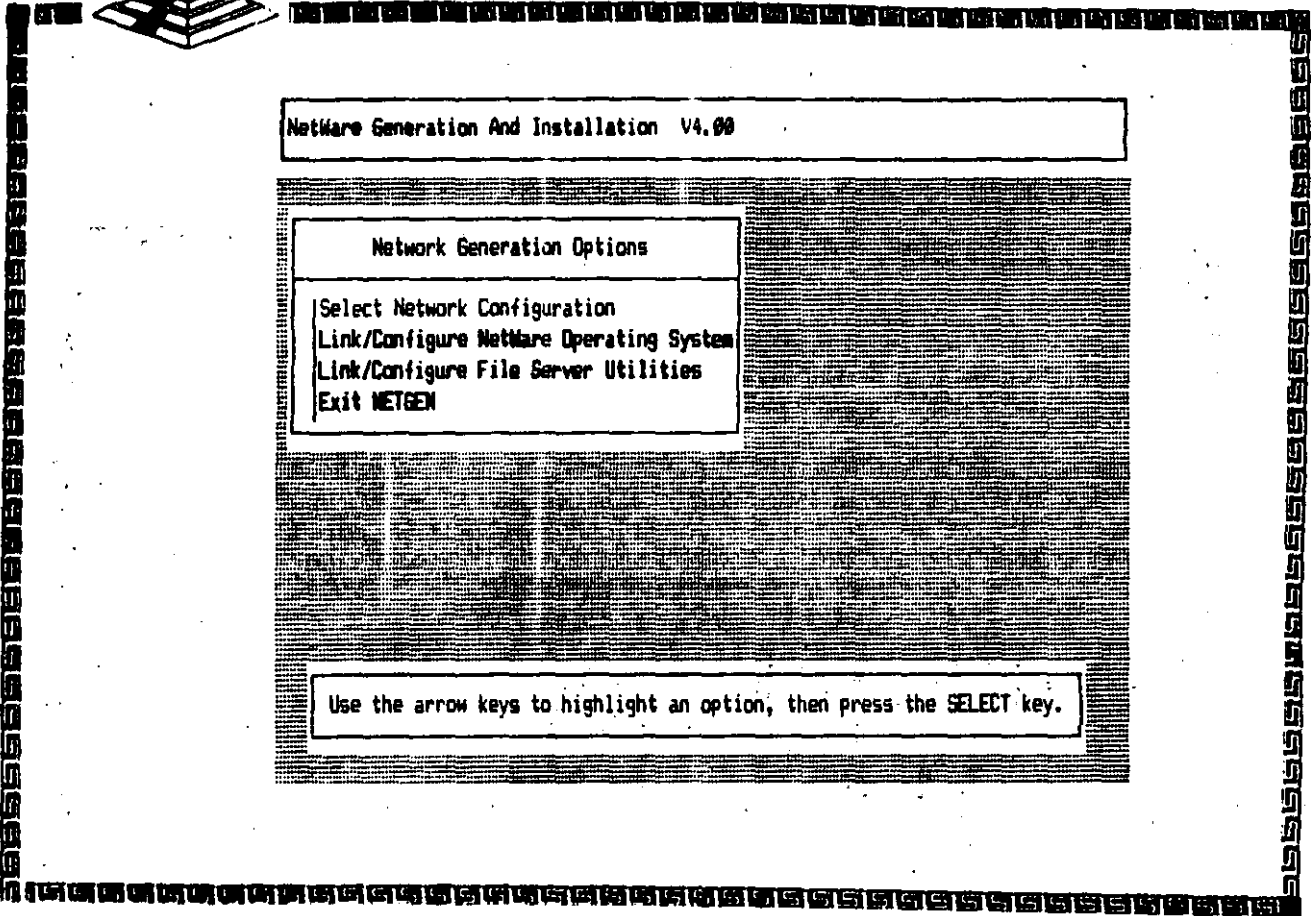

apuntes

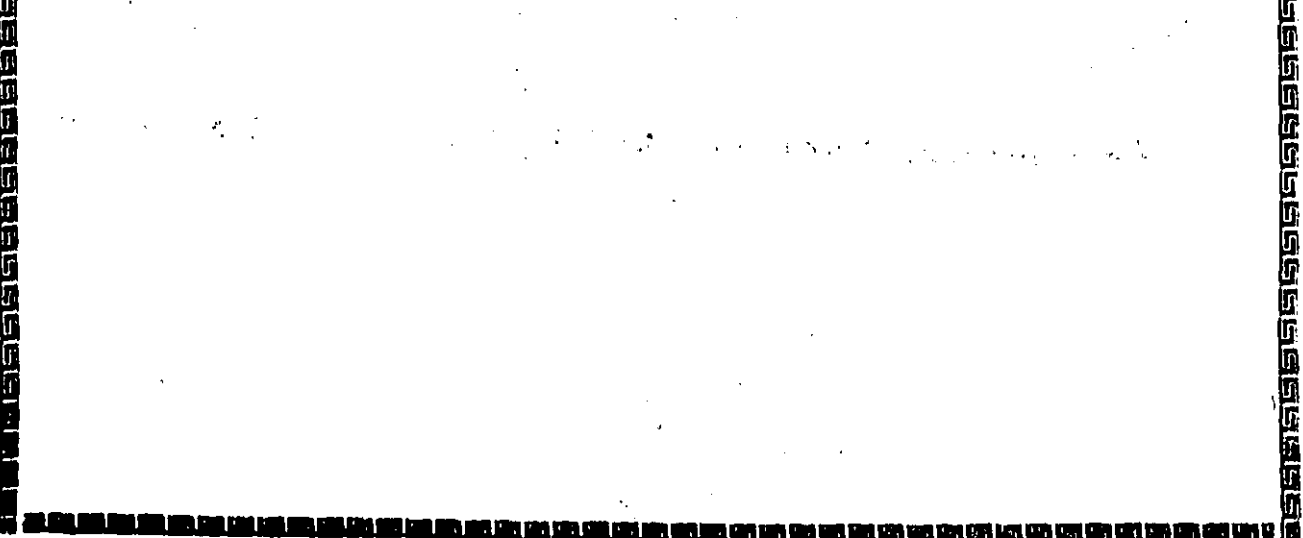



**EL SUPERVISOR  
Y SUS FUNCIONES EN  
NETWARE**

# ENTRADA A LA RED



A>ipx  
 Novell IPX/SPX V2.12  
 (C) Copyright 1985, 1988 Novell Inc. All Rights Reserved.

LAN Option: G/Ethernet PC by Gateway Communications, Inc., V2.5  
 Hardware Configuration: IRQ = 3, I/O Base = 2A0h, no DMA or ROM

A>net3  
 NetWare V2.12 rev. A - Workstation Shell for PC DOS V3.x  
 (C) Copyright 1983, 1988 Novell, Inc. All Rights Reserved.

Attached to server SERVER2  
 Monday, July 9, 1990 5:32:41 pm

A:\>f:  
 F:\LOGIN>login  
 Enter your login name: SUPERVISOR

Good afternoon, SUPERVISOR.

Drive A maps to a local disk.  
 Drive B maps to a local disk.  
 Drive C maps to a local disk.  
 Drive D maps to a local disk.  
 Drive E maps to a local disk.  
 Drive F := SERVER2/SYS:SYSTEM  
 Drive G := SERVER2/SYS:LOGIN  
 Drive Y := SERVER2/SYS:PUBLIC

SEARCH1 := Z:. (SERVER2/SYS:PUBLIC)

F:\SYSTEM>

apuntes



# MENU PRINCIPAL



F:\SYSTEM\MENU MAIN

Novell Menu System V1.22

Monday July 9, 1990 5:40 pm

## Main Menu

1. Session Management
2. File Management
3. Volume Information
4. System Configuration\*
5. File Server Monitoring
6. Print Queue Management
7. Print Job Configurations
8. Printer Definitions
9. Logout

apuntes

# CONFIG. USUARIOS Y GRUPOS



NetWare System Configuration V2.20d      Monday July 9, 1990 5:49 pm  
User SUPERVISOR On File Server SERVER2

## Available Topics

- Accounting
- Change Current Server
- File Server Information
- Group Information
- Supervisor Options
- User Information \*

apuntes

# CONFIG. USUARIOS Y GRUPOS



NetWare System Configuration V2.28d      Monday July 9, 1996 5:52 pm  
User SUPERVISOR On File Server SERVER2

| User Names                                         | available Topics                                                                                             |
|----------------------------------------------------|--------------------------------------------------------------------------------------------------------------|
| (DEFI<br>GUEST<br>SEI<br>SUPERVISOR<br>USUARIO_1 * | counting<br>nge Current Server<br>e Server Information<br>up Information<br>ervisor Options<br>r Information |

apuntes

# CONFIG. USUARIOS Y GRUPOS



NetWare System Configuration V2.20d      Monday July 9, 1990 5:54 pm  
User SUPERVISOR On File Server SERVER2

| User Names                                       | available To                                                                        | User Information                                                                                                                                                                                                                                                     |
|--------------------------------------------------|-------------------------------------------------------------------------------------|----------------------------------------------------------------------------------------------------------------------------------------------------------------------------------------------------------------------------------------------------------------------|
| DECFI<br>GUEST<br>SEI<br>SUPERVISOR<br>USUARIO_1 | counting<br>nge Current<br>e Server In<br>up Informat<br>ervisor Opt<br>r Informati | Account Balance<br>Account Restrictions<br>Change Password<br>Full Name<br>Groups Belonged To<br>Intruder Lockout Status<br>Login Script<br>Other Information<br>Security Equivalences<br>Station Restrictions<br>Time Restrictions<br>Trustee Directory Assignments |

apuntes

# CONFTG. USUARIOS Y GRUPOS



NetWare System Configuration V2.20d      Monday July 9, 1996 6:03 pm  
User SUPERVISOR On File Server SERVER2

| User Names | available To | User Information              |
|------------|--------------|-------------------------------|
| DECFI      | ounting      | Account Balance               |
| GUEST      | nge Current  | Account Restrictions          |
| SEI        | e Server In  | Change Password               |
| SUPERVISOR | up Informat  | Full Name *                   |
| USUARIO_1  | ervisor Opt  | Groups Belonged To            |
|            | r Informati  | Intruder Lockout Status       |
|            |              | Login Script                  |
|            |              | Other Information             |
|            |              | Security Equivalences         |
|            |              | Station Restrictions          |
|            |              | Time Restrictions             |
|            |              | Trustee Directory Assignments |

Full Name: ADRIAN M. C. \*

apuntes

# CONFIG. USUARIOS Y GRUPOS



NetWare System Configuration V2.20d Monday July 9, 1990 6:07 pm  
User SUPERVISOR On File Server SERVER2

| User Names | available To | User Information              |
|------------|--------------|-------------------------------|
| DECFI      | ounting      | Account Balance               |
| GUEST      | nge Current  | Account Restrictions          |
| SEI        | e Server In  | Change Password *             |
| SUPERVISOR | up Informat  | Full Name                     |
| USUARIO_1  | ervisor Opt  | Groups Belonged To            |
|            | r Informati  | Intruder Lockout Status       |
|            |              | Login Script                  |
|            |              | Other Information             |
|            |              | Security Equivalences         |
|            |              | Station Restrictions          |
|            |              | Time Restrictions *           |
|            |              | Trustee Directory Assignments |

Enter New Passwords \*

apuntes

# CONFTG. USUARIOS Y GRUPOS



NetWare System Configuration V2.20d      Monday July 9, 1990 6:11 pm  
User SUPERVISOR On File Server SERVER2

## Allowed Login Times For User SUPERVISOR

|   |                     |                         |     |
|---|---------------------|-------------------------|-----|
|   | AM                  |                         | PM  |
| 1 |                     | 1 1 1                   | 1 1 |
| 2 | 1 2 3 4 5 6 7 8 9 0 | 1 2 1 2 3 4 5 6 7 8 9 0 | 1   |

|           |       |
|-----------|-------|
| Sunday    | ***** |
| Monday    | ***** |
| Tuesday   | ***** |
| Wednesday | ***** |
| Thursday  | ***** |
| Friday    | ***** |
| Saturday  | ***** |

Monday 12:00 pm To 12:30 pm

apuntes

# CONFIG. USUARIOS Y GRUPOS



NetWare System Configuration V2.20d Monday July 9, 1990 6:15 pm  
User SUPERVISOR On File Server SERVER2

## Account Restrictions For User SUPERVISOR

|    |                                  |          |
|----|----------------------------------|----------|
|    | Account Disabled:                | No       |
|    | Account Has Expiration Date:     | No       |
|    | Date Account Expires:            |          |
| DE | Limit Concurrent Connections:    | No       |
| SU | Maximum Connections:             |          |
| SE | Allow User To Change Passwords:  |          |
| SU | Require Password:                | No       |
| US | Minimum Password Length:         | 8        |
| US | Force Periodic Password Changes: |          |
| US | Days Between Forced Changes:     |          |
| US | Date Password Expires:           |          |
| US | Limit Grace Logins:              |          |
| US | Grace Logins Allowed:            |          |
| US | Remaining Grace Logins:          | Comments |
| US | Require Unique Passwords:        |          |
|    | Limit Server Disk Space:         | No       |
|    | Maximum Server Disk Space (KB):  |          |

apuntes



# CONFTG. USUARIOS Y GRUPOS



NetWare System Configuration V2.20d Monday July 9, 1999 7:14 pm  
User SUPERVISOR On File Server SERVER2

| User Names                                       | available To                                                                       | Groups Belonged To |
|--------------------------------------------------|------------------------------------------------------------------------------------|--------------------|
| DECF1<br>GUEST<br>SE1<br>SUPERVISOR<br>USUARIO_1 | ounting<br>nge Current<br>e Server In<br>up Informat<br>ervisor Opt<br>r Informati | EVERYONE           |

nts

apuntes

# CONFTG. USUARIOS Y GRUPOS



NetWare System Configuration V2.29d Monday July 9, 1990 7:17 pm  
User SUPERVISOR On File Server SERVER2

| User Names | available To | User Information        |
|------------|--------------|-------------------------|
| DECFI      | ounting      | Account Balance         |
| GUEST      | nge Current  | Account Restrictions    |
| SEI        | e Server In  | Change Password         |
| SUPERVISOR | up Informat  | Full Name               |
| USUARIO_1  | ervisor Opt  | Groups Belonged To      |
| USUARIO_10 | r Informati  | Intruder Lockout Status |
| USUARIO_11 |              | Login Script            |
| USUARIO_2  |              | Other Information       |
| USUARIO_3  |              |                         |
| USUARIO_4  |              |                         |
| USUARIO_5  |              |                         |
| USUARIO_6  |              |                         |
| USUARIO_7  |              |                         |

|                               |                         |
|-------------------------------|-------------------------|
| Last Login:                   | July 9, 1990 7:12:54 pm |
| File Server Console Operator: | Yes                     |
| Maximum Server Disk Usage:    | Unrestricted            |
| Disk Space In Use:            | 0K                      |
| User ID:                      | 00000001                |

apuntes

# CONFIG. USUARIOS Y GRUPOS



NetWare System Configuration V2.20d      Monday July 9, 1990 7:19 pm  
User SUPERVISOR On File Server SERVER2

| User Names | Allowed Login Addresses | User Information |
|------------|-------------------------|------------------|
| DECFI      |                         | Balance          |
| GUEST      |                         | Restrictions     |
| SEI        |                         | password         |
| SUPERVISOR |                         | email            |
| USUARIO_1  |                         | Belonged To      |
| USUARIO_10 |                         | Lockout Status   |
| USUARIO_11 |                         | privilege        |
| USUARIO_2  |                         | Profile          |
| USUARIO_3  |                         |                  |
| USUARIO_4  |                         |                  |
| USUARIO_5  |                         |                  |
| USUARIO_6  |                         |                  |
| USUARIO_7  |                         |                  |

Network Address:  
Directory Assignments

apuntes

# CONFIG. USUARIOS Y GRUPOS



NetWare System Configuration V2.28d      Monday July 9, 1990 7:22 pm  
User SUPERVISOR On File Server SERVER2

Login Script For User SUPERVISOR

apuntes

# CONFTE. USUARIOS Y GRUPOS



NetWare System Configuration V2.26d      Monday July 9, 1990 7:56 pm  
User SUPERVISOR On File Server SERVER2

### Available Topics

- | Accounting
- | Change Current Server
- | File Server Information
- | Group Information \*
- | Supervisor Options
- | User Information

apuntes

# CONFIG. USUARIOS Y GRUPOS



NetWare System Configuration V2.20d Monday July 9, 1990 8:06 pm  
User SUPERVISOR On File Server SERVER2

| Group Names           | vailable Topics                                                                                              |
|-----------------------|--------------------------------------------------------------------------------------------------------------|
| EVERYONE<br>GRUPO_1 * | counting<br>ngs Current Server<br>e Server Information<br>up Information<br>ervisor Options<br>r Information |

apuntes

# CONFTG. USUARIOS Y GRUPOS



NetWare System Configuration V2.29d      Monday July 9, 1990 8:08 pm  
User SUPERVISOR On File Server SERVER2

| Group Names           | available To                                                                         | Group Information                                                              |
|-----------------------|--------------------------------------------------------------------------------------|--------------------------------------------------------------------------------|
| EVERYONE<br>GRUPO_1 * | ounting<br>nge Current<br>e Server In<br>up Informat<br>ervisor Opt<br>r Information | Full Name<br>Member List<br>Other Information<br>Trustee Directory Assignments |

apuntes

# CONFTG. USUARIOS Y GRUPOS



NetWare System Configuration V2.20d      Monday July 9, 1990 8:12 pm  
User SUPERVISOR On File Server SERVER2

| Group Names         | available To                                                                         | Group Information                                                                |
|---------------------|--------------------------------------------------------------------------------------|----------------------------------------------------------------------------------|
| EVERYONE<br>GRUPO_1 | ounting<br>nge Current<br>e Server In<br>up Informat<br>ervisor Opt<br>r Information | Full Name *<br>Member List<br>Other Information<br>Trustee Directory Assignments |
|                     |                                                                                      | Full Name: GRUPO DE DESARROLLO                                                   |

apuntes



# CONFIG. USUARIOS Y GRUPOS



NetWare System Configuration V2.20d      Monday July 9, 1990 8:14 pm  
User SUPERVISOR On File Server SERVER2

| Group Names         | available To                                                                         | Group Members                            |
|---------------------|--------------------------------------------------------------------------------------|------------------------------------------|
| EVERYONE<br>GRUPO_1 | ounting<br>nge Current<br>e Server In<br>up Informat<br>ervisor Opt<br>r Information | GUEST<br>SUPERVISOR<br>USER<br>USUARIO_1 |

apuntes

# CONFIG. USUARIOS Y GRUPOS



NetWare System Configuration V2.20d      Tuesday July 10, 1990 6:36 pm  
User SUPERVISOR1 On File Server SERVER1

| Group Names | va | Trustee Directory Assignments |             |
|-------------|----|-------------------------------|-------------|
| EVERYONE    | ou | SYS:MAIL                      | [ M C ]     |
| GRUPO_1     | ng | SYS:PUBLIC                    | [ RMOCPSM ] |
|             | e  | SYS:TRABAJO/GRUPO_3/PRUEBA    | [ RMOCPSM ] |
|             | up | SYS:TRABAJO/GRUPO_4/FILES     | [ S ]       |
|             | er |                               |             |
|             | r  |                               |             |

apuntes

# MANEJO DE ARCHIVOS



Novell Menu System V1.22

Tuesday July 10, 1990 7:00 pm

## Main Menu

1. Session Management
2. File Management \*
3. Volume Information
4. System Configuration
5. File Server Monitoring
6. Print Queue Management
7. Print Job Configurations
8. Printer Definitions
9. Logout

apuntes

# MANEJO DE ARCHIVOS



NetWare File Maintenance V1.35a      Tuesday July 10, 1998 7:14 pm  
SERVER1/SYS:LOGIN

- Available Topics
- Current Directory Informations
  - File Information
  - Select Current Directory
  - Set Filer Options
  - Subdirectory Information
  - Volume Information

apuntes

# MANEJO DE ARCHIVOS



NetWare File Maintenance V1.35a      Tuesday July 16, 1990 7:16 pm  
SERVER1/SYS:LOGIN

### Available Topics

Current Directory Information  
File Information

### Current Directory Information

Creation Date  
Current Effective Rights  
Maximum Rights Mask  
Owner  
Trustees

Current Directory  
Options  
Directory Information  
Creation

apuntes

# MANEJO DE ARCHIVOS



NetWare File Maintenance V1.35a      Tuesday July 18, 1998 7:17 pm  
SERVER1/SYS:LOGIN

|                               |                       |
|-------------------------------|-----------------------|
| Available Topics              |                       |
| Current Directory Information | Current Directory     |
| File Information              | Options               |
| Current Directory Information | Directory Information |
| Creation Date *               | Creation              |
| Current Effective Rights      |                       |
| Maximum Rights Mask           |                       |
| Owner                         |                       |
| Trustees                      |                       |

Directory Creation Date: June 26, 1989

apuntes

# MANEJO DE ARCHIVOS



NetWare File Maintenance V1.35a      Tuesday July 10, 1990 7:20 pm  
SERVER1/SYS:LOGIN

## Available Topics

Current Directory I  
File Information

## Maximum Rights

### Current Directory Information

Creation Date  
Current Effective Rights  
Maximum Rights Mask \*  
Owner  
Trustees

rent Dire  
Options  
ry Inform  
ormation

Create New Files  
Delete Files  
Modify File Names/Flags  
Open Existing Files  
Parental Rights  
Read From Files  
Search For Files  
Write To Files

apuntes

# MANEJO DE ARCHIVOS



NetWare File Maintenance V1.35a      Tuesday July 10, 1990 7:23 pm  
SERVER1/SYS1/LOGIN

### Available Topics

Current Directory Information  
File Information

### Current Directory Information

Creation Date  
Current Effective Rights  
Maximum Rights Mask  
Owner \*  
Trustees

Current Directory  
Options  
Directory Information  
Creation

Directory Owner: SUPERVISOR

apuntes





**INSTALACION DE  
ELEMENTOS ESPECIALES**

*SFT/Advanced NetWare 286 Installation*

---

You must set all UPS-related jumpers on the hardware you will be using for UPS monitoring. Instructions for setting these jumpers are given in the supplements listed below:

| <b>UPS Monitoring Hardware</b> | <b>Go to Supplement</b>                                                   |
|--------------------------------|---------------------------------------------------------------------------|
| SS keycard                     | <i>NetWare Installation Supplement for Novell Keycards</i>                |
| Disk coprocessor board         | <i>NetWare Installation Supplement for Novell Disk Coprocessor Boards</i> |
| Standalone UPS monitor board   | <i>NetWare Installation Supplement for Novell Disk Coprocessor Boards</i> |

## **INSTALLING DISK COPROCESSOR BOARDS IN THE FILE SERVER**

If you are attaching any external NetWare disk subsystems to your file server, you must install one or more disk coprocessor boards. A disk coprocessor board serves as the communication interface between the file server and all of the hard disks in a single hard disk channel. A disk coprocessor board frees the file server's CPU for other important operating system tasks.

The NetWare 286 operating system can handle up to four external hard disk channels; therefore, you can install up to four disk coprocessor boards in the file server.

For complete instructions on installing a disk coprocessor board, see the *NetWare Installation Supplement for Novell Disk Coprocessor Boards*.

## **INSTALLING FILE SERVER BOARDS**

If you will be installing UPS monitoring hardware, disk coprocessor boards, or other circuit boards, continue with the instructions in this section.

If you will not be installing any other file server boards, skip to "Attaching File Server Peripherals" on page 5-18.

## **INSTALLING UPS MONITORING HARDWARE IN THE FILE SERVER**

A Novell-approved uninterruptible power supply (UPS) should be attached to each file server in a NetWare 286 v2.15 network to provide backup power if the commercial power fails. A UPS can also be attached to workstations on the network without installing any kind of UPS monitoring hardware.

If you are not installing a UPS on your network, skip to "Installing Disk Coprocessor Boards in the File Server" on page 5-16.

In order for your file server to use a Novell-approved UPS, you must make the appropriate settings on the UPS monitor board and insert the board into the computer. You can use any one of the following as the UPS monitor board:

- SS keycard with UPS monitoring
- Disk coprocessor board (37-pin version)
- Standalone UPS monitor board

If you have an early version of the disk coprocessor board that is not equipped with the UPS monitoring capability, you will need a standalone UPS monitor board in addition to the disk coprocessor board. The standalone UPS monitor board is documented in the *NetWare Installation Supplement for Novell Disk Coprocessor Boards*. (Standalone UPS monitor boards are available from Novell.)

---

## **INSTALLING OTHER CIRCUIT BOARDS IN THE FILE SERVER**

If you need to install additional hardware (such as memory add-on boards and asynchronous communications adapters) that is not related to the network, install it now. Refer to the documentation that came with the hardware for instructions.

Be sure that as you install circuit boards, you set the hardware to the configuration settings you selected in NETGEN and SHGEN. These settings should be recorded on copies of the "NetWare File Server Configuration Worksheet" and the "NetWare Workstation Configuration Worksheet." These settings are also recorded in files labeled CONFIG.DAT on the *SUPPORT* (5.25-inch format) or *NETGEN* (3.5-inch format) diskette for the file server.

When you have finished installing all of the internal file server hardware, replace the file server cover.

If you are installing any file server peripherals, continue with the appropriate section.

UPS power unit      page 5-20

External hard disks      page 5-21

Network printers      page 5-25

If you do not plan to attach any peripherals to your file server at this time, skip to Chapter 6.

## **ATTACHING FILE SERVER PERIPHERALS**

You should have prepared all peripherals that you plan to attach to the file server in accordance with the instructions in Chapter 2. You should have also recorded the specified information about the peripherals on the appropriate installation worksheets. If you have not done this, return to "Preparing File Server Peripherals" on page 2-8 and complete the hardware preparation steps outlined there. Then return to this page.

## **ATTACHING A UPS TO THE FILE SERVER**

Before you attach the UPS power unit to the file server, you should have installed the UPS monitoring hardware as explained in Chapter 2.

Once you have installed the UPS monitoring hardware in the file server, you are ready to connect the UPS to the file server by means of the UPS monitor cable supplied by your UPS manufacturer.

One end of the monitor cable should have either a stereo phone plug (for plugging into the standalone UPS monitor board, SS keycard, or disk coprocessor board in a non-PS/2 file server) or a 4-pin "mouse" plug (for plugging into the mouse port of an IBM PS/2 file server). The other end of the monitor cable should have the type of connector required by your particular UPS. (If you use UPS monitoring with a nondedicated IBM PS/2 file server, you will not be able to use a mouse, since the UPS monitor cable is connected to the mouse port.)

The procedure for connecting the UPS monitor cable to the file server varies according to the type of file server you have. In general, you must connect one end of the cable to the UPS monitoring hardware in the file server and the other end of the cable to the UPS power unit itself. Then you must properly connect the UPS and file server power cables.

If you have a non-PS/2 file server (such as a Novell file server, an IBM PC AT, or any UL-recognized IBM PC AT-compatible), connect the UPS monitor cable according to the instructions in the following section.

If you have an IBM PS/2 Model 30(286), 50, 50Z, 60, 70, or 80 file server, connect the UPS monitor cable according to the instructions on page 5-20.

## CONNECTING THE UPS MONITOR CABLE TO A NON-PS/2 FILE SERVER

If you have installed a standalone UPS monitor board, an SS keycard, or a disk coprocessor board in a non-PS/2 file server, plug the stereo phone plug on the end of the UPS monitor cable into the jack on the UPS monitoring hardware, as shown in Figure 5.2. If you have more than one disk coprocessor board, be sure to connect the UPS cable to the board on which you set the UPS jumpers. You should have identified this board with "UPS" on the mounting bracket when you set the jumpers.

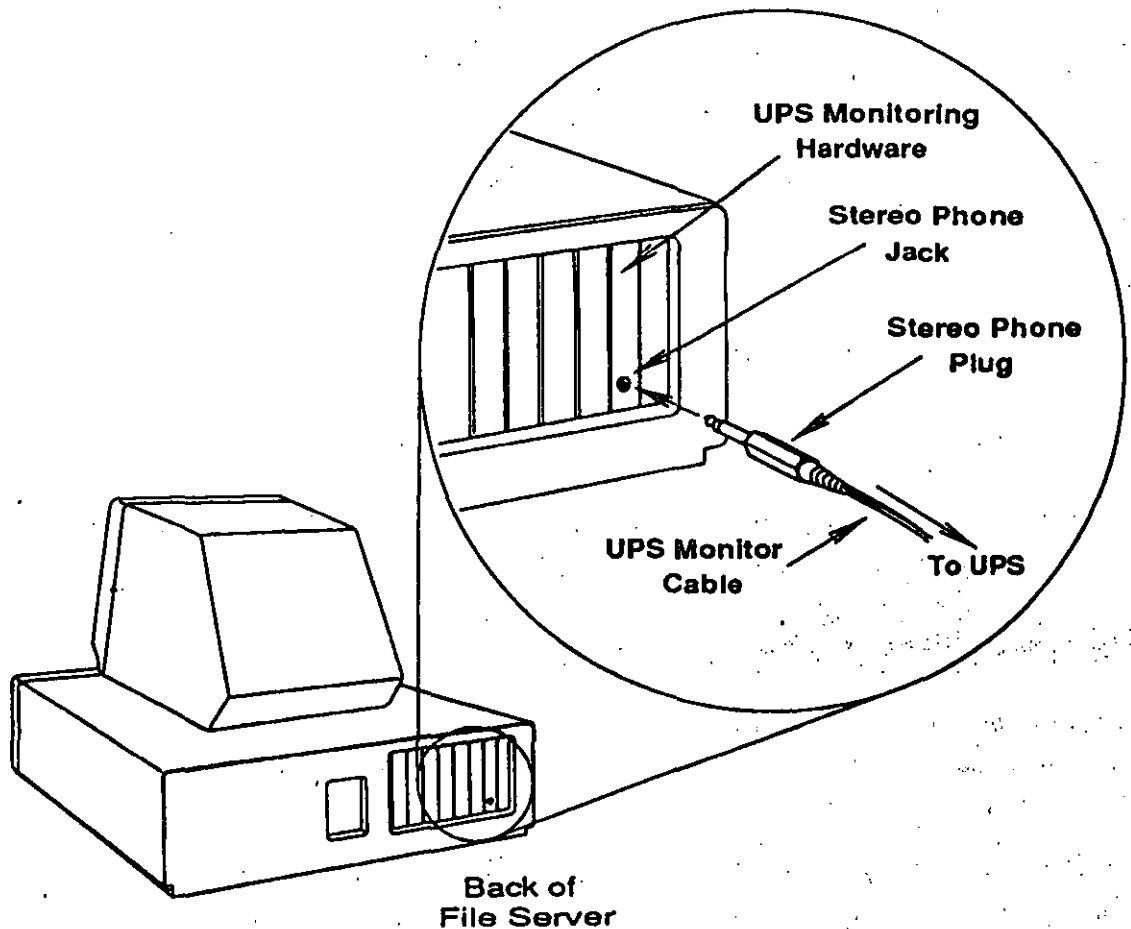
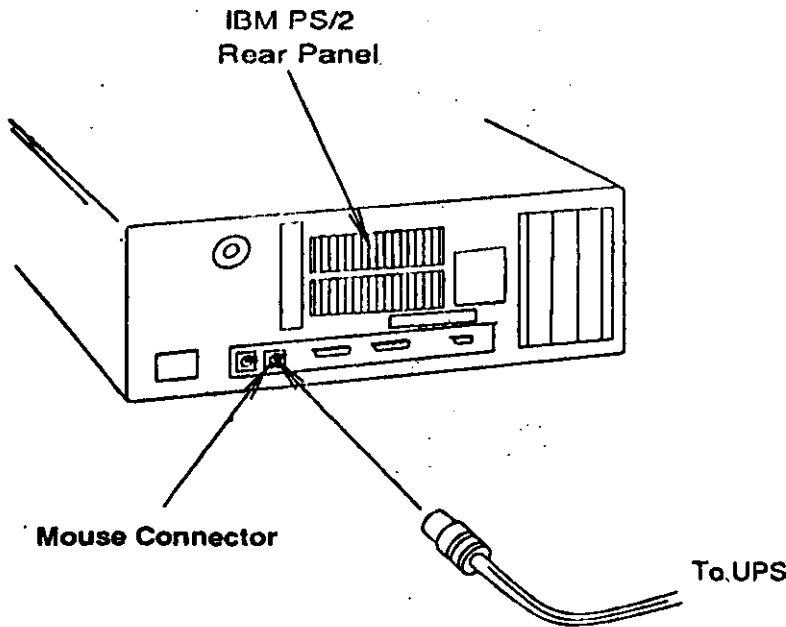

Figure 5.2  
Connecting a UPS Monitor Cable to a  
Non-PS/2 File Server

### **CONNECTING THE UPS MONITOR CABLE TO A PS/2 FILE SERVER**

If you are attaching a UPS to an IBM PS/2 file server, plug the 4-pin mouse connector on the end of the UPS monitor cable into the mouse port on the rear panel of the PS/2, as shown in Figure 5.3.



**Figure 5.3**  
**Connecting a UPS Monitor Cable to a PS/2 File Server**

### **CONNECTING THE UPS POWER UNIT**

After you connect the UPS monitor cable to the file server, refer to your UPS documentation for instructions on how to connect the UPS monitor cable to the UPS power unit.

Your UPS may allow you to supply power to another unit (or units) in addition to the file server. Plug the power cord of each unit into the appropriate socket of the UPS according to the UPS documentation.

See your UPS documentation to complete any other steps that apply to your particular UPS.

---

## **ATTACHING EXTERNAL HARD DISKS TO THE FILE SERVER**

The instructions below explain how to attach external hard disks to the file server. In a NetWare 286 installation, external hard disks can be either Novell-formatted and tested hard disks in NetWare disk subsystems or third-party hard disks (that have not been formatted and tested by Novell).

If you are not attaching any external hard disks to the file server, skip to "Attaching Network Printers to the File Server" on page 5-25.

## **ATTACHING THIRD-PARTY HARD DISKS TO THE FILE SERVER**

If you have any third-party hard disks to attach to the file server, refer to the instructions provided by the third-party vendor.

## **ATTACHING NOVELL DISK SUBSYSTEMS TO THE FILE SERVER**

The instructions below explain how to attach Novell disk subsystems to their respective disk coprocessor boards in the file server. You should read all of the information under this subheading (through page 5-25) before actually attaching the subsystems.

Novell disk subsystems contain Novell-formatted and tested hard disk drives that are used to expand the data storage capacity of an NetWare 286 network. The NetWare 286 v2.1x operating system supports the following Novell disk subsystems:

- Novell Disk Subsystem 2 (NDS2)
- Novell Disk Subsystem 4 (NDS4)
- Original NetWare Disk Subsystem (any NetWare disk subsystem manufactured before the NDS2 and NDS4)

The NDS2 and the NDS4 are currently the available disk subsystems. Original NetWare disk subsystems are no longer available.

The NDS2 and the original disk subsystem each have one hard disk controller board that supports one or two hard disk drives.



## SFT/Advanced NetWare 286 Installation

---

The NDS4 may have two controller boards or four embedded SCSI boards, each supporting one or two hard disk drives.

As you read and follow the instructions, be sure to differentiate between a disk coprocessor board and a hard disk controller board. The differences are explained below.

- A *disk coprocessor board* is a full-size circuit board that is installed in an expansion slot in the file server. It controls the communications interface between the file server and all of the hard disks on a particular channel.
- Each hard disk in a particular channel is, in turn, connected to some type of *hard disk controller board*. A controller board can be located (1) within a Novell disk subsystem; (2) within the hard disk housing itself (this is called an "Embedded SCSI" controller); or (3) adjacent to the internal disk drives in a file server. Each controller board can control the functions of either one or two hard disk drives. Currently, only Adaptec-brand controller boards and Embedded SCSI-type hard disks are supported by NetWare 286.

### Checking the Disk Subsystem Preparation

The hard disks and disk subsystems should have been prepared as explained in Chapter 2, and all pertinent information about them should have been recorded on the appropriate worksheets. A valid controller address must be correctly set on each of the controller boards, and the proper termination should be installed at the ends of each channel chain.

If these preparations have not been made, return to "Preparing External Hard Disk Drives for Installation" on page 2-8 and complete the instructions in that section. Then return to this point.

If you plan to use disk mirroring or disk duplexing in your SFT NetWare 286 Level II network, keep the following points in mind as you install your disk subsystems:

- Disk subsystems should be placed so that disks to be mirrored together will be attached to the same disk coprocessor board. (You can mirror disks within either the same or different disk subsystems, as long as they are connected to the same hard disk channel.)

- Disk subsystems should be placed so that disks to be duplexed together will be attached to different disk coprocessor boards. (You can duplex disks within either the same or different disk subsystems, as long as they are connected to different hard disk channels.)
- Disk drives paired together with disk mirroring or disk duplexing should have identical storage capacities.

### **Attaching a Single Disk Subsystem to a Hard Disk Channel**

The information below summarizes how to attach a single, properly prepared disk subsystem with no more than two disk drives to a disk coprocessor board. A single disk subsystem may be an NDS2, an NDS4 with no more than two disk drives, or an original disk subsystem.

The following steps illustrate how to attach a single NDS2 disk subsystem that contains one or more hard disks that do not have SCSI boards. Refer to the disk subsystem documentation for exact instructions for attaching other types of single disk subsystems.

- 1) Attach the 37-pin end of the 37-to-50-pin disk interface cable to the disk coprocessor board's 37-pin port on the back of the file server's rear panel, as shown in Figure 5.4 on the next page. (If you have an earlier version of the disk coprocessor board that has a 50-pin disk interface port, use a 50-to-50-pin cable.) Use a screwdriver to fasten the cable connector to the port.

---

#### **NOTE:**

A two-foot disk interface cable is shipped with each disk subsystem. Longer disk interface cables are available by special order.

---

- 2) Connect the 50-pin end of the disk interface cable to the right-most of the two 50-pin ports on the rear panel of the disk subsystem. (If the cable ports on the rear panel of your disk subsystem are labeled INPUT and OUTPUT, connect the disk interface cable to the port labeled INPUT.)

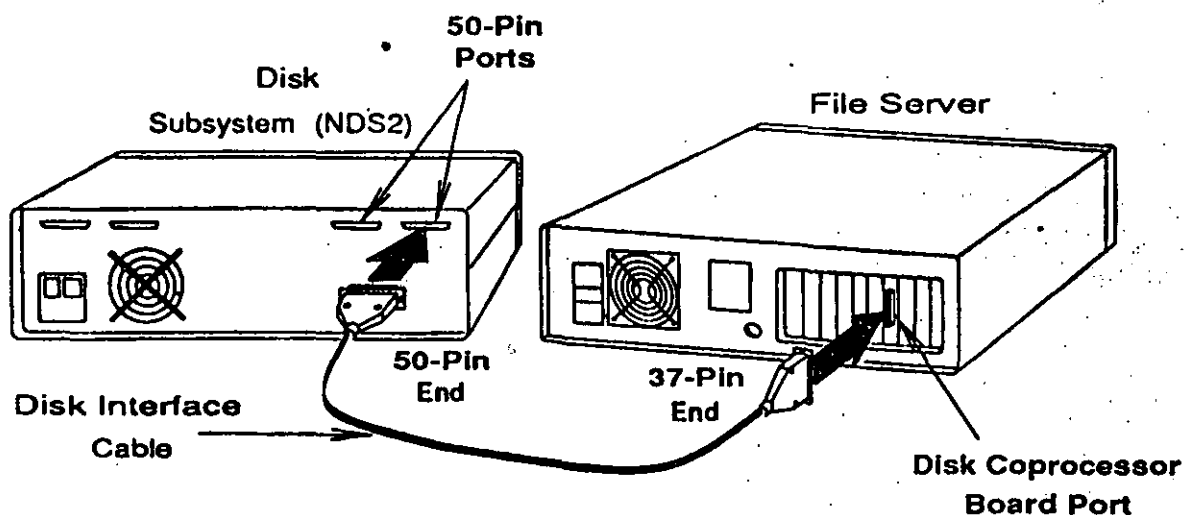

**Figure 5.4**  
**Attaching a Single Disk Subsystem to the File Server**

- 3) Connect the disk subsystem power cord to the rear panel of the subsystem, and plug the power cord into an appropriate AC power source (or into the UPS power unit, if applicable).

Repeat this process for any other installed disk coprocessor board to which you plan to attach a single disk subsystem.

If you have completed attaching disk subsystems to all disk coprocessor boards, skip to "Attaching Network Printers to the File Server" on page 5-25.

If you have another disk coprocessor board installed to which you plan to attach more than one disk subsystem, follow the instructions in the next section.

### Chaining Disk Subsystems in a Hard Disk Channel

You can chain as many as eight hard disk controller boards to a single disk coprocessor board. For an explanation of how to chain the controller boards together and attach them to a disk coprocessor board, refer to the disk subsystem documentation.

By following the instructions in that documentation you must do the following:

- Arrange the controller boards to be connected to each disk coprocessor board in the physical order you want them to be connected.
- If you are connecting hard disk subsystems containing hard disks without Embedded SCSIs, remove any terminating resistors from all but the last disk controller board in each chain.

If you are connecting hard disk subsystems containing hard disks with Embedded SCSIs, remove any terminating resistors from the SCSI adapters on the back of all but the last subsystem in each chain.

- Make sure the last disk controller board in the chain is terminated.
- Connect the cabling from the disk coprocessor board to the first disk subsystem, from the first disk subsystem to the second, and so on until all subsystems in the chain are connected.

After you have completed connecting all subsystems in each chain, continue with the instructions in the next section.

## **ATTACHING NETWORK PRINTERS TO THE FILE SERVER**

The following instructions explain how to attach network printers to the file server. If you are not attaching any printers to the file server at this time, skip to Chapter 6.

All network printers should have been prepared as explained under "Preparing Network Printers for Installation" on page 2-13. If you have not yet completed this printer preparation, do so now.

Once the printers have been properly prepared for installation, follow the instructions under the appropriate section below, depending on whether you are attaching serial printers or parallel printers. Refer to the information you recorded in the "Network Printers" section of the "NetWare Installation Parameters Worksheet" to make sure you attach the correct printer to the correct printer port on the file server.

**ATTACHING SERIAL PRINTERS**

To attach serial printers to the file server, complete these steps:

- 1) Make sure the serial printers are set to use the communication parameters (such as baud rate and word length) that you have recorded for them on the "NetWare Installation Parameters Worksheet" (see page 2-14).
- 2) Connect all serial printers to the file server with the necessary hardware. Do so according to the instructions supplied by the manufacturers of the printer hardware and the computer you are installing as a file server.
- 3) Connect the printer power cords to an appropriate AC power source.

**ATTACHING PARALLEL PRINTERS**

To attach parallel printers to the file server, complete the steps below. Parallel printers require no hardware or software communication parameters.

- 1) Connect all parallel printers to the file server with the necessary hardware. Do so according to the instructions supplied by the manufacturers of the printer hardware and the personal computer you are installing as a file server.
- 2) Connect the printer power cords to an appropriate power source.

## **2 GENERATING THE BRIDGE SOFTWARE**

---

This chapter describes how to use the BRGEN utility to generate the bridge software used to connect a network to a LAN, a remote LAN, or a remote workstation.

If the bridge establishing a connection with a remote workstation is already installed and running, skip to Chapter 6, "Setting Up the NetWare Remote Workstation," to generate and configure the workstation shell and to install the hardware in the remote workstation.

In this chapter, you will do the following:

- Make working copies of the installation diskettes.
- Load the BRGEN software.
- Run the BRGEN utility, using the "Default Configuration" method to generate the bridge software.

If you are installing a remote bridge, you will use two software programs: BRGEN to generate the bridge software and ARCONFIG to configure the bridge software. In addition, if you are connecting with a remote workstation, you will use SHGEN to generate a remote workstation shell and ARCONFIG to configure the remote workstation shell. You may also use the LCONSOLE utility to communicate with the bridge once it has been brought up.

Instructions for running ARCONFIG to configure the bridge software are in Chapter 3. Instructions for running SHGEN and ARCONFIG to generate and configure the remote workstation shell are in Chapter 6. Instructions for running LCONSOLE are in Chapter 7.

The following instructions will guide you through the bridge software generation for an external bridge.

## GETTING STARTED

To generate the bridge software using the BRGEN utility, you should first make working copies of the installation diskettes and then load BRGEN.

### MAKING WORKING COPIES OF THE INSTALLATION DISKETTES

Whether you run BRGEN from floppy diskettes, a local hard disk, or the network, we strongly recommend that you make working copies of all your NetWare 286 installation diskettes to use as you run the programs. This practice ensures that you will always have a backup copy should anything happen to the working copies.

In order to generate NetWare software, you need to make working copies of the following NetWare diskettes:

#### **5.25-inch diskettes**

**BRGEN-1**  
**BRGEN-2**  
**BRGEN-3**  
**LAN\_DRV\_001**  
**LAN\_DRV\_002**

#### **3.5-inch diskettes**

**BRGEN-1**  
**BRGEN-2**  
**LAN\_DRV\_001**  
**LAN\_DRV\_002**

In addition, if you have purchased WNIM or X.25 boards, you will need to make a working copy of the **LAN\_DRV\_XXX** diskette that contains the communication driver for the board you purchased. (The **XXX** represents the unique name of your diskette.) Some **LAN\_DRV\_** diskettes may contain drivers that are also located on the **LAN\_DRV\_001** or **LAN\_DRV\_002** diskettes.

To make working copies of the diskettes, follow these steps.

- 1) Boot a workstation with DOS 3.x or 4.x
- 2) Use the DOS DISKCOPY command to copy each NetWare diskette onto the new diskette.

---

**IMPORTANT:**

Do not use the DOS COPY command to make working copies of your NetWare diskettes.

The DISKCOPY command ensures that the copied diskettes are formatted correctly, have the correct volume name, and have all the directories and files of the original NetWare diskettes.

---

- 3) Label each new diskette to identify it properly.
- 4) After making working copies, store the original NetWare diskettes in a secure place. Throughout the NetWare bridge installation, whenever you are instructed to use a specific diskette, use the working copy.

## **LOADING THE BRGEN SOFTWARE**

BRGEN is designed so that it can be run from floppy disk drives, from a hard disk, or from the network, depending on the resources and needs of the installer.

To run BRGEN from a hard disk or from the network, first refer to Appendix C. When you finish with the instructions in Appendix C, continue with "Running the BRGEN Utility" on the next page.

To run BRGEN from floppy diskettes, you will need a personal computer that

- Has at least 640KB of memory;
- Runs DOS 3.x or 4.x;
- Has at least one, but preferably two, floppy disk drives.

The computer used to run this program does not have to be running as part of a current network.



## **RUNNING THE BRGEN UTILITY**

The following instructions apply whether you are running the BRGEN program from a floppy diskette, a hard disk, or the network, although instances are noted that apply only to a particular method. (If you will be running BRGEN from a hard disk or the network, you should have already completed the instructions in Appendix C.)

---

### **NOTE:**

On-line help screens are provided with the BRGEN utility. To access the on-line help, press the F1 key. Press the F1 key a second time to view the function key assignments on your keyboard. Press < Escape > to return to the utility.

If you want to exit the BRGEN utility at any time, you may highlight the "Exit BRGEN" option if it appears on the screen and press < Enter >. If this option does not appear in the window you are currently viewing, press < Alt > < F10 > to exit the utility.

---

If you are running BRGEN from floppy diskettes, insert the diskette labeled *BRGEN-1* into drive A before you begin. If you have two floppy disk drives, insert the *AUXGEN* diskette into drive B. If you have only one floppy disk drive, you will be prompted to exchange diskettes while running BRGEN. Follow the instructions given on the screen. If you are running BRGEN from the hard disk or the network, make sure you are mapped to the drive where the BRGEN utility is installed.

- 1) At the DOS prompt, type

```
BRGEN -n < Enter >
```

The "-n" flag signifies that you want to start a new session of BRGEN. The utility will ignore any data that has previously been collected and start over. Always add the "-n" flag when you run BRGEN to generate bridge files for a particular workstation/network interface board combination.

The following window will appear on the screen:

System Configuration Method

Default Configuration

Custom Configuration

If you are installing a bridge using network interface boards supported by Novell, select the "Default Configuration" method. As you get farther into the program, choosing the Default method will provide you with as many defaults as possible, requiring your input only where a default setting is not possible. Most networks can be installed using the Default method.

If you need to define resources and resource sets, select the "Custom Configuration" method. With the Custom method, each piece of nonbridge-related hardware within the bridge is considered a "resource" (such as a graphics adapter or a parallel printer port), and each resource is defined by its interrupt lines, DMA channels, I/O addresses, or memory addresses. The resources can then be configured along with the rest of the drivers to ensure that no hardware conflict will occur. The resource definitions for commonly used hardware are included on the NetWare diskettes. Experienced installers can also create their own resource definitions for items not included in the standard set.

Selecting the Custom method will also let you customize default options according to the particular needs of the bridge. We recommend that only experienced NetWare installers use the Custom level.

- 2) Highlight the method you want to use and press < Enter >.

If you selected "Custom Configuration," skip to Appendix B for instructions on running the utility.

If you selected "Default Configuration," continue with "Using the Default Configuration Method" on the next page.

## **USING THE DEFAULT CONFIGURATION METHOD**

The "Default Configuration" method will configure your drivers automatically. If you do not want to use the driver configurations BRGEN selects, you may reject the default selections and choose the configurations manually. (See "Selecting a Driver Configuration Manually" on page 2-14.)

After you select "Default Configuration," the following window will appear on the screen:

Bridge Generation Options

Select Bridge Configuration

Exit BRGEN

- 1) Highlight "Select Bridge Configuration" and press <Enter>.

The message "Loading Files. Please Wait." will appear on the screen momentarily, followed by a heading similar to the following:

Bridge Configuration V4.00 Tuesday, May 2, 1989 7:55 am

The "Available Options" menu will also appear:

Available Options

Select Bridge Type

Select LAN Drivers

Save Selections and Continue

## **SELECTING BRIDGE TYPE**

- 2) Highlight "Select Bridge Type" and press < Enter >. The "Select Bridge Type" window will appear on the screen. (Refer to Chapter 1 for an explanation of protected- and real-mode bridges.)

Select Bridge Type

Real Mode Bridge

Protected Mode Bridge

- 3) Highlight your selection and press < Enter >. You are returned automatically to the "Available Options" window.

## **SELECTING BRIDGE LAN DRIVERS**

- 4) Highlight "Select LAN Drivers" and press < Enter >.

Two windows will appear on the screen. The first window, "Selected LAN Drivers," will be empty. The second window will contain the following options:

LAN Driver Options

Select Loaded Item

Load and Select Item

- 5) Highlight "Select Loaded Item" and press < Enter >.

An "Available LAN Drivers" window will appear, containing a list of available LAN drivers. You can scroll the list by using the Up- and Down-arrow keys. If the drivers you need appear in the window, skip to Step 8.

If you are running BRGEN from floppy diskettes and your driver does not appear in the window, you must load it into the program. The *LAN\_DRV\_001* and *LAN\_DRV\_002* diskettes contain the drivers that have already been loaded into the BRGEN program. Continue with Step 6.

If you are installing a WNIM or an X.25 board, you must load the driver from the *LAN\_DRV\_XXX* diskette that came with the board. Continue with Step 6.

If you are attaching Macintosh workstations, you must load the AppleTalk Ethernet driver. Choose between 3Com 3C505 EtherLink Plus With AppleTalk and NetWare NL-1000 & NL/2 (AppleTalk). Continue with Step 6.

- 6) Press <Escape> to return to the "LAN Driver Options" window.
- 7) Highlight "Load and Select Item" and press <Enter>. Then follow the instructions given on the screen to load additional drivers from floppy diskettes.

---

**NOTE:**

If you have been running BRGEN from a hard disk or from the network, you could not load and select a driver from a floppy diskette. Additional drivers had to be copied into network subdirectories, as described in Appendix C.

- 
- 8) To select LAN drivers from those loaded into the BRGEN program, use the Up- and Down-arrow keys to highlight a driver in the "Available LAN Drivers" window and press <Enter>. The driver you selected will appear in the "Selected LAN Drivers" window, and the "LAN Driver Options" window will reappear on the screen.

Note that LAN A cannot be selected as a *remote* communication driver; LAN A must be reserved for a local network interface board.

- 9) To select additional drivers, highlight the "Select Loaded Item" option and press <Enter>. The "Available LAN Drivers" window will reappear on the screen.

- 10) Highlight the appropriate LAN driver and press < Enter >. Repeat this procedure until all the LAN drivers you need appear in the "Selected LAN Drivers" window.
- 11) To delete one of your selections, highlight the "Deselect an Item" option and press < Enter >. The selection bar will move to the "Selected LAN Driver" window. Using the arrow keys, highlight the driver you want to delete and press < Enter >. The driver will disappear from the window.
- 12) To save your selections, press < Escape >. The program will save your selections, and the "Available Options" menu will reappear on the screen. Once options have been saved, the BRGEN utility automatically uses the lowest available configuration option number for each of the selected drivers.

## **ASSIGNING NETWORK ADDRESSES**

- 13) To assign network addresses to each of the LAN drivers you have selected, highlight "Save Selections and Continue" in the "Available Options" menu, and press < Enter >.

A window similar to the one below will appear on the screen.

Bridge Configuration V2.0 Tuesday February 7, 1989 2:22 pm

Sele  
Save

**Network Information**

A: NetWare RX-Net  
Network Address:

B: NetWare Ethernet NE-1000  
Network Address:

C: IBM ASYNC (COM1/COM2)  
Network Address:  
Communication Buffers: 40

Use the arrow keys to highlight the desired field, then type in the desired data. Press the ESCAPE key to save selections and continue.

A network address is a hexadecimal number that identifies the network, much like a house number identifies a particular house. When two or more remote internetworks are connected, they become one internetwork. If network addresses or file server names conflict, unexpected results may occur. To prevent this problem, a system supervisor should coordinate the assigning of network addresses and file server names.

The space next to "Network Address:" for LAN A will be highlighted.

- 14) Type the network address for the specified LAN and press < Enter >. The highlighted area will move to the space next to "Network Address:" for the next LAN board you selected.

Repeat this step until you have assigned the network addresses for all the specified LAN boards.

- 15) If you are installing a nondedicated bridge, you will be prompted to enter an address for the "Non-dedicated Bridge DOS Process." Follow the same rules for entering this address as you would for entering the address of a LAN interface board. The address must be different from the address for any LAN interface board or any network on an internetwork.

## **SPECIFYING COMMUNICATION BUFFERS**

After you have specified network addresses for all the LAN boards you have selected, the space next to "Communication Buffers" will be highlighted. This entry allows you to specify the number of communication buffers you want reserved in the bridge's memory.

Communication buffers are areas in memory that are set aside temporarily to hold arriving network packets. These packets are held until the bridge is ready to process them and send them to their destination.

The default number of communication buffers is 40, although you can specify between 10 and 150 communication buffers.

- 16) To accept the default number of communication buffers, press <Enter>. To specify a different number, use the Backspace key to erase the default setting. Then type in the new number and press <Enter>.
- 17) To save your selections, press <Escape>.



## VIEWING DRIVER CONFIGURATIONS

After you press the Escape key, a window similar to the following will appear on the screen:

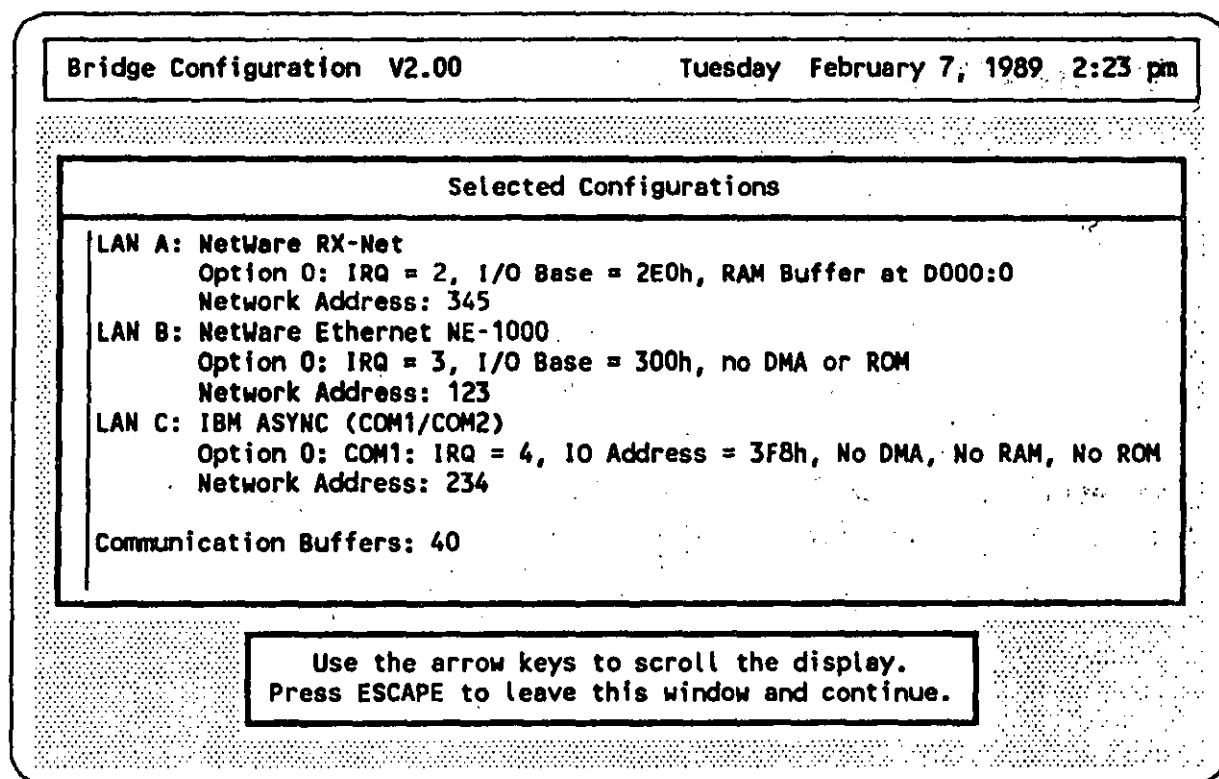

Record the selected configurations, using the "Record of Configuration Settings" chart on page 2-18. You will need to know the selected interrupt and address settings when you install the network interface boards.

- 18) After viewing the selected configurations, press <Escape>. The following confirmation box will appear on the screen:

Continue Bridge Generation Using Selected Configurations?

No

Yes

- 19) To keep the selected driver configurations, highlight "Yes" and press < Enter >. Skip to "Generating the Bridge Software" on page 2-15.

To delete the automatic configurations and select your own, highlight "No" and press < Enter >. The following confirmation box will appear:

**ABANDON BRIDGE GENERATION and Exit!**

No

Yes

- 20) If you want to abandon the bridge generation process, highlight "Yes" and press < Enter >. The "Bridge Generation Options" window will reappear. From there, you can select another LAN driver or exit the BRGEN utility.

To manually select your driver configurations, highlight "No" and press < Enter >. The "Available Options" menu will reappear with an additional option, "Configure Drivers / Resources." Highlight this option and press < Enter >. The following menu will appear:

Configure Drivers / Resources

Review Selected Configurations

Set Network Addresses

Release LAN Configurations

- 21) Highlight "Release LAN Configurations" and press < Enter >. The "Configured LAN Drivers" window will appear, containing the names of the drivers you selected earlier in the bridge generation process.

**SELECTING A DRIVER CONFIGURATION MANUALLY**

- 22) To select a driver configuration manually, highlight the driver that you want to reconfigure (listed in the "Configured LAN Drivers" window) and press < Enter >.

The "Configure Drivers / Resources" window will reappear on your screen with a new option, "Choose LAN Configurations."

- 23) Highlight this option and press < Enter >.

The "Unconfigured LAN Drivers" window will appear on the screen, containing the name of the driver you want to reconfigure.

- 24) Highlight the driver and press < Enter >.

The "Available LAN Configurations" window will appear on the screen. This window will contain a list of available driver configurations:

- 25) Highlight the appropriate configuration and press < Enter >.

The "Configure Drivers / Resources" window will reappear on the screen.

- 26) To view the selected configurations, highlight "Review Selected Configurations" and press < Enter >. The "Selected Configurations" window, containing the LAN driver configurations you selected, will reappear on the screen.

To manually select another driver configuration, press < Escape >. The "Configure Drivers / Resources" window will reappear. Repeat Steps 21 through 25.

- 27) When you have selected all the drivers you need, press < Escape > to continue the bridge generation process. The "Available Options" menu will reappear on the screen.

## **SAVING THE SELECTED CONFIGURATIONS**

- 28) To save the selected configurations, highlight "Save Selections and Continue" in the "Available Options" menu and press < Enter >. The "Selected Configurations" window will reappear. Press < Escape > and the following confirmation box will appear on the screen:

Continue Bridge Generation Using Selected Configurations?

No  
Yes

- 29) Highlight "Yes" and press < Enter >.

## **GENERATING THE BRIDGE SOFTWARE**

After you have assigned network addresses and have specified the driver configurations, the BRGEN utility will generate the bridge software. A message similar to the following will appear on the screen:

```
Novell Linker, Version 2.0  
Linking BRGEN-x: BRIDGE.EXE
```

After a moment, another message will appear on the screen:

```
Configuring BRGEN-x:BRIDGE
```

When the BRGEN utility has configured the bridge software, the message "Valid Bridge 'BRGEN-x:BRIDGE' Exists" will appear on the screen, along with the "Bridge Generation Options" menu.

**EXITING THE BRGEN UTILITY**

- 30) Highlight "Exit BRGEN" in the "Bridge Generation Options" window and press <Enter>.

The following window will appear on the screen:

Exit BRGEN

Yes

No

- 31) Highlight "Yes" if you want to exit the BRGEN utility; then press <Enter>. The DOS prompt will appear on the screen.

Highlight "No" if you do not want to exit the BRGEN utility; then press <Enter>. The "Bridge Generation Options" menu will reappear on the screen.

The BRGEN utility will create the NetWare bridge software file called BRIDGE.EXE.

If you are running BRGEN from a floppy diskette, this file will be on the *BRGEN-3* (5.25-inch format) or the *BRGEN-2* (3.5-inch format) diskette. If you are running BRGEN from a hard disk or network drive, this file will be in the *BRGEN-3* (5.25-inch format) or *BRGEN-2* (3.5-inch format) subdirectory.

- 32) To confirm that the file has been created, insert the appropriate diskette or move to the appropriate directory (*BRGEN-3* or *BRGEN-2*) and type

DIR <Enter>

The file BRIDGE.EXE should appear in the directory list.

To help preserve your bridge software, we recommend you make one or more copies of the BRIDGE.EXE file, and store the original in a safe place.

To configure the bridge for a remote LAN or a remote workstation connection, continue with Chapter 3, "Configuring the Bridge Software for a Remote Connection."

If you are not configuring the bridge for a remote LAN or a remote workstation, continue with the next section.

## **PREPARING A BRIDGE BOOT DISKETTE**

After the bridge is installed, the BRIDGE.EXE file must be loaded into the bridge each time it is booted. To prepare a bridge boot diskette for booting the bridge, complete the following steps.

- 1) Insert a DOS diskette into drive A of a workstation and boot the workstation.
- 2) Insert a blank diskette into drive B and type

`FORMAT B: /S <Enter>`

This command will format the blank diskette and copy the DOS system files onto the diskette. (If you have only one floppy disk drive, you will be prompted to switch diskettes.)

- 3) Use the DOS COPY or the NetWare NCOPY command to copy the BRIDGE.EXE file from the *BRGEN-2* or *BRGEN-3* diskette or subdirectory to the newly formatted diskette in drive A.
- 4) If you are installing a protected-mode bridge, you must copy the CONSOLE.COM file from the *BRUTILS* diskette onto the bridge boot diskette.

## **RECORD OF CONFIGURATION SETTINGS**

Because you will need to know the selected interrupt and address settings for each LAN board when you install the bridge hardware, we suggest you record the settings you have made with the BRGEN utility on the chart below.

**LAN A:**

---

**LAN B:**

---

**LAN C:**

---

**LAN D:**

---

**Nondedicated Bridge DOS Process  
Network Address:**

---

**Buffers:**

---

# **3 CONFIGURING THE BRIDGE SOFTWARE FOR A REMOTE CONNECTION**

---

You are now ready to configure the bridge software you will use to connect your network to a remote LAN or a remote workstation. (If you are installing a local bridge, skip to Chapter 4, "Installing the Hardware.")

In this chapter, you will do the following:

- Use the ARCONFIG utility to specify the configuration settings for the particular type of remote communication board you are using.
- Save the configuration settings.

## **STARTING ARCONFIG (FLOPPY DISK METHOD)**

To run ARCONFIG using floppy diskettes, you will need the *BRUTILS* diskette and the *BRGEN-2* (3.5-inch format) or the *BRGEN-3* (5.25-inch format) diskette.

- 1) Insert the *BRUTILS* diskette into drive A. If your computer has two floppy drives, insert the *BRGEN-2* (3.5-inch format) or the *BRGEN-3* (5.25-inch format) diskette into drive B. If you have only one floppy drive, you will be prompted to swap diskettes.
- 2) If you are using 3.5-inch format diskettes, type the following at the DOS prompt:

```
ARCONFIG BRGEN-2:BRIDGE.EXE <Enter>
```

If you are using 5.25-inch format diskettes, type the following at the DOS prompt:

```
ARCONFIG BRGEN-3:BRIDGE.EXE <Enter>
```



## NetWare External Bridges Supplement

A screen heading similar to the following will appear on the workstation screen

```
Remote Configuration Utility V1.00 Monday, April 3, 1989 2:01 pm
Configuring File BRIDGE.EXE
```

A "Please Wait" message will appear on the screen during the several seconds it takes to load the bridge file onto the computer.

Continue with the instructions under "Specifying Configuration Settings" on page 3-3.

## **STARTING ARCONFIG (HARD DISK OR NETWORK DRIVE METHOD)**

If you want to run the bridge software utilities from a hard disk drive or from the network, you should have copied the utilities from the floppy diskettes they are shipped on to a hard disk or a network drive. (See the instructions in Appendix C.)

- 1) Make sure you are in the work directory you created on the hard disk or network. (See Appendix C.)
- 2) Type the ARCONFIG command exactly as shown, depending on the type of NetWare diskettes you copied the files from.

- If you used 3.5-inch format diskettes to copy the files to your work directory, type the following at the DOS command line:

```
BRUTILS\ARCONFIG BRGEN-2:BRIDGE.EXE < Enter >
```

- If you used 5.25-inch format diskettes to copy the files to your work directory, type the following at the DOS command line:

```
BRUTILS\ARCONFIG BRGEN-3:BRIDGE.EXE < Enter >
```

A heading similar to the following will appear on the workstation screen:

```
Remote Configuration Utility V1.00 Tuesday May 2, 1989 2:01 pm
Configuring File BRIDGE.EXE
```

A "Please Wait" message will appear on the screen during the several seconds it takes to load the bridge file onto the computer.

## **SPECIFYING CONFIGURATION SETTINGS**

To configure the software for your bridge, complete the following steps.

- 1) If you specified more than one remote communication driver when configuring the bridge software, the first prompt that will appear on the screen will be similar to the following:

```
Select LAN Driver
```

```
LAN A
LAN B
LAN C
```

Using the Up- and Down-arrow keys, highlight a LAN driver from the "Select LAN Driver" window and press < Enter >. The "Main Menu" (shown below) will appear on the screen.

If you specified only one communication driver, this menu will automatically appear:

```
Main Menu
```

```
Configure Bridge Server
Configure a Particular Line
```

You must configure the bridge server and each line for all remote communication drivers you selected during the bridge generation process.

- 2) To configure the bridge, highlight "Configure Bridge Server" and press < Enter >.

**EDITING BRIDGE OPTIONS**

After you select "Configure Bridge Server," the "Edit Bridge" window will appear. This window contains information similar to the following:

|                                    |  |                                  |  |
|------------------------------------|--|----------------------------------|--|
| Remote Configuration Utility V1.00 |  | Tuesday February 7, 1989 2:49 pm |  |
| Configuring File                   |  | BRIDGE.EXE                       |  |

| Edit Bridge           |       |
|-----------------------|-------|
| Number of lines       | 1     |
| LAN Driver            | LAN C |
| Name Of Bridge Server |       |
| ID String             |       |
| Control Password      |       |

The "Number of lines" option will show 4 if you are using a WNIM board. If you have a COM1/COM2 or an X.25 board, the option will show 1.

The "LAN Driver" option lists the driver you are configuring.

Each of the remaining items in this window may be edited by highlighting the line and typing an appropriate response. Specific instructions and an explanation of each option are provided in the steps below in the order the options appear on the screen.

To edit the remaining options, follow these steps.

- 1) Highlight the "Name of Bridge Server" option. Then type the name of your remote bridge server (a maximum of 45 characters) and press < Enter >. We suggest using your company name and location so the bridge will be easily identifiable, for example, NOVELL\_PROVO. (Spaces may not be used. You may, however, use the underline character as shown in the example.)
- 2) After you have identified your bridge server, the selection bar will highlight the "ID String" option. To specify the ID string, type up to nine characters and press < Enter >.

The ID string is an optional security feature; however, we recommend that you specify an ID string to control access to your network. The remote workstation shell or remote bridge you will create later must use the exact ID string you enter here in the bridge software (BRIDGE.EXE); otherwise, the remote location will not be able to establish a connection with the bridge.

---

**IMPORTANT:**

You must use the same combination of upper- and lower-case characters for both the remote workstation or bridge and file server ID strings, or the remote workstation will not be able to connect to the file server or bridge. For example, "ABC" and "abc" are not recognized as the same string.

---

If you do not specify an ID string in the bridge software, you must not specify an ID string in the remote shell or remote bridge.

**NetWare External Bridges Supplement**

---

- 3) To specify a control password, type in a password of your choice and press < Enter > .

The control password is also an optional security feature, but we recommend that you use it to control access to your network. The control password, which is used when running the LCONSOLE utility, allows you to establish or terminate connections. As with the ID string, if you specify a control password using lower-case letters while configuring the bridge, you must also use lower-case characters when running the LCONSOLE utility.

- 4) To save the bridge configurations, press < Escape > . You will be prompted:

Save Changes

No

Yes

Answer "Yes" to confirm or "No" to reject the configuration you have set and press < Enter > . The screen will return to the "Main Menu" window.

## **EDITING THE LINE**

After setting the bridge configuration, you are ready to configure a particular line. Most boards have only one line, but if you are installing a WNIM board, you will need to follow these instructions for each of the four lines.

- 1) To edit a line, highlight "Configure a Particular Line" in the "Main Menu" and press < Enter >.

If you are installing a WNIM board, a "Select Line" window similar to the following will appear on the screen:

Select Line

Line 1

Line 2

Line 3

Line 4

Highlight the line number you want to configure and press < Enter >. The "Edit Line" window will appear on the screen.

If you are installing a COM1/COM2 board or an X.25 board, only the "Edit Line" window will appear on the screen.

**NetWare External Bridges Supplement**

The "Edit Line" window will contain information similar to the following:

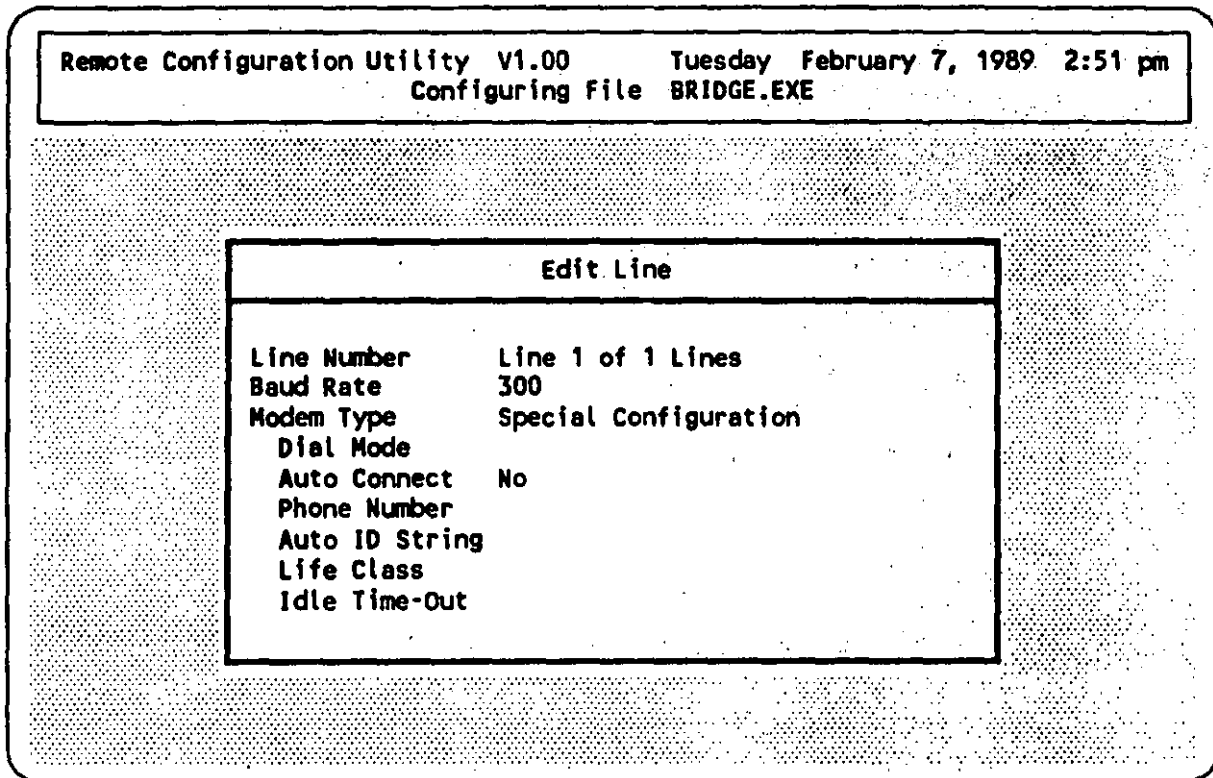

As with the previous windows, each option in the above window can be specified or changed. You have already selected the line number (if applicable).

- 2) To edit the baud rate for the modem at the bridge end of the connection, highlight "Baud Rate" in the "Edit Line" window and press < Enter >. A new window will appear containing the valid baud rates for remote connection: 300, 600, 1200, 1800, 2000, 2400, 3600, 4800, 7200, 9600, or 19200. (The recommended baud rates for your modem are listed in the manual that came with it.)

If you are using a Hayes or compatible modem at the bridge end of the connection, set the baud rate to the highest baud rate the modem will support.

If you are using a modem other than a Hayes or compatible at the bridge, set the baud rate to the highest common denominator of the modems you are using. For example, suppose you have three modems, none of them a Hayes or compatible. The first modem at the bridge will support a maximum baud rate of 2400, the second a maximum of 1200, and the third a maximum of 300. The baud rate at the bridge must be set at 300, the highest common denominator of the three.

---

**NOTE:**

If you are using COM1/COM2 boards in a nondedicated external bridge, you **must** use a baud rate of 2400 or less. NetWare Remote with COM1/COM2 boards will not function in a nondedicated bridge at a baud rate greater than 2400. If you want to use a baud rate greater than 2400, you must use a dedicated external bridge.

---

When you have decided which baud rate you need, highlight that rate and press < Enter >. The "Edit Line" window will reappear, displaying the new baud rate you have selected.

- 3) To edit the modem type, highlight "Modem Type" in the "Edit Line" window and press < Enter >. The following prompt will appear:

Modem Type

Hayes Compatible

Special Configuration

If your modem is a Hayes or compatible, you can select either option.

If your modem is not a Hayes or compatible, you must select the "Special Configuration" option.



## ***NetWare External Bridges Supplement***

---

The "Special Configuration" option is an all-purpose option that allows you to use almost any modem, including a Hayes or compatible. However, the NetWare software will not set anything but the baud rate.

All answering and connecting to incoming calls must be handled through some other means.

The "Special Configuration" option also allows you to use a remote connection in more diverse ways. For example, this option allows you to use a Hayes or compatible with a leased line, a satellite transceiver system, or any hardware that stays in a communication-ready state at all times.

- 4) Select the appropriate option and press < Enter >. When the "Edit Line" window reappears, the new modem type will be displayed.
- 5) To edit the "Auto Connect" option, highlight the option in the "Edit Line" window and press < Enter >.
- 6) Select "Yes" by pressing "Y" and < Enter >, or "No" by pressing "N" and < Enter >.

If you select "No," you will have to manually instruct the bridge to establish a connection to a remote target. You are finished with the line configuration process. Skip to "Saving the Configuration Settings" on page 3-13.

If you select "Yes," the bridge will immediately establish a connection with a remote workstation or bridge when it is booted.

If you select "Yes" but are using the "Special Configuration" option, you do not need to select a phone type or enter a phone number. Skip to Step 10.

If you select "Yes" and are using the "Hayes Compatible" option and you are setting up an automatic connection, you must now select your phone type.

- 7) To select the phone type, highlight "Dial Mode" in the "Edit Line" window and press < Enter >. The following prompt will appear on your screen:

Dial Mode

Pulse

Touch Tone

- 8) Highlight the appropriate phone type and press < Enter >. Your selection will appear in the "Edit Line" window.

After you have selected the appropriate phone type, you must specify the phone number of the remote location the modem will be calling.

- 9) Highlight "Phone Number" in the "Edit Line" window. The prompt provides part of the command string for the "Phone Number" option. (The characters in the command string depend on the baud rate you have selected. You may not edit these characters.)

A) If you are dialing an outside number from a PBX (Private Branch Exchange) telephone system, the outside number should be preceded by the outside line access number (usually 9). The outside line access number should be followed by a comma, which provides a two-second pause in the dialing sequence.

B) Type the remainder of the command string (including the phone number of the bridge you want to call and any other characters specified by the modem documentation), and press < Enter >.

- 10) To add an "Auto ID String," highlight the option in the "Edit Line" window, type the ID string for the remote bridge or workstation, and press < Enter >. Remember, the auto ID string must match exactly the ID string specified for the remote bridge (including upper- or lower-case letters).

11) To determine if the connection you have will be continuous or timed, do the following:

A) Highlight "Life Class" and press < Enter >. The following prompt will appear:

Life Class

Continuous

Timed

B) Highlight your choice and press < Enter >.

If you have a direct connect line or leased telephone line, you will generally select the continuous connection.

If you selected continuous, you are now finished with the "Edit Line" window. Continue with "Saving the Configuration Settings" on the following page.

If you selected the "Timed" option, you must edit the "Idle Time-Out" option. You will need to specify the number of minutes you want the bridge to wait after the last packet has been sent before it automatically terminates a connection.

12) Highlight "Idle Time-Out." Type the number of minutes you have chosen and press < Enter >.

## **SAVING THE CONFIGURATION SETTINGS**

- 1) To save your configuration settings, press <Escape>. The following prompt will appear:

**Save Changes**

Yes

No

- 2) Highlight "Yes" and press <Enter> to save your selected configuration settings.

If you do not want to save the configuration settings, highlight "No" and press <Enter>.

You have now completed the "Edit Line" configuration for one line.

If you are using a WNIM board, you must select a configuration for each line. Repeat Steps 1 through 12 (beginning on page 3-7) for each line.

- 3) If you are using more than one remote driver, you must repeat this process, beginning with "Specifying Configuration Settings" (on page 3-3) for each additional driver.
- 4) After you have configured all lines for the selected driver and have saved the configuration settings, press <Escape>. The following message will appear:

Generating file checksum... please wait

If you are using more than one remote driver, you must repeat this process, beginning with "Specifying Configuration Settings" (on page 3-3) for each additional driver.

You will be returned to the DOS prompt. The configured BRIDGE.EXE file will be placed on the *BRGEN-2* (3.5-inch format) or *BRGEN-3* (5.25-inch format) diskette or subdirectory.

## PREPARING A BRIDGE BOOT DISKETTE

After the bridge is installed, the configured BRIDGE.EXE file must be loaded into the bridge each time it is booted. To prepare a bridge boot diskette for booting the bridge, complete the following steps.

- 1) Insert a DOS diskette into drive A of a workstation and boot the workstation.
- 2) Insert a blank diskette into drive B and type

FORMAT B: /S <Enter>

This command will format the blank diskette and copy the DOS system files onto the diskette. (If you have only one floppy disk drive, you will be prompted to switch diskettes.)

- 3) Use the DOS COPY or the NetWare NCOPY command to copy the BRIDGE.EXE file from the *BRGEN-2* or *BRGEN-3* diskette or subdirectory to the newly formatted diskette in drive A.
- 4) If you are installing a protected-mode bridge, you must copy the CONSOLE.COM file from the *BRUTILS* diskette onto the bridge boot diskette.

If you need to install the bridge hardware, continue with Chapter 4, "Installing the Hardware."

If the bridge hardware is already installed, skip to Chapter 5, "Operating the Bridge."



**MANTENIMIENTO GENERAL  
DE LA RED**

NOVELL, INC.

100-000506-001

177 EAST

1700 SOUTH

PROVO, UTAH

84601

(801) 379-5900

(800) 453-1267

MADE IN U.S.A.

COMMAND

LINE

UTILITIES

QUICK

REFERENCE



NOVELL

NetWare

## COMMAND LINE UTILITIES GROUPINGS

Here, the NetWare command line utilities are grouped according to function. The command line utility used to perform each task is given. For the page on which the task is explained, see the alphabetical listing.



### LOGGING IN AND OUT

- LOGIN** *[server]{user[option ...]}*  
Log in to a file server.
- ATTACH** *[server]{user}*  
Log in to additional file servers.
- SETPASS** *[server]*  
Create or change a user password.
- LOGOUT** *[server]*  
Log out of a file server.



### MAPPING DRIVES

- MAP**  
There are a variety of command formats for this utility. Consult the *NetWare Command Line Utilities* manual for detailed information.  
Assign network drives to directories and view the list of such assignments. Also delete drive mappings.



## NETWORK SECURITY

- FLAG** *[path | filespec [option ...]]*  
View or change file attributes (file security).
- FLAGDIR** *[path [option ...]]*  
View or change attributes of subdirectories in a given directory.
- GRANT** *option ... [FOR path] TO [USER] user | [GROUP] group*  
Grant trustee rights to users or groups.
- REMOVE** *[USER] user | [GROUP] group [[FROM] path]*  
Remove users or groups as trustees in a directory.
- REVOKE** *option ... [FOR path] FROM [USER] user | [GROUP] group*  
Revoke individual's or group's trustee rights in a directory.
- RIGHTS** *[path]*  
View your rights in a directory.
- TLIST** *[path [USERS | GROUPS]]*  
View the trustee list of a directory.



## FILE SERVER INFORMATION

- CHKVOL** *[path ...]*  
View how much space a given volume contains, how much space is available to each user, and how much of that space is being used.
- NVER**  
View the version of software running on your file server and workstation.
- SLIST**  
View a list of file servers running on your network.
- SYSTIME** *[server]*  
View a file server's current time and date, and synchronize your workstation's time and date with that of the server.



## DIRECTORY INFORMATION

- LISTDIR** *[path] [option ...]* View the directory structure of a volume, drive, or directory. Also view maximum rights masks and creation dates of subdirectories.
- NDIR** *[path] | [filename]*  
**NDIR** *path | filespec option [...]*  
View information about files and directories.
- RENDIR** *path [TO] directory*  
Rename a directory.





## USER INFORMATION

- USERLIST** [*server*][*user*] [*All*]  
View a list of the users logged in to a file server, along with login information.
- WHOAMI** [*server*] [*option ...*]  
View your username, the file server(s) you are logged in to, your group memberships, your security equivalences, your effective rights in directories on your internetwork, and the date and time of your last login.

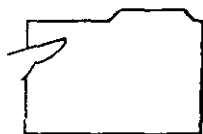

## MANIPULATING FILES

- HOLDOFF** Reverse the effect of the **HOLDON** utility.
- HOLDON** Hold open a network file so it cannot be accessed simultaneously by more than one user.
- NCOPY** *filespec* [**TO**] [*path*] [*filename*] [**Verify**]  
Copy files from one network directory to another.
- SALVAGE** [*path*]  
Recover the last file(s) erased from your workstation.
- PURGE** Permanently delete erased files.
- SMODE** [*path* | *filespec*] [*option*]  
View or set search mode (**SMODE**) settings for data files in a given directory.

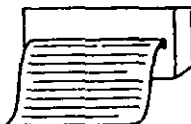

## PRINTING

- NPRINT** *filespec* [*option ...*]  
Print existing files.
- PSTAT** [*option ...*]  
View status of network printers.
- CAPTURE** [*option ...*]  
Save data to a network file or print data on a network printer. Also view status of LPT ports.
- ENDCAP** [*option ...*]  
End the capture of one or more of your workstation's LPT ports.



## SENDING MESSAGES

- SEND** "message" [**TO**] [**USER**] [*server*/*user ...*]
- SEND** "message" [**TO**] [**GROUP**] [*server*/*group ...*]
- SEND** "message" [**TO**] [**USER**] [*server*/*user ...*] [**GROUP**] [*server*/*group ...*]  
Send messages to other network stations.
- CASTOFF** [**All**] Prevent messages from other workstations or prevent messages from workstations and the file server console from reaching your workstation.
- CASTON** Allow messages from other workstations and the file server console to reach your workstation.

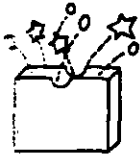

## MISCELLANEOUS

**SETTTS** *[logical level [physical level]]*  
Determine how many record locks TTS will ignore before tracking a transaction.

**NSNIPES** *[option]*

**NCSNIPES** *[option]*

Play a network game.

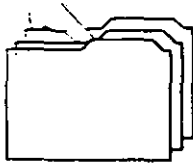

## ARCHIVING AND RESTORING FILES

**LARCHIVE** *[path | SYSTEM]*

Archive network files to local floppy diskettes or to hard disks.

**LRESTORE** Restore network files that were archived onto local disks using **LARCHIVE**.

**NARCHIVE** *[path | SYSTEM]*

Archive network files to network disks.

**NRESTORE** Restore network files that were archived network disks using **NARCHIVE**.

## NETWARE COMMAND LINE UTILITIES (ALPHABETICAL)

The NetWare command line utilities are listed below. Each utility is referenced to its associated command grouping (on this card) and to the page(s) in the *NetWare Command Line Utilities* manual that fully explain it.

**ATTACH** Logging In and Out 2-2  
**CAPTURE** Printing 2-5  
**CASTOFF** Sending Messages 2-15  
**CASTON** Sending Messages 2-17  
**CHKVOL** File Server Information 2-18  
**ENDCAP** Printing 2-22  
**FLAG** Network Security 2-25  
**FLAGDIR** Network Security 2-32  
**GRANT** Network Security 2-36  
**HOLDOFF** Manipulating Files 2-41  
**HOLDON** Manipulating Files 2-42  
**LARCHIVE** Archiving and Restoring Files 3-3  
**LISTDIR** Directory Information 2-43  
**LOGIN** Logging In and Out 2-47  
**LOGOUT** Logging In and Out 2-50  
**LRESTORE** Archiving and Restoring Files 3-23  
**MAP** Mapping Drives 2-52  
**NARCHIVE** Archiving and Restoring Files 3-30  
**NCOPY** Manipulating Files 2-58  
**NDIR** Directory Information 2-63  
**NPRINT** Printing 2-78  
**NRESTORE** Archiving and Restoring Files 3-50  
**NSNIPES** Miscellaneous 2-83  
**NVER** File Server Information 2-86  
**PSTAT** Printing 2-87  
**PURGE** Manipulating Files 2-91  
**REMOVE** Network Security 2-92  
**RENDIR** Directory Information 2-95

**REVOKE** Network Security 2-97  
**RIGHTS** Network Security 2-101  
**SALVAGE** Manipulating Files 2-105  
**SEND** Sending Messages 2-107  
**SETPASS** Logging In and Out 2-110  
**SETTTS** Miscellaneous 2-113  
**SLIST** File Server Information 2-116  
**SMODE** Manipulating Files 2-118  
**SYSTIME** File Server Information 2-123  
**TLIST** Network Security 2-124  
**USERLIST** User Information 2-127  
**WHOAMI** User Information 2-131

## NOTES



OVERBURY  
121 AS  
1700 BOUNTY  
ROAD  
1101  
5011 D'A  
8001 433-1287  
MADE IN U.S.A.

100-000-118-001

CONSOLE  
COMMANDS  
QUICK  
REFERENCE

NetWare

  
Copyright 1987, All rights reserved.

## CONSOLE COMMAND GROUPINGS

---

Here, the NetWare console commands are grouped according to function. The full command format is given for each command. (The first part of the command format is the command name.) A brief explanation of the command follows the command format.



### FILE SERVER INFORMATION

---

#### CLEAR STATION *nn*

Disconnects station from file server. *Use with caution!*

#### CONFIG

Lists and displays addresses of file server's network boards.

#### MONITOR [*station number*]

Brings up Monitor Display; this tracks workstation activity.

#### NAME

Displays file server's name.

#### OFF

Clears console screen.



### SWITCHING MODES OF NONDEDICATED FILE SERVER

---

*Only for NetWare 86 or 286 nondedicated file servers.*

#### CONSOLE

Switches nondedicated file server from local DOS to console mode.

#### DOS

Switches nondedicated file server from console to local DOS mode.



## SENDING MESSAGES

---

#### BROADCAST *message*

Sends console messages to *all* stations logged in or attached to server.

#### CLEAR MESSAGE

Clears console screen's message line.

#### SEND "*message*" [TO][STATION][*stationlist*]

Sends console messages to specified stations.



## LOGGING IN

---

#### DISABLE LOGIN

Prevents additional stations from logging in to file server.

#### ENABLE LOGIN

Re-enables station login.



## REMOVABLE VOLUMES

---

*To be used only with Advanced NetWare 86 servers.*

#### DISMOUNT [PACK][*removable volume number*]

Prepares files for exchange of "removable volumes." Used with MOUNT.

#### MOUNT [PACK][*removable volume number*]

Mounts a "removable volume." Used with DISMOUNT.



## PRINTING

---

#### CHANGE FORM TYPE MOUNTED IN PRINTER

P[RINTER] *nn* FORM[MOUNT] *xx*  
Tells file server that printer's paper has been changed.

#### FORM FEED

P[RINTER] *nn* FORM FEED  
Advances paper one page to help in positioning forms.

#### LIST A PRINTER'S QUEUES

P[RINTER] *nn* [Q[UEUE[S]]]  
Lists the queues the printer services.

#### LIST PRINTER STATUS

P[RINTER[S]]  
Lists and gives information about all printers attached to file server.

#### MARK TOP OF FORM

P[RINTER] *nn* MARK [[TOP OF]FORM]  
Prints asterisks to help align continuous-feed, preprinted forms.

#### REWIND PRINTER

P[RINTER] *nn* REWIND *xx* [PAGES]  
Stops printer, backs up specified number of pages, reprints pages.

#### START PRINTER

P[RINTER] *nn* START  
Restarts printer stopped with STOP PRINTER command.

#### STOP PRINTER

P[RINTER] *nn* STOP  
Temporarily stops printer.



## MANAGING PRINT QUEUES AND SPOOLERS

### ADD QUEUE TO PRINTER

**P[RINTER] nn ADD [QUEUE] name [[AT] [PRIORITY] xx**  
 Adds an existing queue to printer.

### CHANGE QUEUE PRIORITY

**Q[UEUE] name C[HANGE][JOB] nn [TO] [PRIORITY] xx**  
 Changes printing order of job within its queue.

### CHANGE SPOOL MAPPINGS

**S[POOL] nn [TO][QUEUE] name**  
 Redirects spool jobs supported by NetWare v2.0a and below to specified queue.

### CREATE NEW PRINT QUEUE

**Q[UEUE] name CREATE**  
 Creates a queue with specified name.

### DELETE ALL JOBS IN QUEUE

**Q[UEUE] name D[EL[ETE]] [JOB]**  
 Deletes jobs currently listed in queue.

### DELETE QUEUE FROM PRINTER

**P[RINTER] nn DEL[ETE][QUEUE] name**  
 Temporarily removes a queue from a printer's service.

### DELETE QUEUE JOB

**Q[UEUE] name D[EL[ETE]] [JOB] xx**  
 Deletes a job from a particular queue.

### DESTROY PRINT QUEUE

**Q[UEUE] name DESTROY**  
 Destroys the named queue.

### LIST ALL PRINT QUEUES

**Q[UEUE[S]]** Lists file server's queues.

### LIST CURRENT SPOOL MAPPINGS

**S[POOL]** Displays file server's spool mappings.

### LIST QUEUE CONTENTS

**Q[UEUE] name [JOB[S]]**  
 Lists all print jobs in printer's queue.



## OTHER COMMANDS

### DISK (for Advanced NetWare)

**DISK** Gives status of all network drives.

### DISK (for SFT NetWare)

**DISK** Gives status of all network drives.

**DISK\*** Indicates physical drive number of each volume on file server.

**DISK volume name**  
 Displays information about specified volume.

**DOWN** Writes cache buffers to disk; shuts down operating system. *Always use before powering off the file server.*

**LOCK** Locks the file server console keyboard.

**REMIRROR nn (for SFT NetWare)**  
 Restores SFT mirroring after one drive in mirrored pair fails or is shut off.

**SETKPASS** Changes the file server console keyboard password.

**UNMIRROR nn (for SFT NetWare)**  
 Shuts down specified drive and turns off its mirroring feature.

**VAP** Lists and gives commands used by all Value Added Processes added to NetWare operating system.

# NETWARE CONSOLE COMMANDS (ALPHABETICAL)

Each NetWare console command is listed below with a reference to its associated command grouping (on this card) and to the page(s) in the *NetWare Console Reference* that fully explain it.

- ADD QUEUE TO PRINTER
  - Managing queues 2-6
- BROADCAST
  - Sending messages 3-2
- CHANGE FORM TYPE MOUNTED
  - IN PRINTER Printing 2-8
- CHANGE QUEUE PRIORITY
  - Managing queues 2-10
- CHANGE SPOOL MAPPING
  - Managing queues 2-12
- CLEAR MESSAGE
  - Sending messages 3-4
- CLEAR STATION
  - File server info 3-5
- CONFIG
  - File server info 3-7
- CONSOLE (DOS command)
  - Switching modes 3-9
- CREATE NEW PRINT QUEUE
  - Managing queues 2-14
- DELETE ALL JOBS IN QUEUE
  - Managing queues 2-16
- DELETE QUEUE FROM PRINTER
  - Managing queues 2-18
- DELETE QUEUE JOB
  - Managing queues 2-20
- DESTROY PRINT QUEUE
  - Managing queues 2-21
- DISABLE LOGIN
  - Logging in 3-10
- DISK (for Advanced NetWare)
  - Other commands 3-12
- DISK (for SFT NetWare)
  - Other commands 3-16
- Variation 1: DISK
- Variation 2: DISK\*
- Variation 3: DISK *volume name*
- DISMOUNT
  - Removable vols 3-24
- DOS
  - Switching modes 3-26
- DOWN
  - Other commands 3-27
- ENABLE LOGIN
  - Logging in 3-29

- FORM FEED
  - Printing 2-23
- LIST A PRINTER'S QUEUES
  - Printing 2-24
- LIST ALL PRINT QUEUES
  - Managing queues 2-26
- LIST CURRENT SPOOL MAPPINGS
  - Managing queues 2-28
- LIST PRINTER STATUS
  - Printing 2-29
- LIST QUEUE CONTENTS
  - Managing queues 2-30
- LOCK
  - Other commands A-1
- MARK TOP OF FORM
  - Printing 2-32
- MONITOR
  - File server info 3-30
- MOUNT
  - Removable vols 3-38
- NAME
  - File server info 3-40
- OFF
  - File server info 3-41
- REMIRROR
  - Other commands 3-42
- REWIND PRINTER
  - Printing 2-34
- SEND
  - Sending messages 3-46
- SET TIME
  - File server info 3-48
- SETPASS
  - Other commands A-3
- START PRINTER
  - Printing 2-36
- STOP PRINTER
  - Printing 2-38
- TIME
  - File server info 3-50
- UNMIRROR
  - Other commands 3-51
- VAP
  - Other commands 3-54

# NetWare 386

NetWare 386 es un acontecimiento trascendental dentro de las redes de computación, un importante logro del líder de la industria de redes. Diseñado para tomar ventaja de todas las potencialidades del procesador 80386, NetWare 386 ofrece nuevos niveles de rendimiento y funcionalidad en las redes de equipos de cómputo.

Con su flexible arquitectura permite unidades de almacenamiento magnético de hasta 32 Terabytes y 250 usuarios simultáneos. NetWare 386 ayuda a la integración y administración de diferentes sistemas en el acceso a poderosas aplicaciones basadas en servidores de archivos, en el mantenimiento de complicadas bases de datos e información vital, contando con los mismos servicios que las computadoras principales y las microcomputadoras a un costo significativamente menor.

Novell respalda al NetWare 386 con la experiencia que ha hecho a NetWare el estándar de la industria. NetWare 386 es la séptima generación de sistemas operativos de red, siendo estos productos actualmente utilizados por más de 400,000 Servidores de Archivos en todo el mundo. Ahora en su versión 386, NetWare se ha convertido en la plataforma de redes de cómputo de los noventas.

Mientras que la velocidad y la potencia son dos elementos cruciales en una red, NetWare 386 ofrece un tercer elemento, confiabilidad. Novell sabe que es fundamental además mantener el sistema en perfecto funcionamiento; la información con exactitud y el costo al menor nivel posible. NetWare 386 tiene la misma confiabilidad que ha hecho a NetWare el sistema operativo de redes más utilizado del mundo, para esto, se incluyen características de seguridad tales como HOT FIX, Sistema de Monitoreo de Transacciones (TTS), espejo de discos y duplicidad de discos.

NetWare 386 da un paso adelante creando un campo de seguridad para proteger su información. Claves de acceso encriptadas en el cable que evitan a cualquier intruso tener acceso al sistema. Las asignaciones ahora mejoradas de derechos sobre archivos y directorios, permiten determinar quién tiene acceso a los servicios de la red, asegurando que sólo el supervisor tenga acceso para adicionar aplicaciones en el servidor.

La arquitectura abierta del NetWare 386 permite a los desarrolladores unir una nueva generación de aplicaciones directamente a la velocidad y potencia del sistema operativo. Las interfaces para programas de aplicación (APIs) le proporcionan a los desarrolladores las herramientas necesarias para crear aplicaciones basadas en servidores de archivos que aumentan el poder de la red. La Interface OPEN DATA-LINK le permite a los desarrolladores de adaptadores de LAN y de protocolos el acceso al corazón de la arquitectura del NetWare 386 mediante una interfase estándar.

NetWare 386 a diferencia de otros sistemas operativos de red permite libertad de elección, permite desde la elección de aplicaciones hasta el HARDWARE que resulte más conveniente. Toda vez que se hayan hecho las elecciones correspondientes, NetWare conjunta todos los recursos de una manera fácil, automática y confiable, con fundamento en una total independencia a los protocolos.

NetWare 386 se une al PORTABLE NETWARE para formar el cimiento de los sistemas abiertos bajo NetWare, un importante paso en la evolución de la tecnología de redes. Los sistemas abiertos de NetWare extienden el poder de las redes más allá de los grupos de redes locales para incluir todos los recursos de computación.

## CARACTERÍSTICAS

Una plataforma de alto rendimiento para aplicaciones de alto rendimiento.

NetWare 386 utiliza todas las ventajas del ambiente de 32 bits del microprocesador 80386. Este procesador manipula información y ejecuta instrucciones a una velocidad mayor que la de cualquier producto de su tipo. NetWare 386 utiliza esta velocidad y poder, para soportar aplicaciones de alto rendimiento. Con el advenimiento próximo del 80486, NetWare 386 desarrollará aún más velocidad y potencia en las máquinas que utilicen este procesador.

Más de 5,000 aplicaciones ofrecidas por más de 2,000 proveedores de SOFTWARE son utilizadas por usuarios de NetWare. Como sistema operativo especializado en redes, NetWare 386 está igualmente

optimizado para soportar aplicaciones de servidores de archivos tipo BACK-END. Por ejemplo, cuando se agrega un mecanismo de base de datos al NetWare 386, el mecanismo BACK-END procesa los requerimientos sobre la base de datos misma en lugar de enviar toda la base de datos a la estación para procesamiento. Esto reduce el tráfico sobre la red que a su vez, permite el acceso a la información de una manera más expedita.

Con NetWare 386, ahora más usuarios pueden tomar ventaja de las aplicaciones y datos almacenados en el servidor de archivos. NetWare 386 soporta hasta 250 usuarios simultáneos. En función de que NetWare 386 es totalmente compatible con las versiones anteriores de NetWare, se pueden integrar redes 386 sin ningún esfuerzo dentro de las redes ya existentes. La mayoría de las aplicaciones seguirán funcionando sin ninguna modificación.

**Arquitectura Flexible.** Satisfaciendo las necesidades de comunicación de hoy y mañana.

La flexible arquitectura del NetWare 386 permite que elementos adicionales de SOFTWARE sean adicionados a la red mientras el servidor esta funcionando normalmente.

Igualmente, es posible tanto para Novell como para los diseñadores de SOFTWARE independientes, diseñar módulos de programación que se unan dinámicamente al NetWare 386, permitiendo con ello una mayor funcionalidad de la red. DRIVERS basados en servidores de archivos, utilerías y aplicaciones pueden ser cargadas en el servidor de la red conforme a los requerimientos. Dado que estos módulos de programas son dinámicamente incorporados y desincorporados, son referidos como NetWare LOADABLE MODULES (NLMs).

INSTALL, una utilería incluida dentro del producto, ayuda a efectuar la instalación de la red en solo unos minutos. Toda vez que la red esta instalada, los NLMs simplificarán las tareas de administración, permitiendo la expansión del sistema sin tener que apagar e inicializar el servidor de archivos.

Adicionalmente, los NLMs utilizan los beneficios de la asignación dinámica de

calculará los recursos necesarios para una ejecución óptima.

*La arquitectura modular expandible del NetWare 386 provee una plataforma abierta para el desarrollo de aplicaciones.*

**Plataforma abierta para desarrollo de aplicaciones, adaptadores y protocolos.**

El diseño modular del NetWare 386 ofrece una plataforma abierta para desarrolladores independientes de software.

Las interfaces para programas de aplicación (APIs) extienden la velocidad y el poder a la comunidad desarrolladora de software. En adición a las APIs, Novell provee a los desarrolladores de una librería ANSI C y el compilador C NETWORK COMPILER/386, incluyendo un LINKER y un SYMBOLIC DEBBUGER, con el objeto de permitir el desarrollo de nuevas aplicaciones. Novell, igualmente provee KITS de desarrollo de DRIVERS de red y DRIVERS de disco para ayudar a los desarrolladores a escribir DRIVERS de servidor 386.

La interfase OPEN DATA-LINK es soportada por el NetWare 386 y sus especificaciones están abiertas a la comunidad desarrolladora. OPEN DATA-LINK es una interfase estándar que permite que multiples protocolos compartan un adaptador de red simultáneamente.

*La Interfase OPEN DATA-LINK proporciona una interfase estándar para adaptadores de red y desarrollo de protocolos.*

**Un sistema confiable.**

NetWare 386 proporciona todas las características de seguridad con que actualmente cuenta el SFT nivel II, con el objeto de asegurar que todos los datos estén siempre disponibles y confiables.

HOT FIX es una característica que protege a los datos de posibles daños en el disco magnético. Si los datos no pueden ser escritos o leídos confiablemente desde un bloque particular del almacenamiento magnético, HOT FIX guarda los datos en una área redireccionada. El sistema operativo marca los bloques malos y estos ya no serán utilizados en el futuro.



**TTS (Sistema de monitoreo de transacciones)** protege las bases de datos ante posibles corrupciones. Si una transacción presenta una falla mientras se efectúa una escritura a la base de datos, la transacción es nulificada y la base de datos es restaurada hasta la última transacción efectuada correctamente. Además de que NetWare 386 permite el monitoreo de hasta 25,000 transacciones simultáneas.

La duplicidad de discos y el espejo de discos también ayudan al resguardo de la información. El espejo de discos duplica la información en dos discos duros bajo el mismo controlador. Si un disco falla, NetWare continúa la operación normal en el disco de soporte. La duplicidad de discos es similar, pero escribe datos en dos discos bajo diferentes controladores para salvaguardar posibles fallas tanto en los medios magnéticos como en sus controladores.

#### **Sólida Seguridad.**

La seguridad del NetWare 386 se ha mejorado con el objeto de asegurar la confidencialidad de la información.

Ahora las claves de acceso se encriptan en el cable transmisor de tal suerte que quedan protegidos desde el momento que se entra a la transacción, mientras que los derechos sobre los directorios permiten el control del acceso a los directorios. Con el NetWare 386, estos derechos de acceso pueden ser asignados a nivel archivo, permitiendo accesos restringidos o abiertos a un mayor nivel.

Otra característica adicional de seguridad incluida, es que todas las aplicaciones cargadas en el servidor, sólo podrán hacerse desde el directorio SYS:SYSTEM. En función de que sólo el supervisor está debidamente autorizado para hacer esto, nadie más que él podrá adicionar aplicaciones en el servidor. El supervisor puede igualmente cargar MONITOR, una utilidad incluida en el NetWare 386 que cierra el teclado de la consola hasta que una clave de acceso sea introducida.

**Sistema de archivos mejorado.** Guardando más información y accediendo más rápido.

NetWare 386 ofrece hasta 32 TB (32 Billones) de almacenamiento en disco. Los volúmenes que anteriormente estaban limitados a un solo disco, pueden ahora ampliarse a múltiples discos (hasta 32).

Esto significa que el servidor de archivos puede almacenar grandes bases de datos y aplicaciones que anteriormente sólo podían ser guardadas en minicomputadoras o computadoras principales.

Con su flexible arquitectura, NetWare 386 permite adicionar más volúmenes o adicionar almacenamiento a los volúmenes actuales, mientras el servidor sigue en funcionamiento. Los archivos pueden ser ahora hasta de 4 GB (4 Millones).

Dado que los segmentos de un archivo son automáticamente escritos en diferentes unidades de disco duro y estos segmentos pueden ser accedidos y escritos simultáneamente, los archivos pueden ser accedidos y modificados aún con mayor rapidez.

El sistema de archivos permite una estructura que evita el desperdicio de espacio en disco. En lugar de escribir un archivo en una cantidad predeterminada de espacio en disco, llenando la parte no usada de caracteres nulos, el file server asigna tan sólo el espacio en disco que el archivo necesita. NetWare 386 también permite rescatar los archivos borrados más fácilmente. Como una característica adicional, el sistema de archivos conserva todos los archivos borrados hasta que el servidor utiliza todo el espacio de disco disponible o cuando se borren deliberadamente del disco.

**Servicios de impresión flexibles para satisfacer demandas variadas de impresión.**

Los mejorados servicios de impresión del NetWare 386 proporcionan más opciones de impresión dentro de la red.

Bajo NetWare 386, los servicios de impresión son proporcionados a través de una aplicación del servidor de impresoras, que se cargan dentro del servidor de la red. El servidor de impresoras permite a los usuarios imprimir en red o localmente en cualquier impresora de estaciones de trabajo asignadas como compartidas.

Cada servidor de impresión soporta hasta 16 impresoras. Dado que se pueden cargar varios servidores de impresión en la red, se pueden cargar un número virtualmente ilimitado de impresoras. Estas pueden tener interfases seriales, paralelas o interfases remotas.

Agregar impresoras a las estaciones de trabajo, en vez de agregarlas al servidor de archivos podrá modificar las áreas de tráfico general en áreas de acceso más restringido. Igualmente, la localización de impresoras cercanas a los usuarios incrementará la productividad ya que el tiempo invertido en recoger trabajos de impresión será considerablemente menor.

Los servicios de impresión de NetWare 386 permiten la jerarquización de las colas de impresión a ser servidas. Por ejemplo, se pueden crear colas que den el servicio de impresión en base a un criterio de primeras entradas y primeras salidas o dando prioridad a los trabajos impresos en una forma particular.

**La Plataforma para las Redes en los 90's.**

NetWare 386 es el estándar que soporta todos los otros estándares de la industria.

En el verdadero ambiente de computación de redes, el servidor proporciona un punto de acceso a los grupos de trabajo de redes locales, minicomputadoras o computadoras principales, independientemente de la forma de red, protocolo de comunicación o sistema operativo de la estación de trabajo que se escoja. Con una arquitectura abierta y modular, NetWare 386 está diseñado para redes de cómputo, siendo un paso adelante dentro de los ambientes de cómputo de redes, NetWare 386 es el cimiento para los futuros avances en esta área, incluyendo:

- \*\* Independencia de protocolos. Un mecanismo de protocolos permite el acceso de protocolos múltiples - IPX/SPX, Appletalk, TCP/IP, SNA, NetBEUI, OSI, etc. - que pueden ser cargados y descargados del servidor de la red conforme se vayan necesitando. El usuario escoge los protocolos que satisfacen sus necesidades y NetWare los soportará de una manera transparente.
- \*\* SFT nivel III. Extendiendo las características de confiabilidad del SFT II, SFT nivel III permite el espejo de todo el server de la red. Bajo SFT III, un fallo en el sistema es completamente transparente para los usuarios. Si un servidor falla, el sistema opera-

tivo utilizará el servidor en espejo y los usuarios no percibirán los cambios en la operación del sistema.

- \*\* Servicios distribuidos. Como una parte integral de los sistemas de NetWare abiertos, los servicios distribuidos proveerán las características necesarias para el ámbito de computación en red. Estas características incluyen:
  - 1) Servicios de directorio distribuidos que simplifican la localización de los recursos en la red, ya sean locales o remotos, a través de la base de datos de directorios distribuidos.
  - 2) Administración de sistemas distribuidos que incluye amplios servicios de administración de la red que soportan configuración, rendimiento, aislamiento de fallas, seguridad y contabilidad de recursos.

**Especificaciones Técnicas.**

*Limitaciones de NetWare 386.*

|                                                   |         |
|---------------------------------------------------|---------|
| Usuarios lógicos soportados                       | 250     |
| Archivos abiertos simultáneamente por el servidor | 100,000 |
| Registros de directorios por volumen              | 32,000  |
| Volúmenes por servidor                            | 32      |
| Drives lógicos por volumen                        | 32      |
| Capacidad de Almacenamiento                       | 32TB    |
| Memoria RAM                                       | 4GB     |
| Tamaño de archivo                                 | 4GB     |
| (Puede ocupar varios discos duros).               |         |

**Requerimientos de Hardware**

**Estaciones de trabajo de la red**  
 IBM PC XT, AT o compatibles  
 IBM PS/2 Modelos 25, 30, 50, 50Z, 60, 70 u 80  
 Macintosh II, SE, Plus ó 512 Ke

**Servidores de Red.**  
 ACER 386 ó compatibles  
 Novell 386A, 386AE ó compatibles  
 IBM PS/2 Modelos 70 u 80 ó compatibles

**Adaptadores de red.**  
 Novell Ethernet  
 Novell Arcnet  
 IBM token Ring



**FACULTAD DE INGENIERIA U.N.A.M.  
DIVISION DE EDUCACION CONTINUA**

**INSTALACION Y MANEJO DE REDES (LAN) CON  
NETWARE DE NOVELL (PARTE IIIII)**

**ANEXO A**

**NOVIEMBRE, 1992**

# 10

## PRINTING ON THE NETWORK

---

NetWare allows for great flexibility in printing. This chapter explains the basics of printing on the network. It will begin with a brief explanation of printing on the network. It will also explain the following:

- How to use the default printing settings
- How to customize your network with **PRINTDEF** and **PRINTCON** printing utilities
- How to print with the **PCONSOLE** utility
- How to use the NetWare **NPRINT** and **CAPTURE** commands
- How to print from applications

This chapter also provides information about compatibility with previous NetWare versions.

## NETWORK PRINTING OVERVIEW

NetWare v2.1 and above uses print queues to handle network print jobs.

When a standalone workstation sends a print request to its locally attached printer, the request is sent directly to the printer for processing.

When a network workstation sends a print request to a network printer, the request is placed in a print queue on the file server rather than being sent directly to the printer. The print queue stores the print requests until the printer can service the print request. (See Figure 10.1.)

When the printer is ready to service a request, a print server process sends the request from the queue to the printer that the queue has been assigned to. (The print server process is currently part of the file server. For more information about print servers, see Chapter 8 in the *NetWare Supervisor Reference*.) This queue-to-printer assignment is known as a printer mapping.

### STANDALONE PC

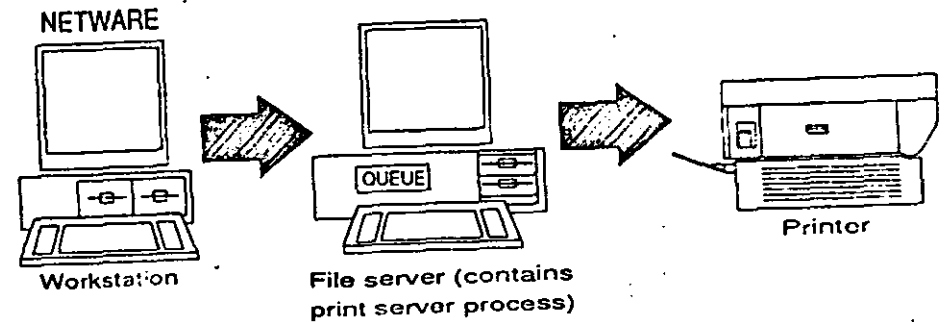
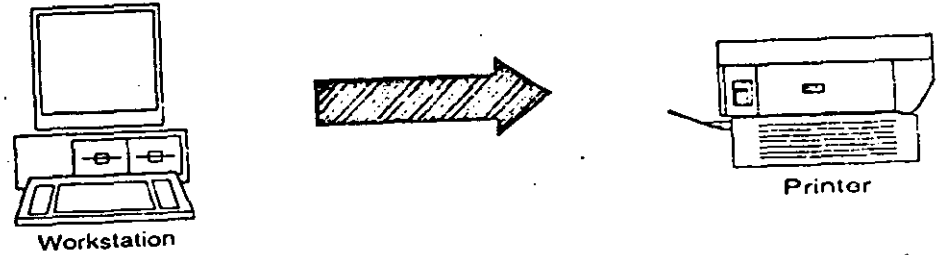

Figure 10.1  
Printing on a Network

NetWare v2.1 and above allows one printer to service more than one queue. For example, you could have two queues, PRINTQ\_0 and PRINTQ\_1, serviced by PRINTER0, as in Figure 10.2. PRINTQ\_0 could be assigned a higher priority level than PRINTQ\_1. Thus, you could put all the rush print jobs in PRINTQ\_0 and they would be printed before any print jobs in PRINTQ\_1.

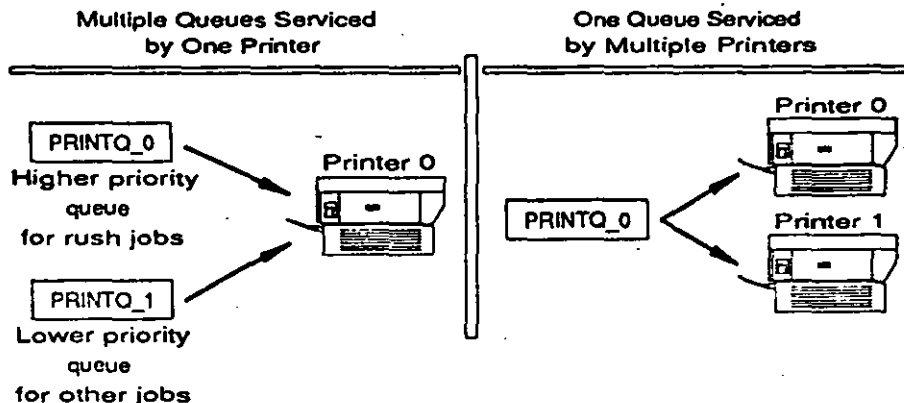

Figure 10.2  
One Printer Servicing Multiple Queues

One queue can also be serviced by more than one printer. For example, if you had a large number of printing requests, you could assign both PRINTER0 and PRINTER1 to print jobs from PRINTQ\_0.

You assign queues to printers using printer mappings. Printer mappings will be explained in "Printer Mappings: Console Commands or AUTOEXEC.SYS" file on page 10-10.

You can also specify which users are allowed to put print jobs in each queue.

## SETTING UP YOUR NETWORK FOR PRINTING

As supervisor, you will be responsible for setting up the printing environment for the network. The next section explains printing with the system default settings. Using these default settings, you can print without having to set up any special options. Read through the default settings as explained in the following section to see if they are appropriate for your printing needs.

Then we will explain how to customize network printing for greater printing flexibility.

## PRINTING USING SYSTEM DEFAULTS

The system defaults are listed below.

- One print queue is created for and assigned to each printer attached to the file server.
- One spooler is created for and assigned to each print queue.
- The group EVERYONE is assigned to each system-created print queue as queue user.
- The user SUPERVISOR is assigned to every system-created print queue as queue operator.
- A default print definition uses parameters set on the printer.

When the file server first comes up, the operating system automatically assigns one print queue to each printer attached to the file server. This makes a one-to-one correspondence or mapping between the print queue(s) and the printer(s).

For example, if you had two printers attached to your file server, the operating system would create PRINTQ\_0 for PRINTER0 and PRINTQ\_1 for PRINTER1. The printer numbers are assigned to printers during installation.

The spooler mappings allow for compatibility with previous NetWare versions and allow the NetWare printing commands to function properly. For more information about spoolers, see "Spooler Mappings" on page 10-9.

In order to send print requests to a queue, a network user must be made a print queue user. When the file server first comes up, the system creates one print queue for each printer. The operating system automatically assigns the group EVERYONE as a print queue user of these queues. All network users, as a result, can send print requests to the system-created print queue(s).

The supervisor is automatically assigned as a print queue operator for system-created print queues.

Printers normally service print requests on a first-come, first-served basis. However, users designated as print queue operators have special privileges. They can change a print job's position in the queue, put the job on hold, or delete the job altogether.

The system also creates a default print job configuration. This configuration will print one copy of a file with a banner, a page which specifies the username of the user making the print request and the name of the file. The file will be printed according to the parameters set directly on the printer.

If these system defaults meet your printing needs, you can skip to "Printing on the Network" on page 10-12.

## CUSTOMIZING NETWORK PRINTING

If the system defaults do not meet your network's needs, or if you want to have more flexibility in printing, you can customize your network's printing abilities in the following ways:

- You can create new print queues and change the default print queue and spooler mappings.
- You can assign network users to be print queue users. In addition, you may want to change users' printing privileges by changing the default queue users and operators.
- You can assign print queue operators to manage queue operations.
- You can choose to change your printer's default parameters by setting up various print definitions which determine how print job requests will be printed.

The printing utilities, PRINTDEF, PRINTCON, and PCONSOLE, allow you to customize your printing environment and are described briefly in the subheadings below. For a complete explanation, see the *NetWare Supervisor Reference* or *NetWare Menu Utilities* manual.

### PRINTDEF: DEFINING PRINTING PARAMETERS, MODES, AND FORMS

The PRINTDEF (Printer Definition) utility allows you, as supervisor, to create a database of printing parameters that can be used by other network users. Using PRINTDEF, you define your printer(s) by making a list of functions or printer commands (for example, 10 characters per inch (cpi), near-letter quality, 6 lines per inch, etc.). The printer commands control such things as orientation, spacing, pitch, character set, font and point size.

You can then combine these functions into modes. A mode is simply a sequence of printer commands which tells the printer how to print a particular job. For example, you could create a "Final Print Out" mode that would include the functions or printer commands for 10 cpi, emphasized printing, and near-letter quality printing.

NetWare v2.15 contains print device definitions for 39 printers. These print device definitions are copied automatically into the SYS:PUBLIC directory during installation. You must use the PRINTDEF utility to import these print device definitions into the PRINTDEF database for your server.

PRINTDEF also allows you to specify different forms (types of paper) that are available for your printers. For example, you may want to use continuous-feed paper for some print jobs and 8 1/2 by 11 inch sheets of paper for others. You can also specify a separate form for letterhead paper or quality paper.

Other forms include address labels, checks, and green-bar paper.

There is only one PRINTDEF file per file server.

For a complete explanation of the PRINTDEF utility, see Chapter 6 of the *NetWare Supervisor Reference*.

## PRINTCON: SETTING UP PRINT JOB CONFIGURATIONS

The PRINTCON (Print Configuration) utility allows users to set up job configurations that control the way print requests will be printed. This utility allows users to select a job configuration set up by the supervisor or create an individual job configuration.

Users set up print job configurations by selecting from the modes and forms created by the supervisor in PRINTDEF and by specifying other options such as the number of copies, the type of banner, and the print queue.

For example, a supervisor could set up a print configuration called REPORTS for printing daily sales reports. A specific user might also want to set up a print configuration called PROGRAM for printing programming files. Then, instead of having to remember how many copies, which queue or printer, what type of form, etc., the user simply needs to enter the name of the appropriate job configuration.

A complete explanation of PRINTCON is found in Chapter 7 of the *NetWare Supervisor Reference*.

## PCONSOLE: WORKING WITH PRINT QUEUES

The PCONSOLE (Print Console) utility allows queue users to print by putting a print job in a queue. PCONSOLE also allows queue users to choose from the job configurations created in PRINTCON.

As supervisor, you may choose to allow only certain users to access a given print queue by designating only those individuals as queue users. You can also set up queue operators, and thus control who will be given special privileges to control the queue.

As supervisor, you can create new queues in PCONSOLE. When you create a new queue, the user Supervisor is automatically assigned as a queue operator, and the group EVERYONE is automatically assigned as queue user.

You must also map the new queue to a printer using the ADD QUEUE TO PRINTER console command and assign a spooler to the new print queue using the CHANGE SPOOLER MAPPING console command. You can save these commands in the AUTOEXEC.SYS file, as explained in "Printer Mappings: Console Commands or AUTOEXEC.SYS File" on page 10-10.

A complete explanation of PCONSOLE can be found in Chapter 8 of the *NetWare Supervisor Reference* and Chapter 7 of the *NetWare Menu Utilities* manual.

## SPOOLER MAPPINGS

Spooler mappings provide compatibility with other NetWare versions. They are also necessary for the NPRINT and CAPTURE commands to function properly. If you create new print queues using either PCONSOLE or the CREATE NEW PRINT QUEUE console command, you must also create a new spooler mapping with the CHANGE SPOOLER MAPPING console command.

You can use NetWare v2.15 to print a job sent from a NetWare v2.0a or below network. To send a NetWare v2.0a print job to a printer on a network running NetWare v2.15, use the SPOOL command to send the file to a printer. NetWare v2.15 will take the print request and send it to a print queue on the file server. The spooler mappings assign a spooler to a print queue. The request will then be serviced by the printer attached to that queue.

If you want to send files from a file server running NetWare v2.15 to a printer attached to a server running NetWare v2.0a or below, you must copy the files from the v2.15 server to the v2.0a server before you can print the files.

The default setting is one spooler assigned to each print queue.



## PRINTER MAPPINGS: CONSOLE COMMANDS OR AUTOEXEC.SYS FILE

The print queues that the NetWare operating system creates are automatically mapped to printers. Any print queues you create, either with PCONSOLE or with the CREATE NEW PRINT QUEUE console command, must be mapped to a printer. You can set up the appropriate mappings between print queues and printers by issuing commands at the file server console or by creating an AUTOEXEC.SYS file.

When the file server first comes up, it looks for an AUTOEXEC.SYS file. If no file exists, it will automatically create one print queue for each printer and map the queue to the printer. If an AUTOEXEC.SYS file does exist, the system will read the file to set up print queue mappings.

The AUTOEXEC.SYS file contains a list of console commands. You can make this file by using the COPY CON command or by using "Supervisor Options" in the SYSCON utility. Complete instructions for creating an AUTOEXEC.SYS file are in Chapter 4 of the *NetWare Supervisor Reference*.

The AUTOEXEC.SYS file also saves spooler mappings. If you create an AUTOEXEC.SYS file for print queue mappings, you must also include the spooler mappings.

### IMPORTANT:

If you create an AUTOEXEC.SYS file, you must include at least the default print queue and spooler mappings. You must put in the AUTOEXEC.SYS file any print queue mappings or spooler mappings that you want set up automatically each time the file server comes up. Mappings that are not put in the AUTOEXEC.SYS file will no longer be in effect after the file server is taken down.

For your convenience, we have included some of the important console printing commands with a description of the command function. Complete explanations for the console commands can be found in the *NetWare Console Reference*.

Console commands are entered at the file server console only. (The information in brackets is optional.)

- To map a queue to a printer

```
P[RINTER] nn ADD [QUEUE] name
```

or

```
P[RINTER] nn = [QUEUE] name
```

- To list the printers attached to the file server

```
P[RINTER]
```

- To list queues servicing a printer

```
P[RINTER] nn [Q[UEUE{S}]]
```

- To list queues

```
Q[UEUE{S}]
```

- To create a queue

```
Q[UEUE] name CREATE
```

- To change a form

```
P[RINTER] nn MOUNT [FORM]
```

- To map a spooler to a queue

```
S[POOL] nn = name
```

- To list spooler mappings

```
S[POOL]
```

## PRINTING ON THE NETWORK

Once your network is set up for printing, you are ready to print. The examples we give in this chapter will use the default settings.

To print on the network, you may use the PCONSOLE menu utility; the NPRINT or CAPTURE/ENDCAP command line utilities; or the printing commands of your particular application (if the application is designed for a network).

### PRINTING WITH PCONSOLE

PCONSOLE allows queue users to send files to a print queue. As users send files to the queue, they can choose a variety of printing options by selecting and editing a print job configuration.

The print request from PCONSOLE puts the file into a print queue contained on the file server. The file server's print server process takes the file from the queue and sends it to the printer the queue has been mapped to. (See Figure 10.3.)

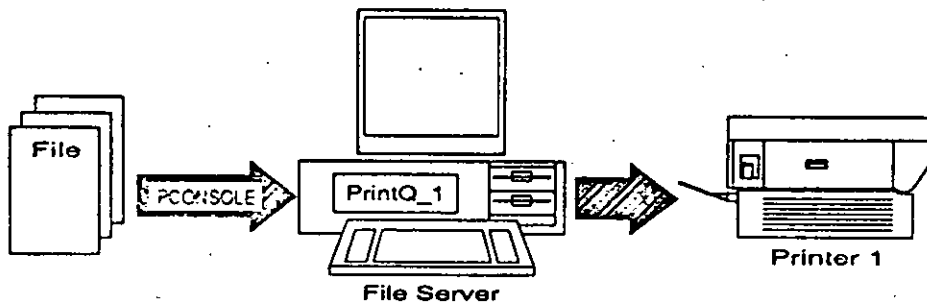

Figure 10.3  
Printing with PCONSOLE

In the following example, you will use PCONSOLE to print the file SALARIES from the SYS:TRAINING\ADMIN\PAYROLL directory. This example assumes that you have created the TRAINING directory and copied the files provided into the directory structure. If you have not, simply substitute your own directory and filenames.

- 1) At the DOS prompt, type

```
PCONSOLE <Enter>
```

to access the Print Console utility.

- 2) Highlight "Print Queue Information" in the "Available Options" menu and press <Enter>. A list of print queues will appear.
- 3) Highlight PRINTQ\_0 and press <Enter>.
- 4) Highlight "Current Print Job Entries" in the "Print Queue Information" box and press <Enter>.
- 5) Press <Insert> to choose a directory to print from. Use the Backspace key to delete all but FILESERVER\SYS: (the name of your file server will replace FILESERVER). Then type

```
TRAINING\ADMIN\ACCT . <Enter>
```

A list of available files will appear.

- 6) Highlight BILLING and press <Enter>.
- 7) Choose the "PConsole Default" print definition by pressing <Enter>.  
PCONSOLE lets you view and edit the print definition before you send it to the print queue. This print definition contains all the default print options.
- 8) Choose this print definition by pressing <Escape> and then <Enter>. The file will be sent to the print queue and then serviced by the printer. Press <ALT> <F10> and then <Enter> to exit the PCONSOLE utility.

## PRINTING WITH THE COMMAND LINE UTILITIES

The command line utilities allow you to issue print requests at the DOS prompt. NPRINT and CAPTURE/ENDCAP can take advantage of any printing parameters set up in PRINTCON. They are fully documented in the *NetWare Command Line Utilities* manual.

### PRINTING WITH NPRINT

The NPRINT command allows you to print files from any directory on the fileserver. You can also print from other file servers if you have the proper rights. The NPRINT command sends the file to a print queue, which is then serviced by the printer mapped to that print queue, as shown in Figure 10.4.

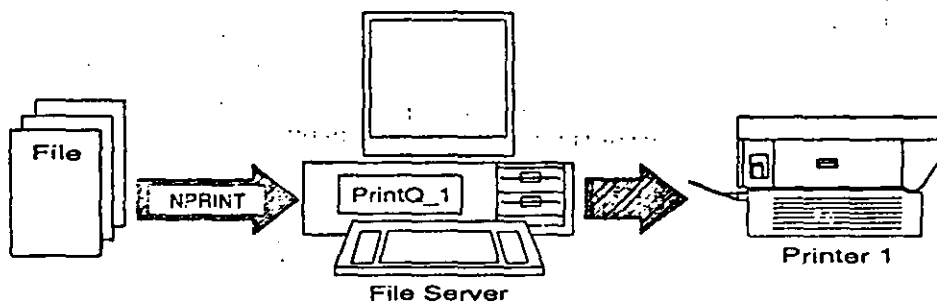

Figure 10.4  
Printing with NPRINT

You can use flags with the NPRINT command to specify the printing parameters, including file server, printer, print queue, number of copies, type of form, and banner information.

In the following example, you will use NPRINT to print two copies of the file STRATEGY from the SYS:TRAINING\MKTG directory. (If you did not create the training directory, simply substitute your own directory and file names.) You will print the file without a banner. Type

```
NPRINT SYS:TRAINING\MKTG\STRATEGY C=2 NB <Enter>
```

### PRINTING WITH CAPTURE/ENDCAP

CAPTURE/ENDCAP allows you to print from applications not specifically designed for networks and screen displays. CAPTURE/ENDCAP also allows you to save or store screen displays in files on the file server's hard disk without actually printing a hard copy.

A standalone computer sends print jobs to locally attached printers. When you issue a print request from the workstation, the request is sent to a printer port which the workstation thinks is connected to a printer.

In network printing, the printers are actually attached to the file server rather than to the workstation. CAPTURE intercepts print requests from the workstation's LPT, or printer port, and sends them to a print queue on the file server. The print queue is then serviced by the appropriate printer.

A workstation has up to three LPT ports, known as LPT1, LPT2, and LPT3. When you issue a CAPTURE command, the system will assume you are sending the print request to LPT1 unless you specify otherwise.

ENDCAP returns the printer port to its original mapping and allows the printing to begin. Figure 10.5 illustrates printing with CAPTURE.

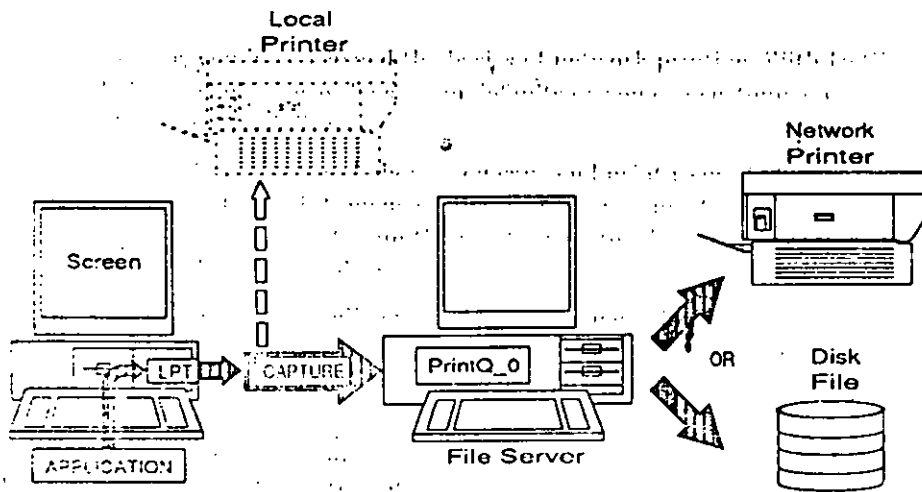

Figure 10.5  
Printing with CAPTURE/ENDCAP

In the following example, you will use CAPTURE/ENDCAP to print a screen from the PCONSOLE utility. This same procedure will work with applications as well.

- 1) At the DOS prompt, type  
CAPTURE <Enter>

Your screen will read something similar to:

Device LPT1: re-routed to queue PrintQ\_0 on server fileserver

- 2) To access the PCONSOLE utility, type  
PCONSOLE <Enter>
- 3) Press <Shift> and <Print Screen> simultaneously. This sends whatever is on the screen to a print queue.

The "autoendcap" feature will automatically print the file after 30 seconds if it does not receive another print request in that time.

- 4) Exit PCONSOLE by pressing <Escape> and then <Enter>.
- 5) Type  
ENDCAP <Enter>

to set the Device LPT1 back to local mode. The ENDCAP command also sends the print request to the queue if you enter it before "autoendcap" has taken effect.

There are a wide variety of options you can choose from when using the CAPTURE/ENDCAP command. Refer to the *NetWare Command Line Utilities* manual for a complete description.

## PRINTING FROM APPLICATIONS

Many popular word processing applications, as well as other types of applications, are specially designed for use on a network. Check the application documentation for instructions about printing.

You can also use the CAPTURE command before going into the application to print directly from the application. At the DOS prompt, type CAPTURE before entering the application. Once you are in the application and have the information you want to print on the screen, press <Shift> and <Print Screen> simultaneously. When you exit the application, type ENDCAP to send the print request to a queue and to reset the printer port to a local mode.

## REVIEW

In this chapter, you have learned the basics of network printing. With NetWare v2.1 and above, you can use the system defaults or you can customize your network for more flexibility.

- Using NetWare v2.1 and above, you can send print requests from a workstation to a print queue on the file server. A print server process takes the print request from the print queue to whichever printer that queue has been mapped to.
- The system automatically creates one print queue for each printer attached to the file server. The group EVERYONE is assigned as a queue user, and SUPERVISOR is assigned as a queue operator for these print queues.
- You can customize your network by using the PRINTDEF, PRINTCON, and PCONSOLE printing utilities. PRINTDEF allows the supervisor to define printing modes and forms. PRINTCON allows any user to set up print job configurations. Using the PCONSOLE utility or the CREATE NEW PRINT QUEUE console command, the supervisor can create new print queues. With PCONSOLE the supervisor can also specify queue users and operators.
- To create new print queue or spooler mappings or to change the system-created mappings, you must use the CREATE NEW PRINT QUEUE or CHANGE SPOOL MAPPING console commands at the file server console or in the AUTOEXEC.SYS file. Only mappings saved in the AUTOEXEC.SYS file will be active when the file server is brought up.
- You can send print requests to a print queue with the PCONSOLE utility or with the NPRINT and CAPTURE/ENDCAP commands.
- Some applications are designed for network printing. If they are not, you can still print from them using the CAPTURE command.

The "Printing Reference Chart" on the facing page summarizes how to set up printing on the network. Each step gives a manual and chapter reference on where to find more information.

## PRINTING REFERENCE CHART

### SETTING UP - SUPERVISOR TASKS

|                              | Automatically Created                                          | Customized                                                                                                                  |
|------------------------------|----------------------------------------------------------------|-----------------------------------------------------------------------------------------------------------------------------|
| 1. Queues                    | One print queue for each physically attached printer           | Use PCONSOLE (Menu Utilities 6) or Console Command QUEUE CREATE (Command Line Utilities 3) to create new queues.            |
| 2. Print Queue Mappings      | One print queue mapped to each physically attached printer     | Use Console Command P ADD QUEUE (Menu Utilities 7) or AUTOEXEC.SYS (Command Line Utilities 3) to map new queues.            |
| 3. Spooler Mappings          | One spooler for each system-created print queue                | Use Console Command S TO QUEUE (Menu Utilities 7) or AUTOEXEC.SYS (Command Line Utilities 3) to map spoolers to new queues. |
| 4. Queue Users and Operators | EVERYONE-Queue user<br>SUPERVISOR-Queue operator               | Use PCONSOLE (Menu Utilities 6) to assign queue users and operators to new queues.                                          |
| 5. Printing Parameters       | Set directly on printer.<br>PCONSOLE default job configuration | Run PRINTDEF (Menu Utilities 7) and PRINTCON (Menu Utilities 7) to set up printer definitions and job configurations.       |

\* User can also set up job configurations

### PRINTING - SUPERVISOR OR USER PRINTING OPTIONS

1. PCONSOLE (Menu Utilities 7)
2. NPRINT (Command Line Utilities 3)
3. CAPTURE/ENDCAP (Command Line Utilities 3)
4. Applications

#### MANUAL REFERENCE LIST:

NetWare Supervisor Reference  
 NetWare Console Reference  
 NetWare Command Line Utilities  
 NetWare Menu Utilities

Curso: MANEJO E INSTALACION DE REDES (LAN) CON  
NETWARE DE NOVELL

Practica

MICROCOMPUTADORA:

MARCA: \_\_\_\_\_ MODELO: \_\_\_\_\_ TECNOLOGIA: \_\_\_\_\_  
PROCESADOR: \_\_\_\_\_ VELOCIDAD: \_\_\_\_\_ MH COPROC: \_\_\_\_\_  
SERIE N°: \_\_\_\_\_ DISCO DURO DE \_\_\_\_\_ MB SERIE N° \_\_\_\_\_  
TECLADO SERIE N° \_\_\_\_\_ MONITOR SERIE N° \_\_\_\_\_  
\_\_\_\_\_ TECLAS \_\_\_\_\_ VIDEO TIPO \_\_\_\_\_

CONFIGURACION:

RAM: \_\_\_\_\_ VELOCIDAD: \_\_\_\_\_  
DRIVE 1: \_\_\_\_\_ FORMATO: \_\_\_\_\_ CAPACIDAD: \_\_\_\_\_  
DRIVE 2: \_\_\_\_\_ FORMATO: \_\_\_\_\_ CAPACIDAD: \_\_\_\_\_  
D. DURO: TEC \_\_\_\_\_ FORMATO: \_\_\_\_\_ CAPACIDAD: \_\_\_\_\_  
BIOS : FABRICANTE \_\_\_\_\_ VERSION: \_\_\_\_\_

TARJETAS Y/O PUERTOS:

|           |                |           |                    |           |
|-----------|----------------|-----------|--------------------|-----------|
| 1.- _____ | DIR. E/S _____ | IRQ _____ | MEN. ADDRESS _____ | DMA _____ |
| 2.- _____ | DIR. E/S _____ | IRQ _____ | MEN. ADDRESS _____ | DMA _____ |
| 3.- _____ | DIR. E/S _____ | IRQ _____ | MEN. ADDRESS _____ | DMA _____ |
| 4.- _____ | DIR. E/S _____ | IRQ _____ | MEN. ADDRESS _____ | DMA _____ |
| 5.- _____ | DIR. E/S _____ | IRQ _____ | MEN. ADDRESS _____ | DMA _____ |
| 6.- _____ | DIR. E/S _____ | IRQ _____ | MEN. ADDRESS _____ | DMA _____ |

PRUEBAS INICIALES:

MEMORIA: \_\_\_\_\_ VIDEO: \_\_\_\_\_  
DRIVE 1: \_\_\_\_\_ (L/E) \_\_\_\_\_ TECLADO: \_\_\_\_\_  
DRIVE 2: \_\_\_\_\_ (L/E) \_\_\_\_\_ D. DURO: \_\_\_\_\_ (L/E) \_\_\_\_\_

OBSERVACIONES: \_\_\_\_\_  
\_\_\_\_\_  
\_\_\_\_\_

EQUIPO N° \_\_\_\_\_ NOMBRES: \_\_\_\_\_  
\_\_\_\_\_

FECHA: \_\_\_\_/\_\_\_\_/\_\_\_\_

EVALUACION: \_\_\_\_\_