



**FACULTAD DE INGENIERIA U.N.A.M.
DIVISION DE EDUCACION CONTINUA**

**CENTRO DE INFORMACIÓN Y DOCUMENTACIÓN
" ING. BRUNO MASCANZONI "**

El Centro de Información y Documentación Ing. Bruno Mascanzoni tiene por objetivo satisfacer las necesidades de actualización y proporcionar una adecuada información que permita a los ingenieros, profesores y alumnos estar al tanto del estado actual del conocimiento sobre temas específicos, enfatizando las investigaciones de vanguardia de los campos de la ingeniería, tanto nacionales como extranjeras.

Es por ello que se pone a disposición de los asistentes a los cursos de la DECFI, así como del público en general los siguientes servicios:

- **Préstamo interno.**
- **Préstamo externo.**
- **Préstamo interbibliotecario.**
- **Servicio de fotocopiado.**
- **Consulta a los bancos de datos: librunam, seriunam en cd-rom.**

Los materiales a disposición son:

- **Libros.**
- **Tesis de posgrado.**
- **Publicaciones periódicas.**
- **Publicaciones de la Academia Mexicana de Ingeniería.**
- **Notas de los cursos que se han impartido de 1988 a la fecha.**

En las áreas de ingeniería industrial, civil, electrónica, ciencias de la tierra, computación y, mecánica y eléctrica.

El CID se encuentra ubicado en el mezzanine del Palacio de Minería, lado oriente.

El horario de servicio es de 10:00 a 14:30 y 16:00 a 17:30 de lunes a viernes.



**FACULTAD DE INGENIERIA U.N.A.M.
DIVISION DE EDUCACION CONTINUA**

A LOS ASISTENTES A LOS CURSOS

Las autoridades de la Facultad de Ingeniería, por conducto del jefe de la División de Educación Continua, otorgan una constancia de asistencia a quienes cumplan con los requisitos establecidos para cada curso.

El control de asistencia se llevará a cabo a través de la persona que le entregó las notas. Las inasistencias serán computadas por las autoridades de la División, con el fin de entregarle constancia solamente a los alumnos que tengan un mínimo de 80% de asistencias.

Pedimos a los asistentes recoger su constancia el día de la clausura. Estas se retendrán por el periodo de un año, pasado este tiempo la DECFI no se hará responsable de este documento.

Se recomienda a los asistentes participar activamente con sus ideas y experiencias, pues los cursos que ofrece la División están planeados para que los profesores expongan una tesis, pero sobre todo, para que coordinen las opiniones de todos los interesados, constituyendo verdaderos seminarios.

Es muy importante que todos los asistentes llenen y entreguen su hoja de inscripción al inicio del curso, información que servirá para integrar un directorio de asistentes, que se entregará oportunamente.

Con el objeto de mejorar los servicios que la División de Educación Continua ofrece, al final del curso deberán entregar la evaluación a través de un cuestionario diseñado para emitir juicios anónimos.

Se recomienda llenar dicha evaluación conforme los profesores impartan sus clases, a efecto de no llenar en la última sesión las evaluaciones y con esto sean más fehacientes sus apreciaciones.

**Atentamente
División de Educación Continua.**

PALACIO DE MINERIA

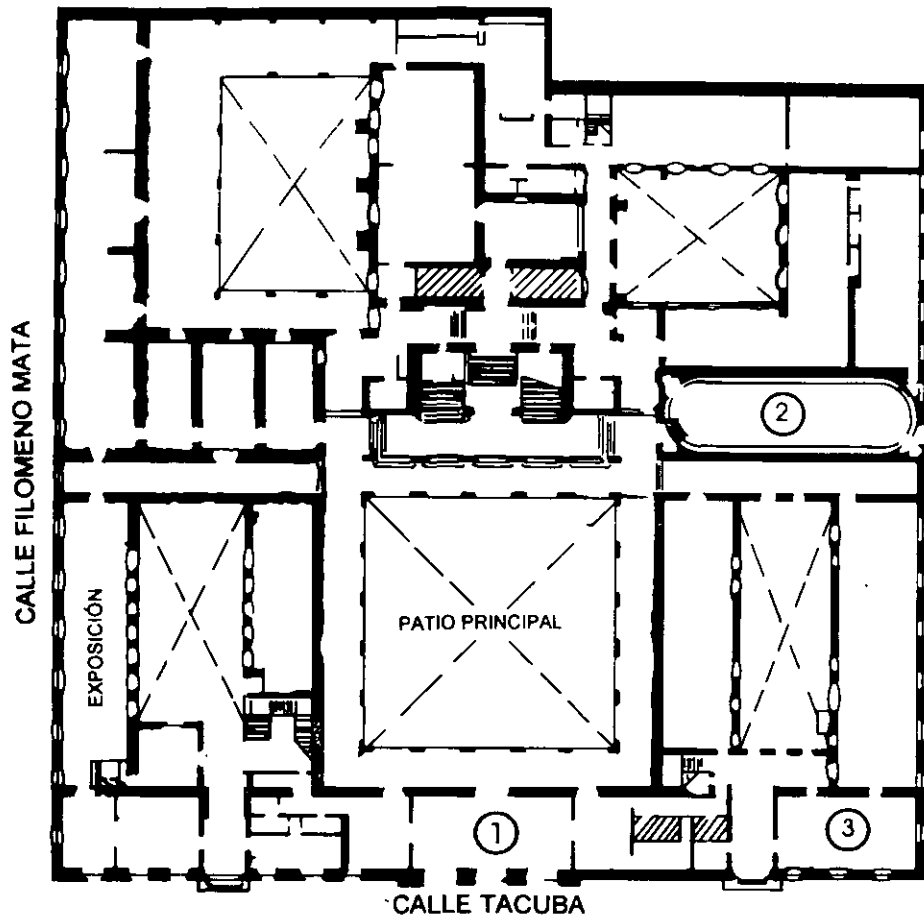

PLANTA BAJA

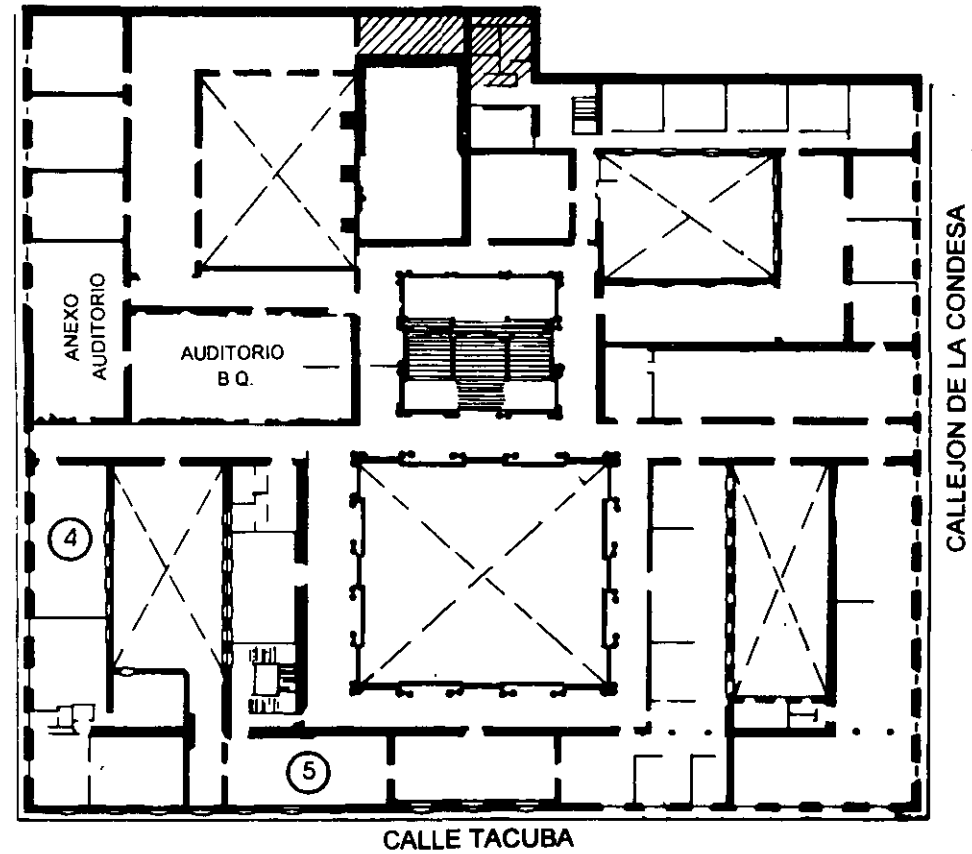

MEZZANINNE

PALACIO DE MINERIA

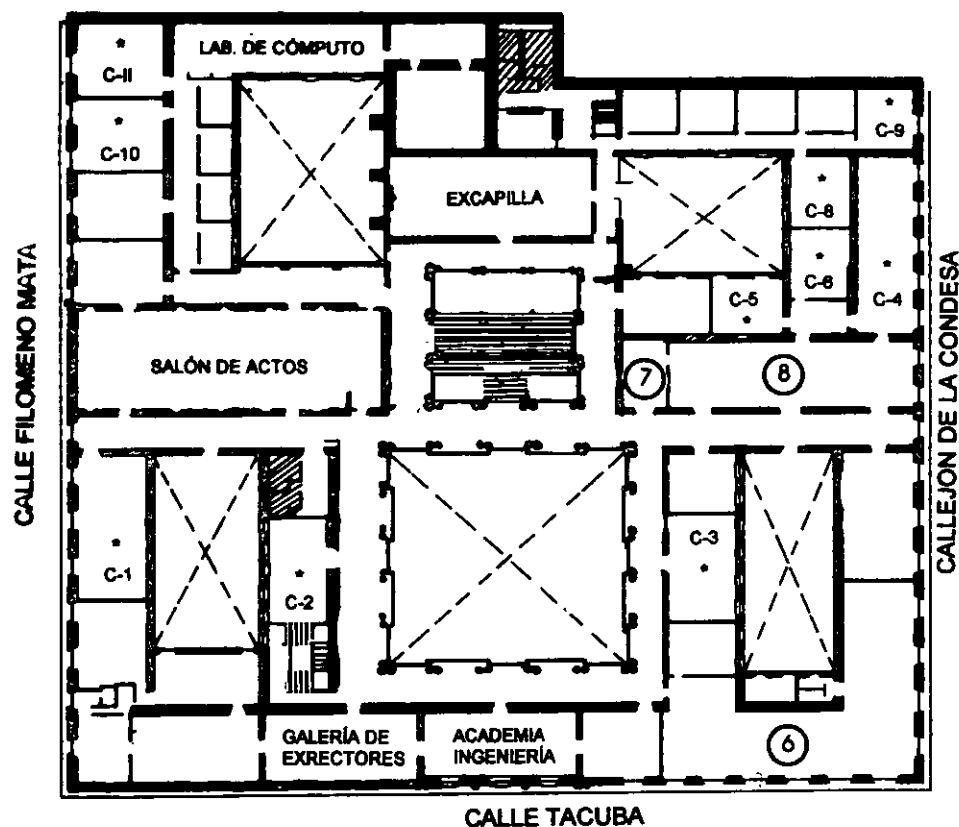

GUÍA DE LOCALIZACIÓN

1. ACCESO
2. BIBLIOTECA HISTÓRICA
3. LIBRERÍA UNAM
4. CENTRO DE INFORMACIÓN Y DOCUMENTACIÓN "ING. BRUNO MASCANZONI"
5. PROGRAMA DE APOYO A LA TITULACIÓN
6. OFICINAS GENERALES
7. ENTREGA DE MATERIAL Y CONTROL DE ASISTENCIA
8. SALA DE DESCANSO

SANITARIOS

* AULAS

1er. PISO



DIVISIÓN DE EDUCACIÓN CONTINUA
FACULTAD DE INGENIERÍA U.N.A.M.
CURSOS ABIERTOS

DIVISIÓN DE EDUCACIÓN CONTINUA





DIVISION DE EDUCACION CONTINUA
FACULTAD DE INGENIERIA, UNAM
CURSOS ABIERTOS



CURSO: CC072) CABLEADO ESTRUCTURADO

FECHA: 6 AL 10 DE NOVIEMBRE, 2000

EVALUACIÓN DEL PERSONAL DOCENTE

(ESCALA DE EVALUACIÓN. 1 A 10)

CONFERENCISTA	DOMINIO DEL TEMA	USO DE AYUDAS AUDIOVISUALES	COMUNICACION CON EL ASISTENTE	PUNTUALIDAD
ADRIAN MAGAÑA CISNEROS				

Promedio _____

EVALUACIÓN DE LA ENSEÑANZA

CONCEPTO	CALIF
ORGANIZACIÓN Y DESARROLLO DEL CURSO	
GRADO DE PROFUNDIDAD DEL CURSO	
ACTUALIZACIÓN DEL CURSO	
APLICACION PRACTICA DEL CURSO	

Promedio _____

EVALUACIÓN DEL CURSO

CONCEPTO	CALIF
CUMPLIMIENTO DE LOS OBJETIVOS DEL CURSO	
CONTINUIDAD EN LOS TEMAS	
CALIDAD DEL MATERIAL DIDÁCTICO UTILIZADO	

Promedio _____

Evaluación total del curso _____

Continúa...2

1. ¿Le agradó su estancia en la División de Educación Continua?

SI

NO

Si indica que "NO" diga porqué:

2. Medio a través del cual se enteró del curso:

Periódico <i>La Jornada</i>	
Folleto anual	
Folleto del curso	
Gaceta UNAM	
Revistas técnicas	
Otro medio (Indique cuál)	

3. ¿Qué cambios sugeriría al curso para mejorarlo?

4. ¿Recomendaría el curso a otra(s) persona(s) ?

SI

NO

5. ¿Qué cursos sugiere que imparta la División de Educación Continua?

6. Otras sugerencias:



**FACULTAD DE INGENIERIA U.N.A.M.
DIVISION DE EDUCACION CONTINUA**

MATERIAL DIDACTICO DEL CURSO

CABLEADO ESTRUCTURADO

NOVIEMBRE, 2000

DIVISIÓN DE EDUCACIÓN CONTINUA DE
LA FACULTAD DE INGENIERIA.

DIPLOMADO EN REDES DE
COMPUTADORAS Y TELECOMUNICACIONES.

Cableado Estructurado
(Ingeniería y Certificación)

Coord. Académico: Ing. Saúl S. Magaña Cisneros

Cableado Estructurado (Ingeniería y Certificación)

Temas

1

INTRODUCCIÓN

2

TECNOLOGÍAS DE REDES Y MEDIOS DE COMUNICACIÓN

3

ESPECIFICACIONES Y DISEÑO

4

DIAGNÓSTICO Y CERTIFICACIÓN

5

ANÁLISIS DEL MERCADO

PRESENTACIÓN:

En la actualidad empresas y organismos utilizan sus equipos de computo interconectados en redes y a su vez estas redes conectadas a otras redes y a Internet. En el surgimiento de las redes locales de computadoras la tecnología utilizada en los medios de comunicación no era tan rigida ni podía ofrecer el potencial de las del día de hoy. En un sistema de **Cableado Estructurado** moderno existen muchas consideraciones técnicas, de diseño, de rendimiento, económicas, de mercado, de normas, etc. Por lo que es trascendental que dentro de un diplomado de esta naturaleza se dedique un modulo al estudio completo de los medios físico de comunicación en una red de computadoras lo que se ha denotado **Cableado Estructurado**.

En primera instancia **Cableado Estructurado** debe concebirse como el establecimiento de los medio de comunicación integrales que cubran las necesidades de empresas y organismos. Cableado integral que debe contemplar datos, voz e imagen con los anchos de banda y velocidades adecuadas además de tener un crecimiento modular.

Desgraciadamente en mercados como el nuestro todavía hay empresas que hacen inversiones en un cableado para voz y otro para datos y ni siquiera contemplan la posibilidad de transmisión de video. De aquí la importancia del conocimiento de la tecnología de **Cableado Estructurado**

En este curso se analizaran las normas internacionales que regulan el **Cableado Estructurado**, se definirán las reglas de ingeniería para el diseño de sistemas de **Cableado Estructurado**, se estudiarán las diferentes opciones que el mercado mexicano ofrece y se definirán los mecanismos de diagnóstico y certificaciones del **Cableado Estructurado**

OBJETIVO:

Lograr que el participante sea capaz de diseñar, implementar y supervisar un sistema de **Cableado Estructurado** cubriendo la transmisión de voz, datos y video. Así como el establecimiento de los criterios de certificación de un sistema de **Cableado Estructurado**.

A QUIEN VA DIRIGIDO

A ejecutivos, profesionistas, técnicos y personas que por sus necesidades profesionales, requieran diseñar, implementar, supervisar, diagnosticar o certificar un sistema de **Cableado Estructurado**

Al personal técnico administrativo de toma de decisiones en proyectos de infraestructura de comunicaciones de empresas u organismos

REQUISITOS

Los participantes que estén sustentando el diplomado haber cursado los módulos I y II

Para los participantes que tomen este modulo como un curso abierto, es necesario tener un buen nivel de conocimientos en redes de computadoras sobre todo en las tecnologías de comunicaciones.

Temas

1

INTRODUCCIÓN

2

TECNOLOGÍAS DE REDES Y MEDIOS DE COMUNICACIÓN

3

ESPECIFICACIONES Y DISEÑO

4

DIAGNOSTICO Y CERTIFICACION

5

ANALISIS DEL MERCADO

TEMARIO

1. INTRODUCCIÓN

- ☐ Que es el cableado estructurado
- ☐ Ventajas y justificaciones de un sistema de cableado estructurado
- ☐ Conceptos de cableado estructurado
- ☐ Funcionalidad y tecnologías
- ☐ Necesidades actuales y futuras
- ☐ Normas internacionales
- ☐ Normas americanas
- ☐ Normas europeas

2. TECNOLOGÍAS DE REDES Y MEDIOS DE COMUNICACIÓN

- ☐ Tecnologías de Redes
- ☐ Ethernet, Fast Ethernet, Giga Ethernet
- ☐ Token Ring, FDDI
- ☐ ATM
- ☐ Tecnologías de Cableado
- ☐ UTP categoría V y VI
- ☐ STP
- ☐ FTP
- ☐ Fibra Optica
- ☐ Medios multipares

3. ESPECIFICACIONES Y DISEÑO

- ☐ Parámetros de Rendimiento
 - Atenuación
 - Paradiafonia
 - Gráficas ACR
- ☐ Subsistemas
 - Vertical, Horizontal, Campus, etc
 - Closet de Telecomunicaciones "Site"
- ☐ Puntos de acceso
- ☐ Dificultades del ambiente
- ☐ Distribución de rutas
- ☐ Definición de rutas del cable
- ☐ Distribución de energía
- ☐ Panel de parcheo
- ☐ Terminadores
- ☐ Cordones ópticos
- ☐ Consideraciones para la transmisión de Datos
- ☐ Consideraciones para la transmisión de Voz
- ☐ Consideraciones para la transmisión de Video

4 DIAGNOSTICO Y CERTIFICACION

- ☐ Verificación de conexión de la red
- ☐ Verificación del sistema de cableado
- ☐ Topología e identificación
- ☐ Medición de paradiafonia y atenuación
- ☐ Hojas de control
- ☐ Certificación

5 ANALISIS DEL MERCADO

- ☐ Principales Fabricantes
- ☐ Caso de Estudio
- ☐ Análisis de Costos



DIPLOMADO EN REDES DE
COMPUTADORAS (LAN, WANY GAN)

CABLEADO ESTRUCTURADO
(INGENIERIA Y CERTIFICACION)

Introducción



**DIPLOMADO EN REDES DE
COMPUTADORAS
(LAN, WAN y GAN)**

MODULO V

**CABLEADO ESTRUCTURADO
(INGENIERIA Y CERTIFICACION)**

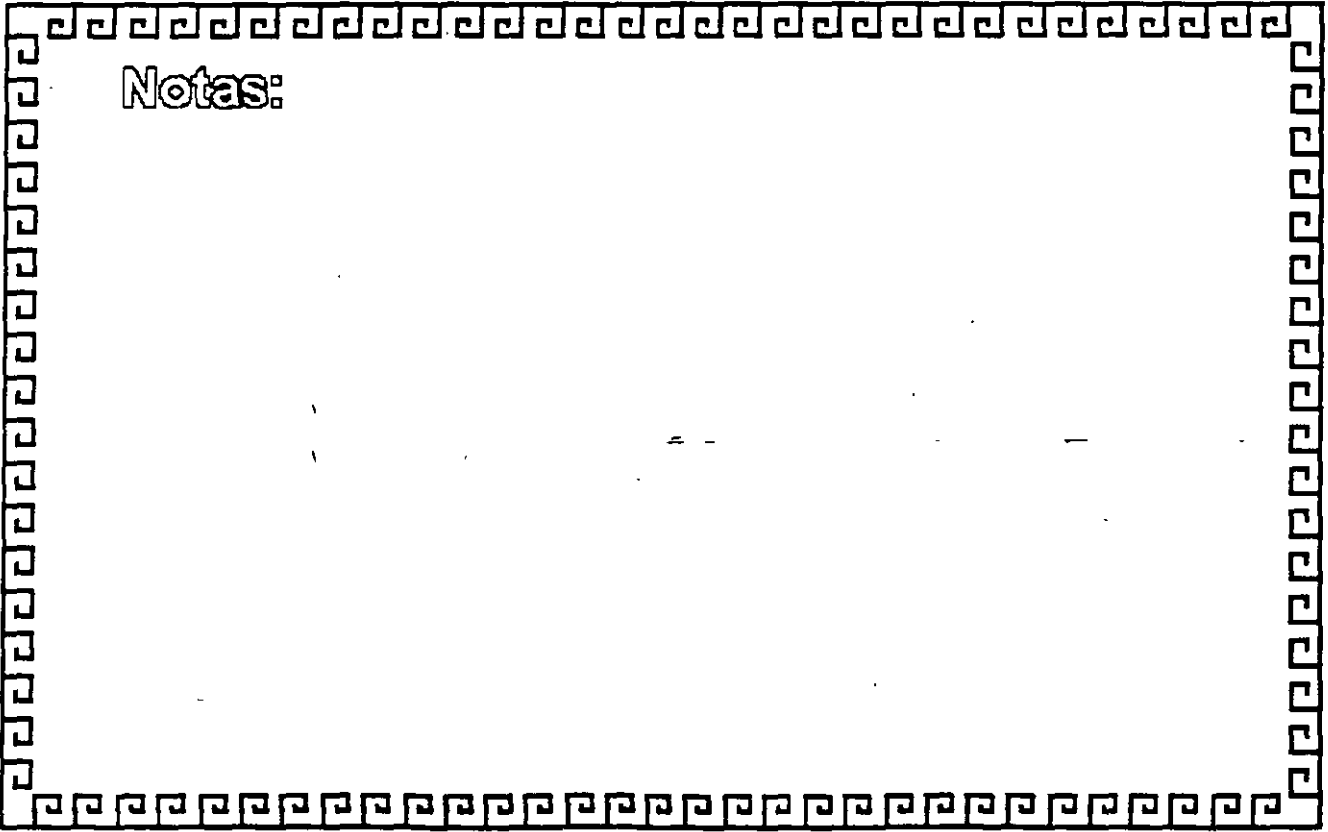

Notas:



CABLEADO ESTRUCTURADO

EXPOSITORES

- ING. SAUL S. MAGAÑA CISNEROS
- ING. JUAN C. MAGAÑA CISNEROS
- ING. GABRIEL PRADO
- ING. ADRIAN MAGAÑA CISNEROS
- ING. VICTOR MANUEL RIVERA CONTRERAS

Ing. Certificados en Sistemas de Cableado

Notas:



PRESENTACION

En un sistema de **Cableado Estructurado** moderno existen muchas consideraciones técnicas, de diseño, de rendimiento, económicas, de mercado, de normas, etc.



Notas:

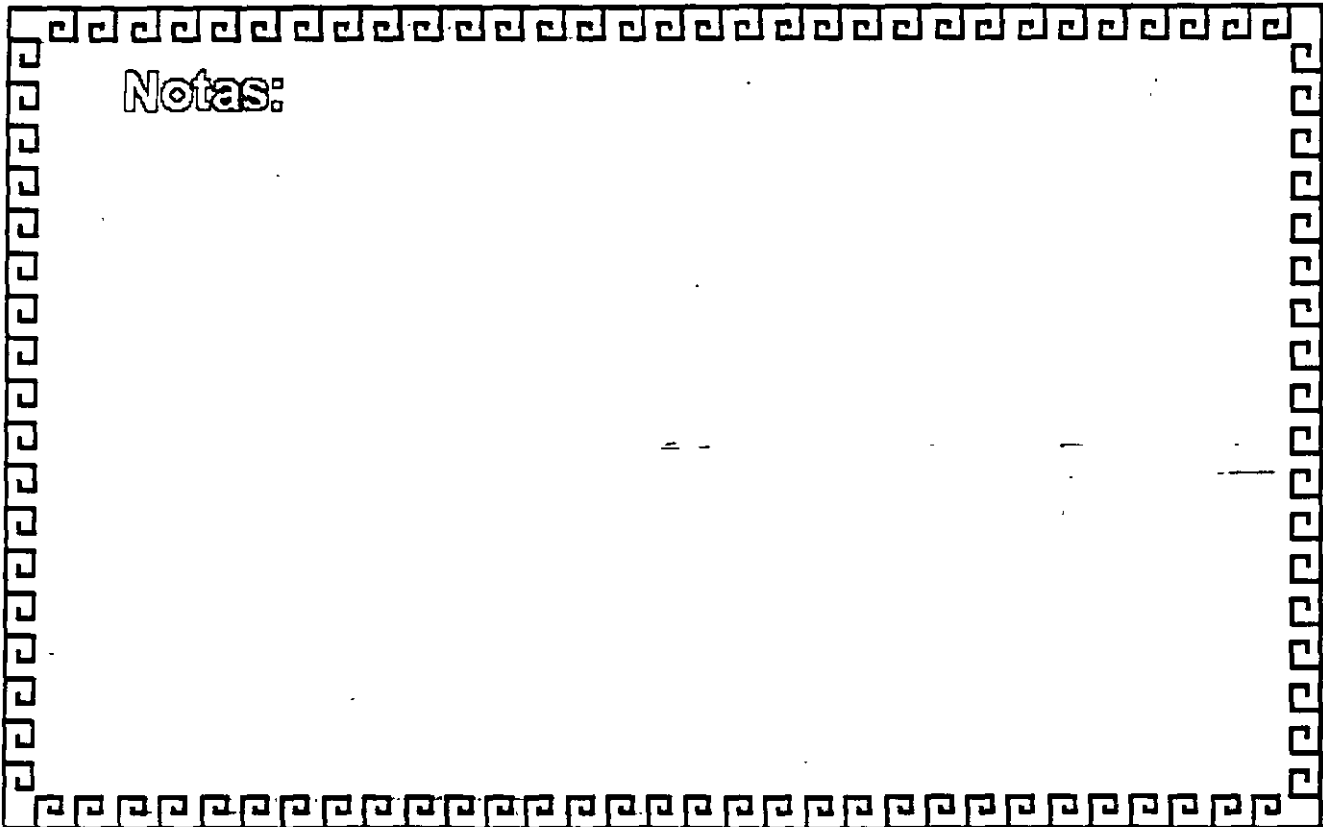



PRESENTACION

En este curso se analizaran las normas internacionales que regulan el **Cableado Estructurado**, se definirán las reglas de ingeniería para el diseño de sistemas de **Cableado Estructurado**, se estudiarán las diferentes opciones que el mercado mexicano ofrece y se definirán los mecanismos de diagnostico y certificaciones.



Notas:

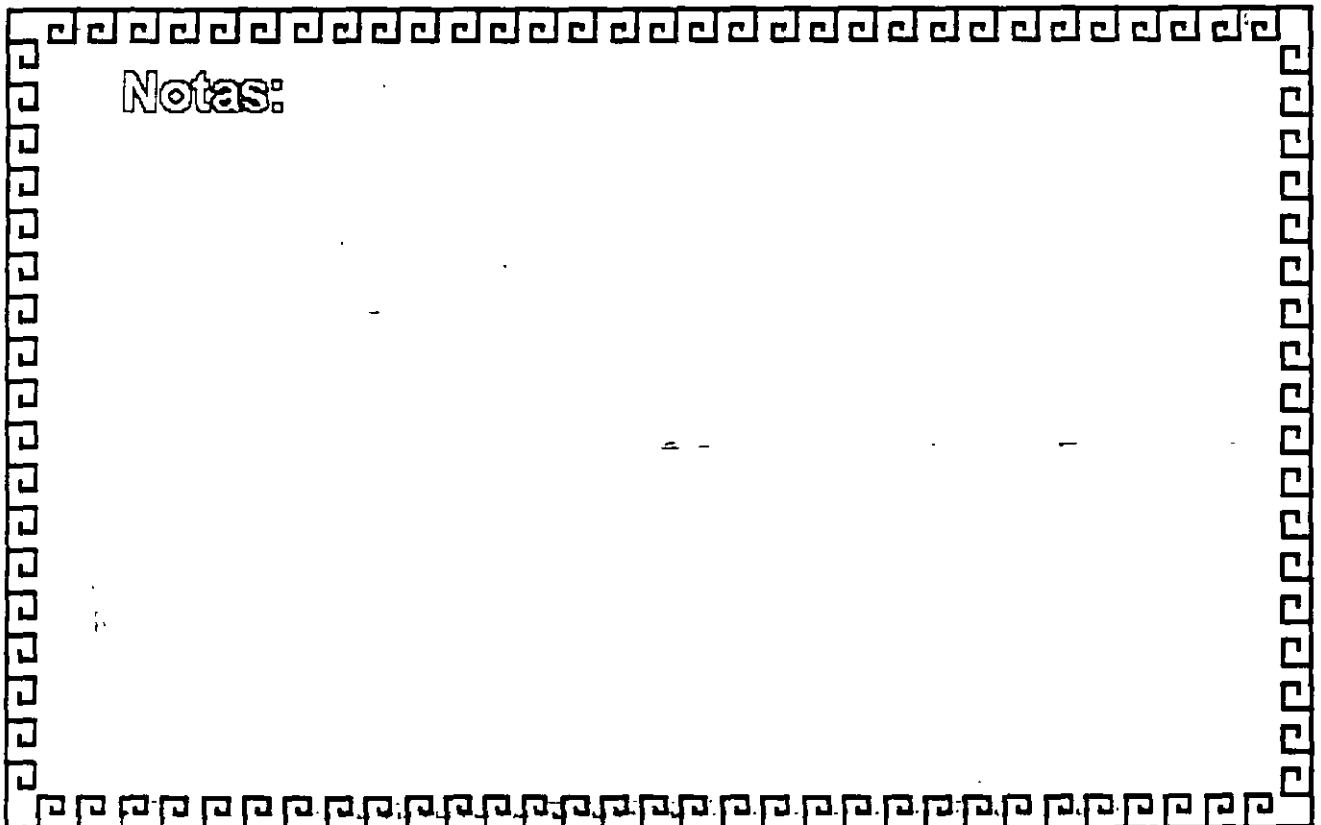



ORIENTACION

A ejecutivos, profesionistas, técnicos y personas que por sus necesidades profesionales, requieran diseñar, implementar, supervisar, diagnosticar o certificar un sistema de **Cableado Estructurado**

Notas:

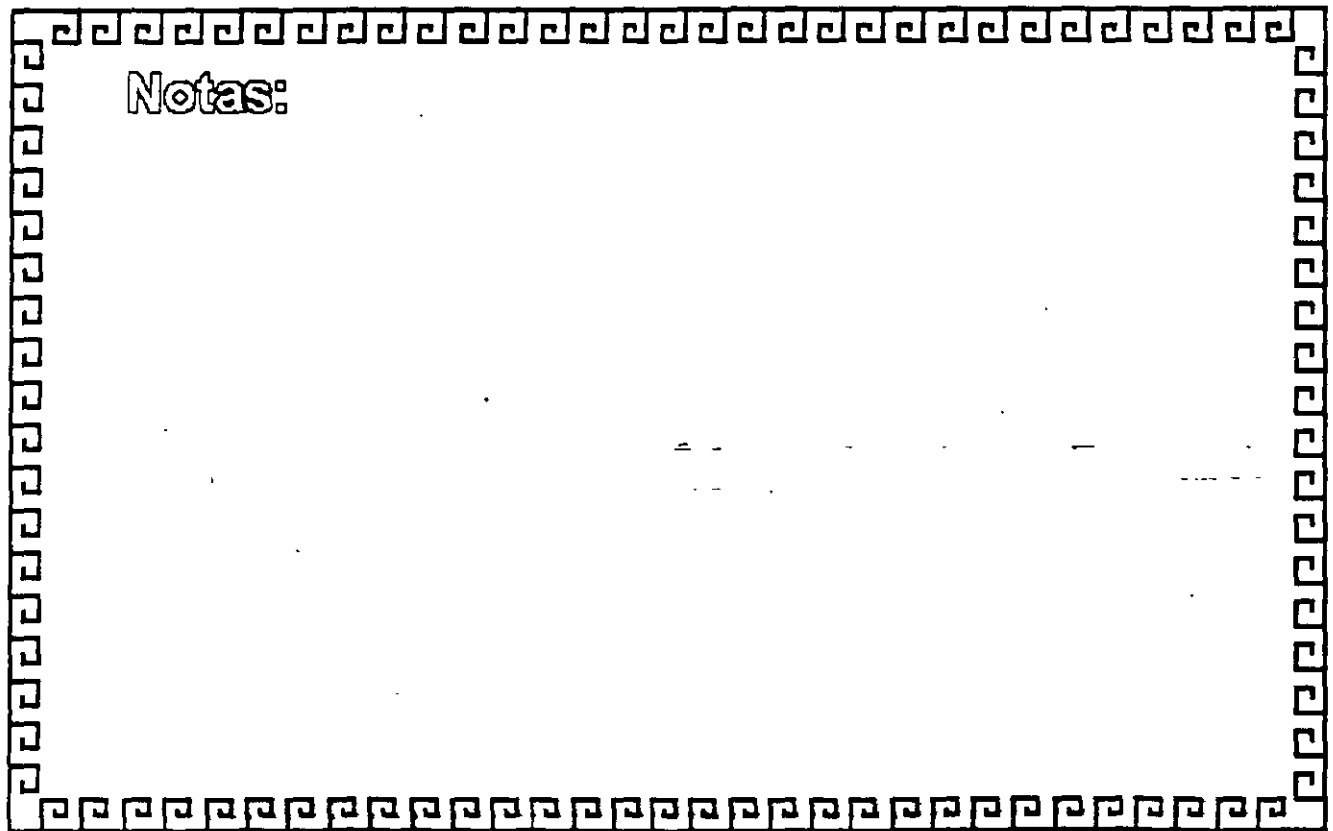



CABLEADO ESTRUCTURADO

TEMARIO

• 1. Introducción

- ~ Que es el cableado estructurado
 - ~ Ventajas y justificaciones de un sistema de cableado estructurado
 - ~ Conceptos de cableado estructurado
 - ~ Funcionalidad y tecnologías
 - ~ Necesidades actuales y futuras
 - ~ Normas internacionales
 - ~ Normas americanas
 - ~ Normas europeas
- 



Notas:



CABLEADO ESTRUCTURADO

TEMARIO

- **2. Tecnologías de Redes y Medios de Comunicación**

- Tecnologías de Redes
- Ethernet, Fast Ethernet, Giga Ethernet
- Token Ring , FDDI
- ATM
- Tecnologías de Cableado
- UTP categoría V y VI



Notas:

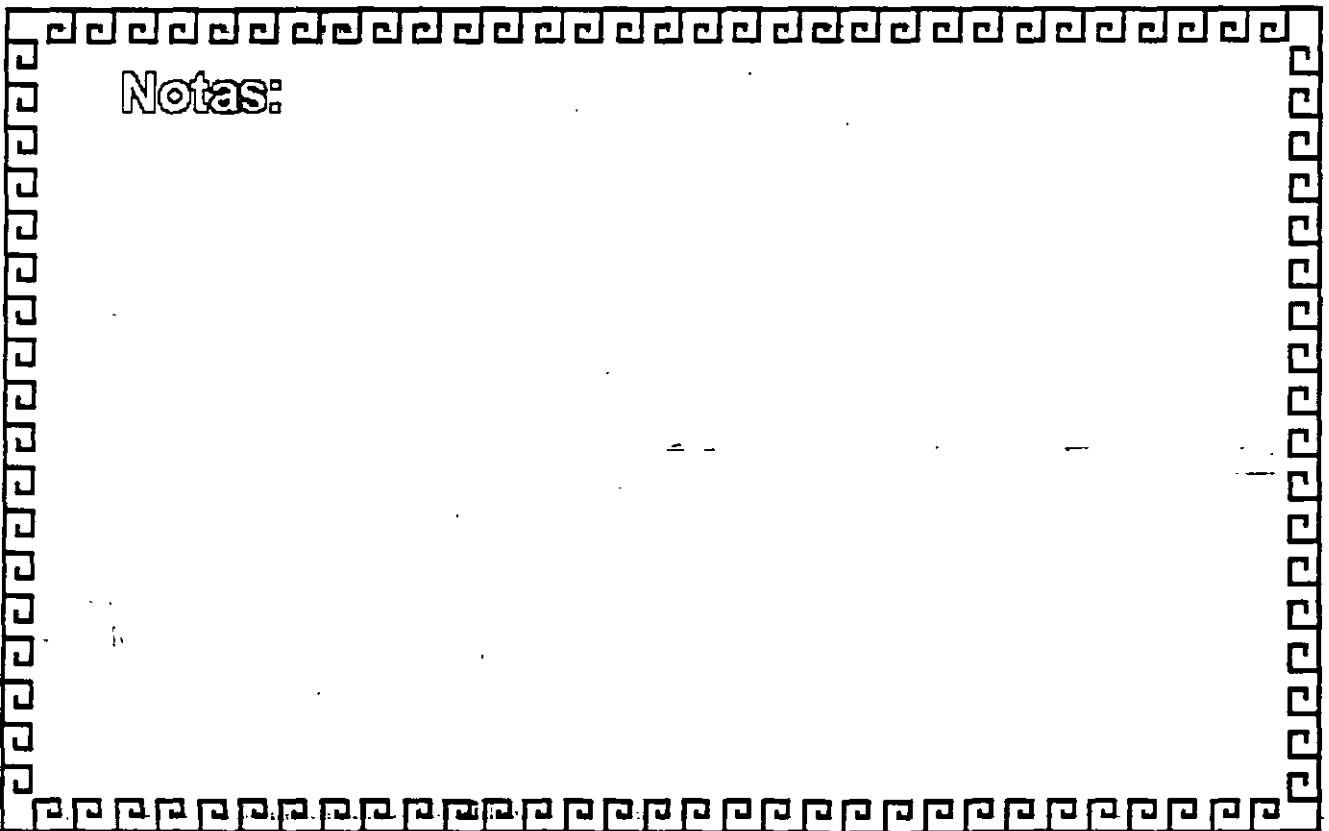



CABLEADO ESTRUCTURADO

TEMARIO

- 2. Tecnologías de Redes y Medios de Comunicación
 - STP
 - FTP
 - Fibra Optica
 - Medios multipares



Notas:

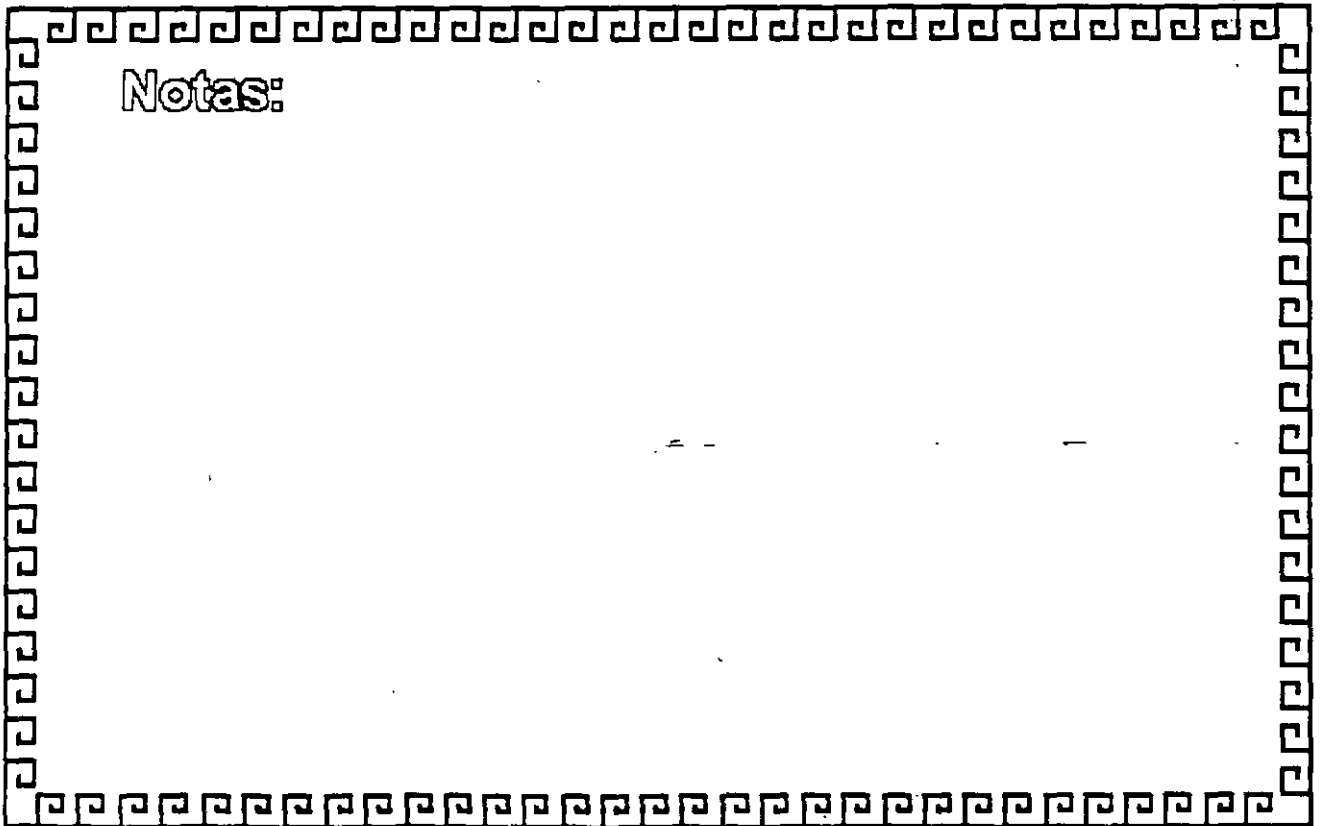



CABLEADO ESTRUCTURADO

TEMARIO

3. Especificaciones y Diseño

☞ Parámetros de Rendimiento

- Atenuación
- Paradiafonia
- Gráficas ACR

☞ Subsistemas

- Vertical, Horizontal, Campus, etc
- Closet de Telecomunicaciones "Site"



Notas:

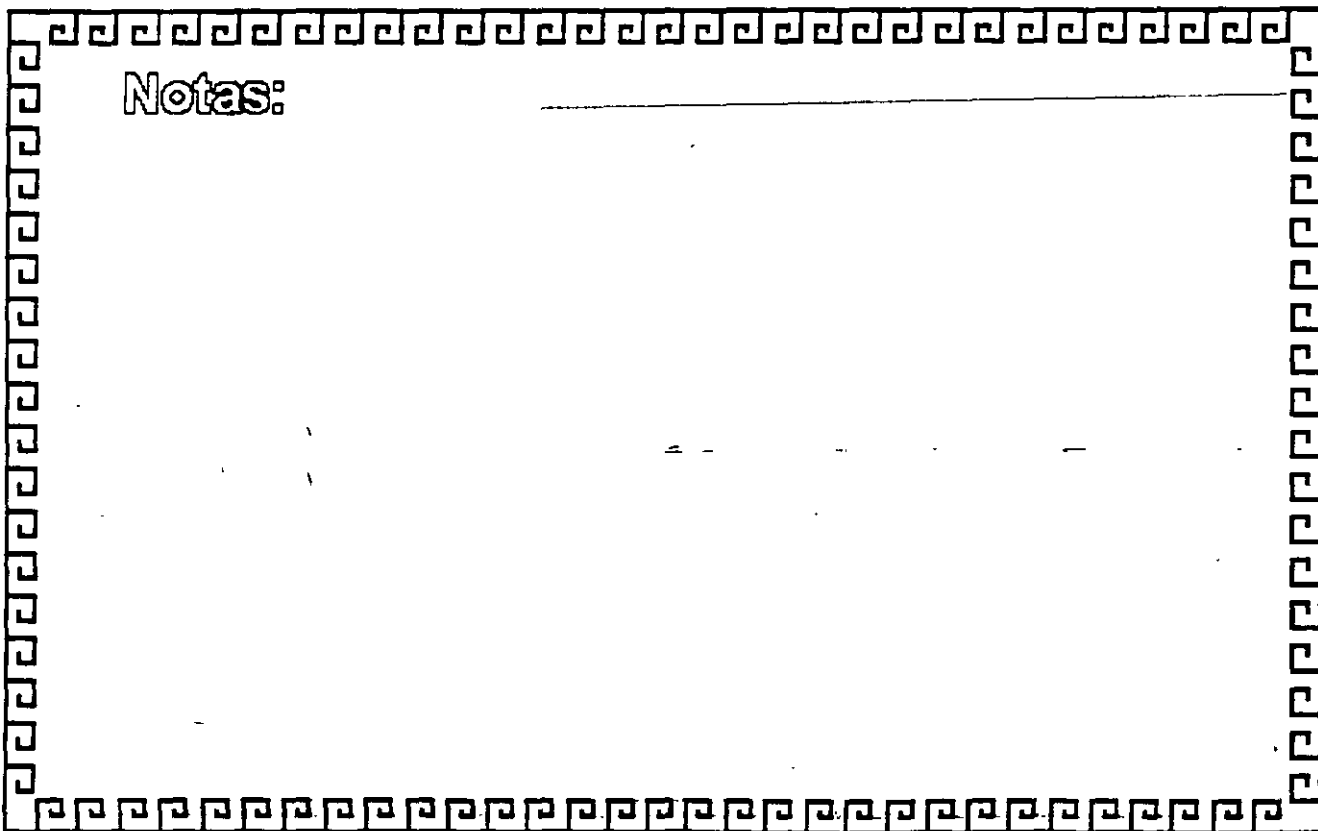



CABLEADO ESTRUCTURADO

TEMARIO

3. Especificaciones y Diseño

- ✓ Puntos de acceso
- ✓ Dificultades del ambiente
- ✓ Distribución de rutas
- ✓ Definición de rutas del cable
- ✓ Distribución de energía
- ✓ Panel de parcheo
- ✓ Terminadores

Notas:



CABLEADO ESTRUCTURADO

- TEMARIO
- 3. Especificaciones y Diseño
 - Cables ópticos
 - Consideraciones para la transmisión de Datos
 - Consideraciones para la transmisión de Voz
 - Consideraciones para la transmisión de Vídeo

Notas:



CABLEADO ESTRUCTURADO

TEMARIO

4 DIAGNOSTICO Y CERTIFICAION

- ~ Verificación de conexión de la red
- ~ Verificación del sistema de cableado
- ~ Topología e identificación
- ~ Medición de paradiafonia y atenuación
- ~ Hojas de control
- ~ Certificación



Notas:

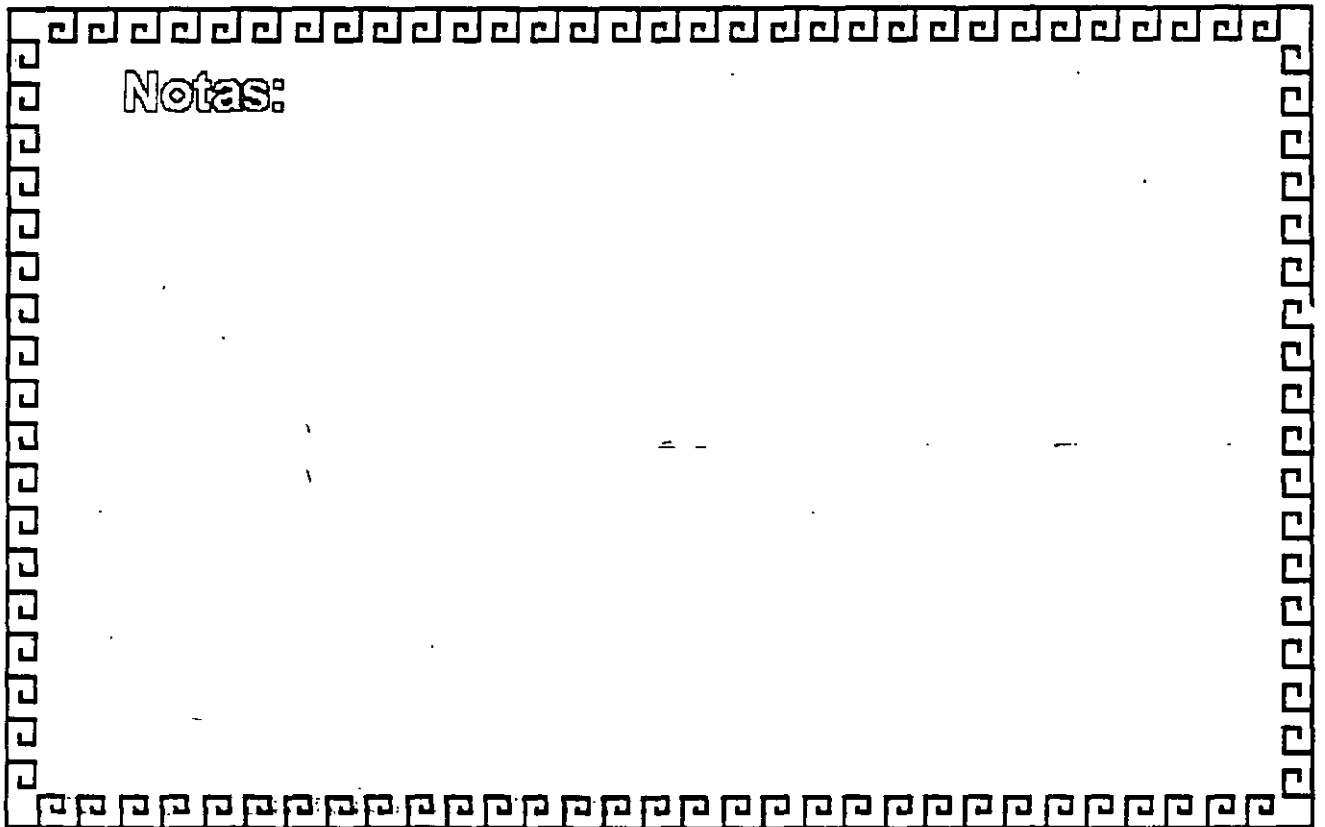



CABLEADO ESTRUCTURADO

TEMARIO

5 Analisis del Mercado

- ✓ Principales Fabricantes
- ✓ Caso de Estudio
- ✓ Análisis de Costos



Notas:

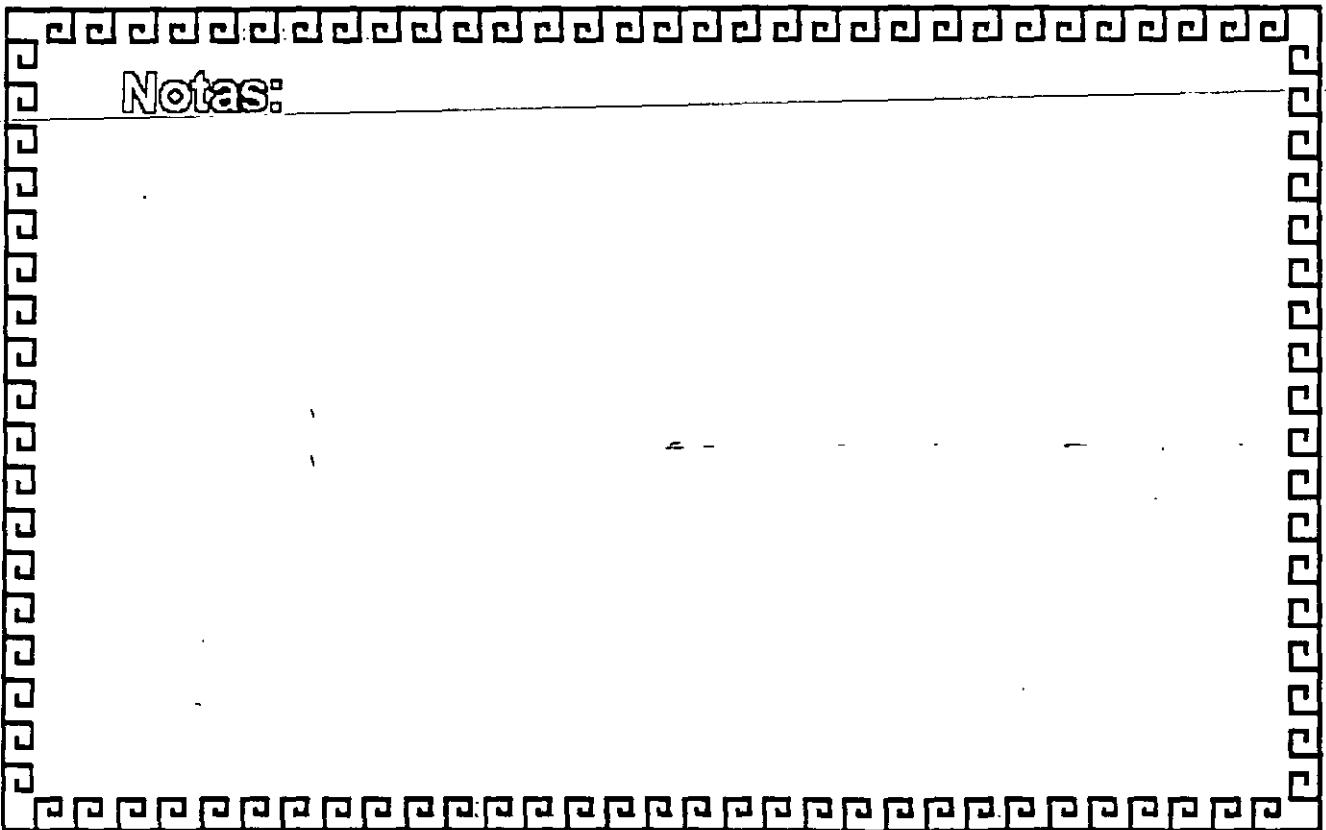



CABLEADO ESTRUCTURADO

INTRODUCCION



Notas:

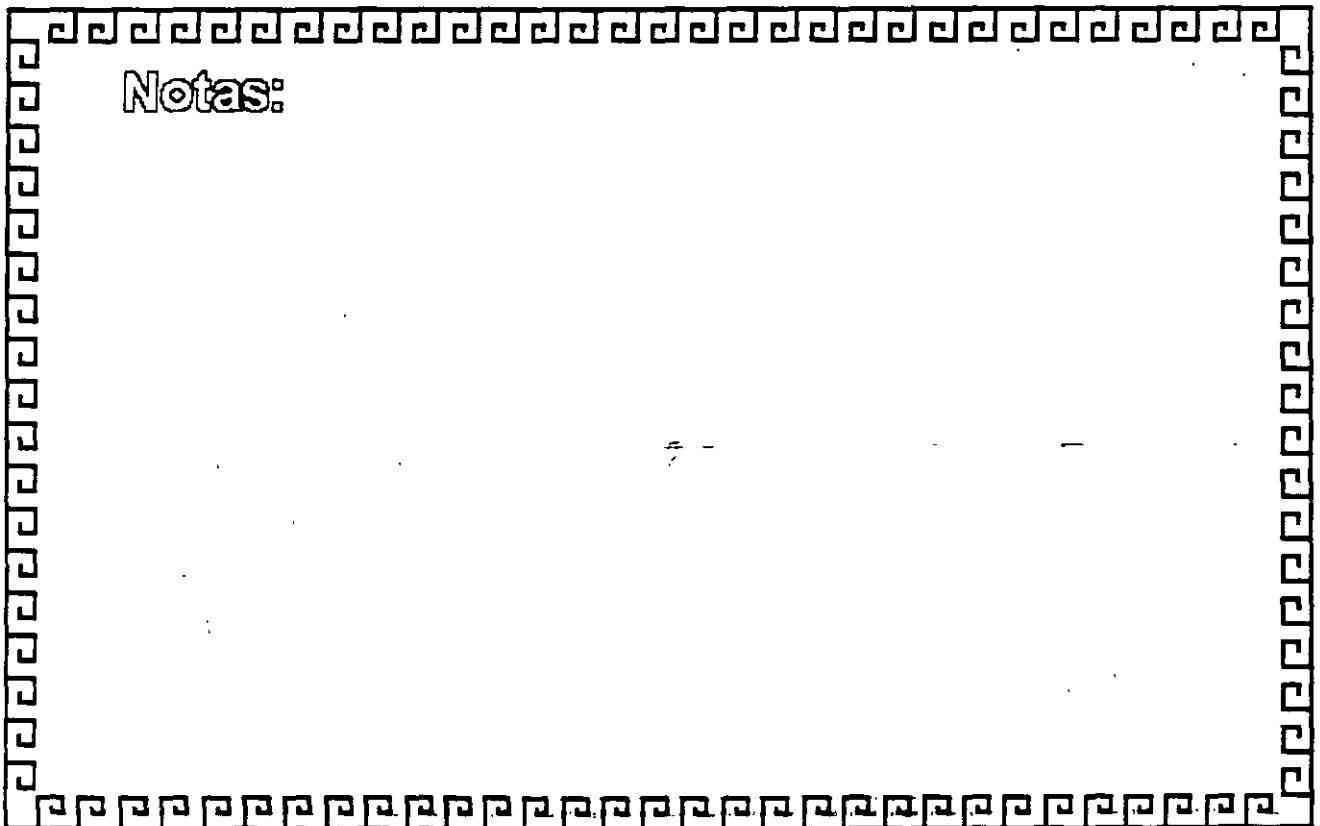



CABLEADO ESTRUCTURADO

¿QUE ES ?

Notas:



DEFINICION

Es el diseño, la instalación y las pruebas de los medios de comunicación necesarios para satisfacer las necesidades de información de un organismo en su area o areas de trabajo, con la filosofia de minimizar las fallas y ser un sistema totalmente administrable y homoganeo.



Notas:





CABLEADO ESTRUCTURADO

Costo de Inversion de Red

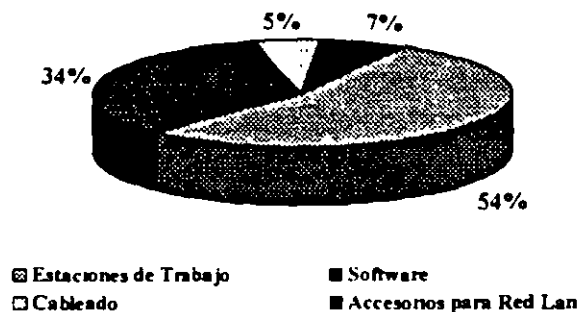

Notas:



CABLEADO ESTRUCTURADO

Tiempo Improductivo en Redes de Computadoras



Notas:

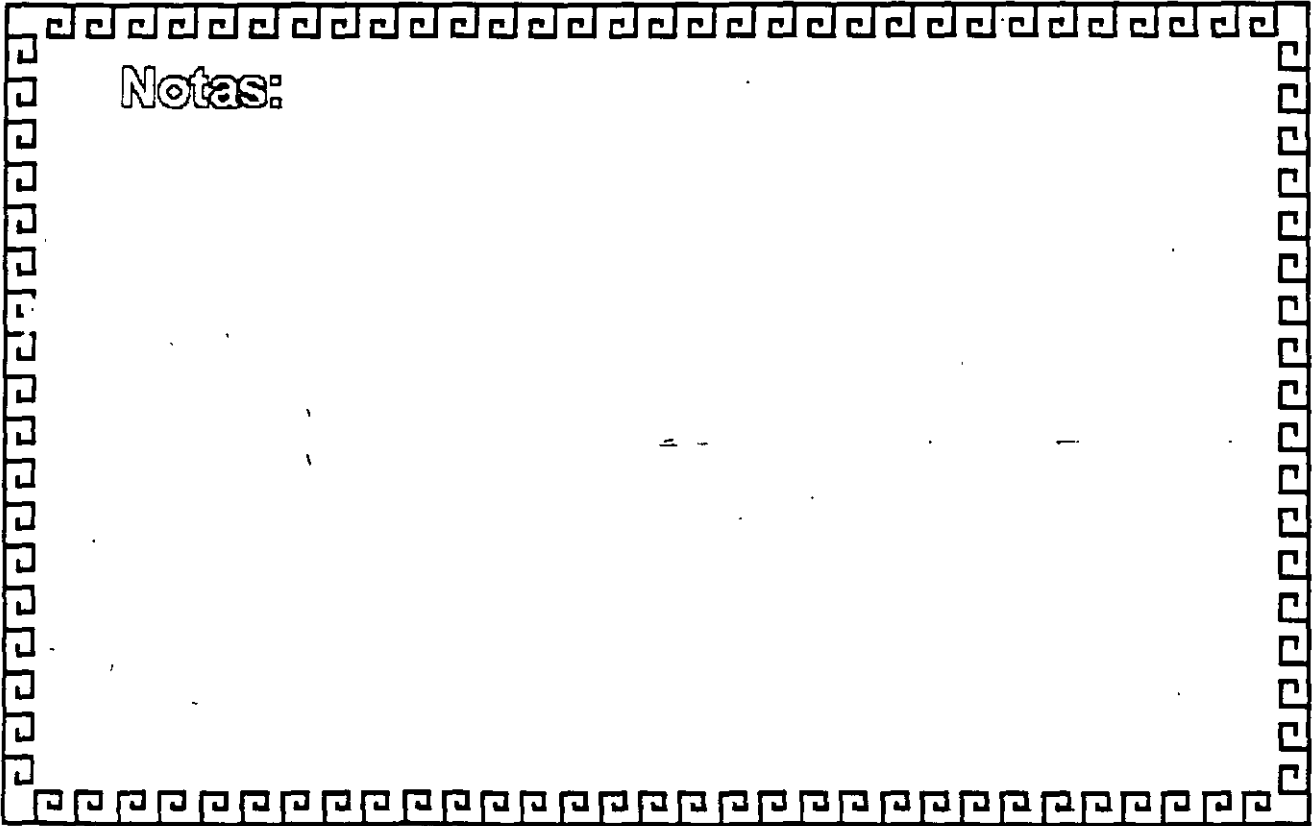



ANTECEDENTES

En todos los sectores de actividad empresas y organizaciones publicas y privadas recurren cada vez más a la informatica y a las tecnicas de telecomunicaciones.

La orientación de las herramientas informaticas modernas esta dada hacia las redes de transmisión de información: voz, datos, texto, video e imágenes.

Notas:



ANTECEDENTES

El increíble aumento de la demanda de Sistemas de telecomunicaciones para las empresas ha puesto de manifiesto la creciente necesidad de dotar a nuestros edificios de un autentico Sistema Nervioso: Confiable, Economico y Ampliable.



Notas:

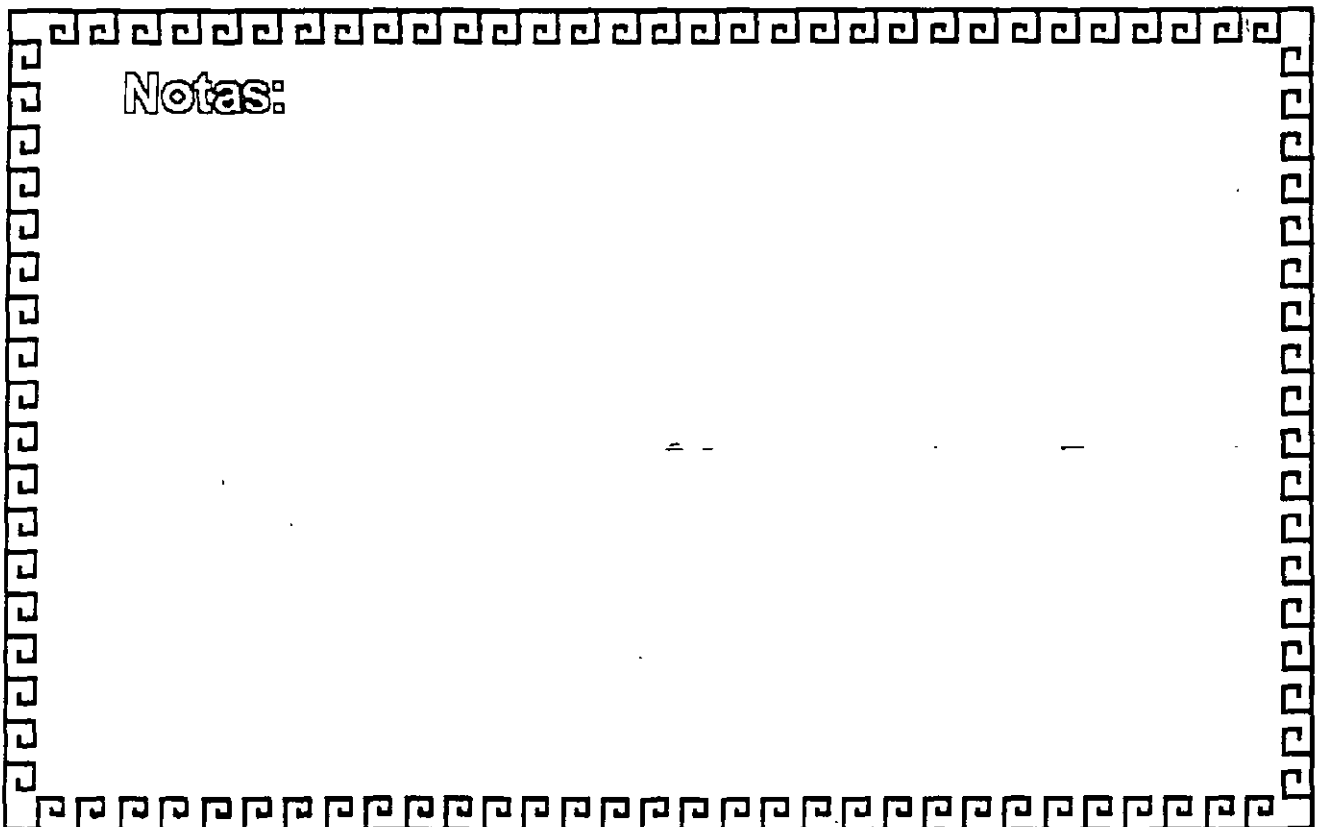



VENTAJAS

- ✓ Administración.
- ✓ Confiabilidad
- ✓ Minimizar fallas en los SI
- ✓ Reconfiguración inmediata
- ✓ Servicios multipropósitos
- ✓ Multimedia
- ✓ Soporte a nuevas tecnologías
- ✓ Independencia de la tecnología y marcas de los equipos a interconectar

Notas:



JUSTIFICACIONES

- ✓ Inversión a largo plazo
- ✓ Amortización a corto plazo
- ✓ Elevar el valor del inmueble
- ✓ Inversión en la infraestructura de información de una empresa
- ✓ Confiabilidad en los SI
- ✓ Elemento necesario para obtener certificaciones de calidad
- ✓ Buen negocio



Notas:

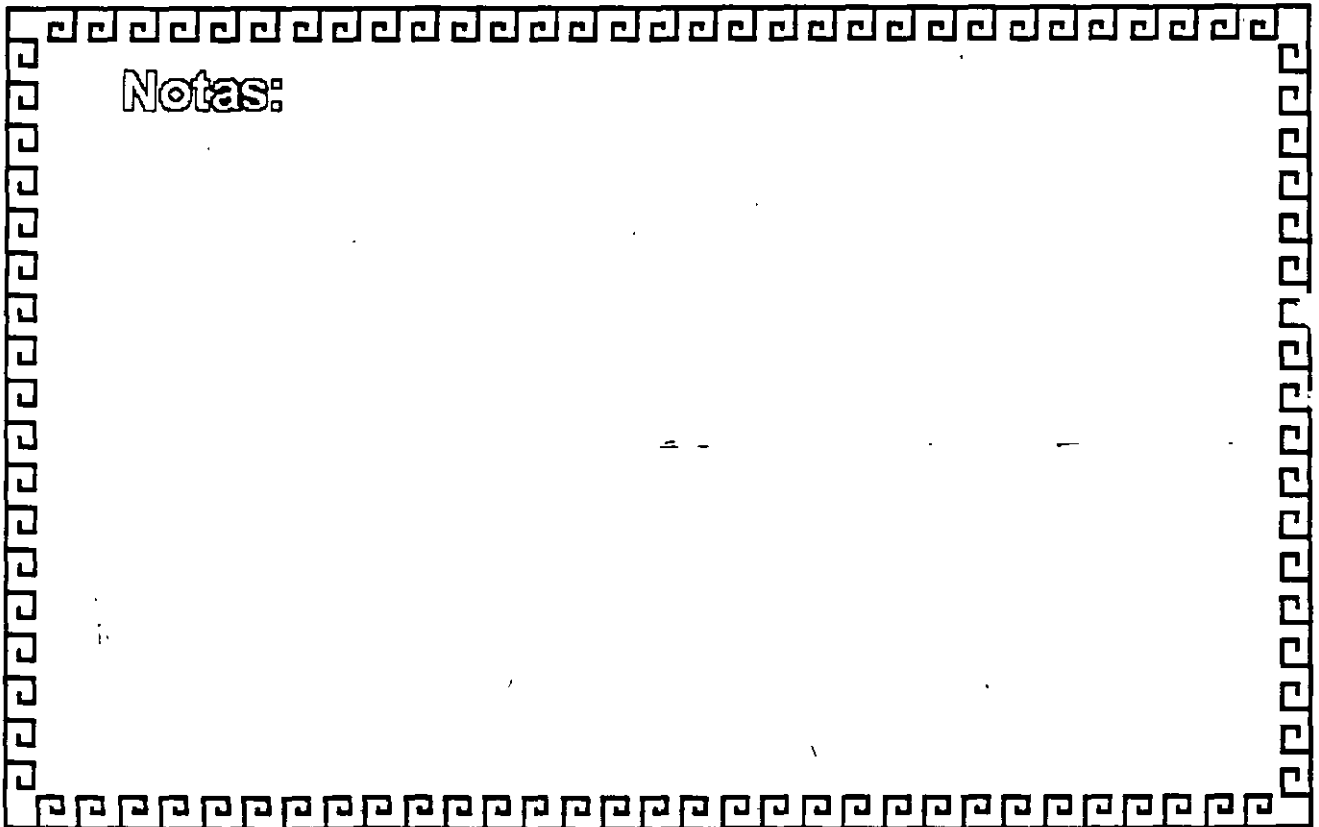



CABLEADO ESTRUCTURADO

CONCEPTOS

Notas:



CABLEADO ESTRUCTURADO

Soluciones completas para

- Voz
- Dato
- Video



Notas:

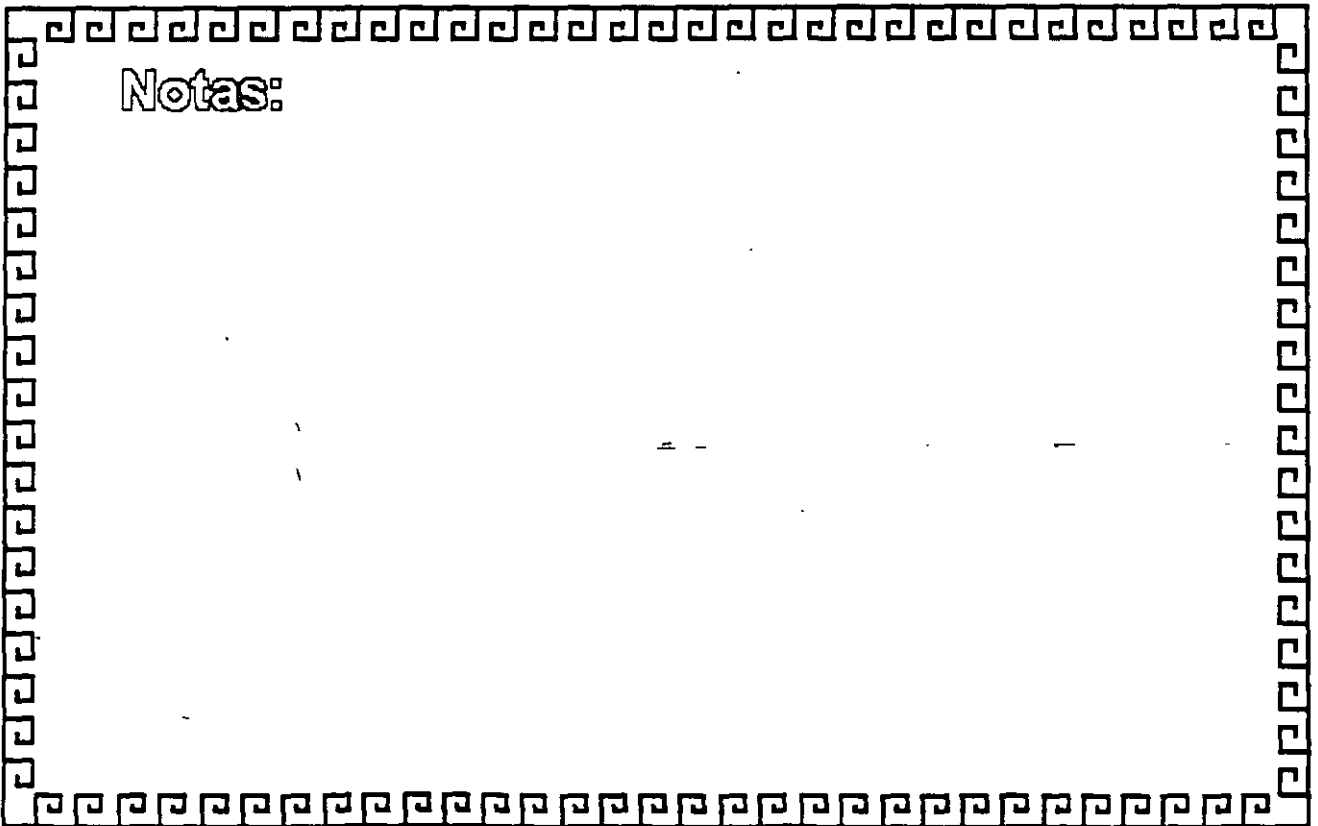



CABLEADO ESTRUCTURADO

ENFOQUE TRADICIONAL

- Instalación de cables específicos al tipo de servicio
- Nueva instalación de cables al modificar o ampliar las áreas de trabajo
- Periodo de instalación largo
- Interrupción temporal del sistema al realizar modificaciones

Notas:



CARACTERISTICAS DE UN SISTEMA DE CABLEADO ESTRUCTURADO

- Infraestructura común para todos los servicios con requerimientos básicos
- La infraestructura inicial incluye posibles ampliaciones o modificaciones de las áreas de trabajo sin necesidad de instalar más cables



Notas:

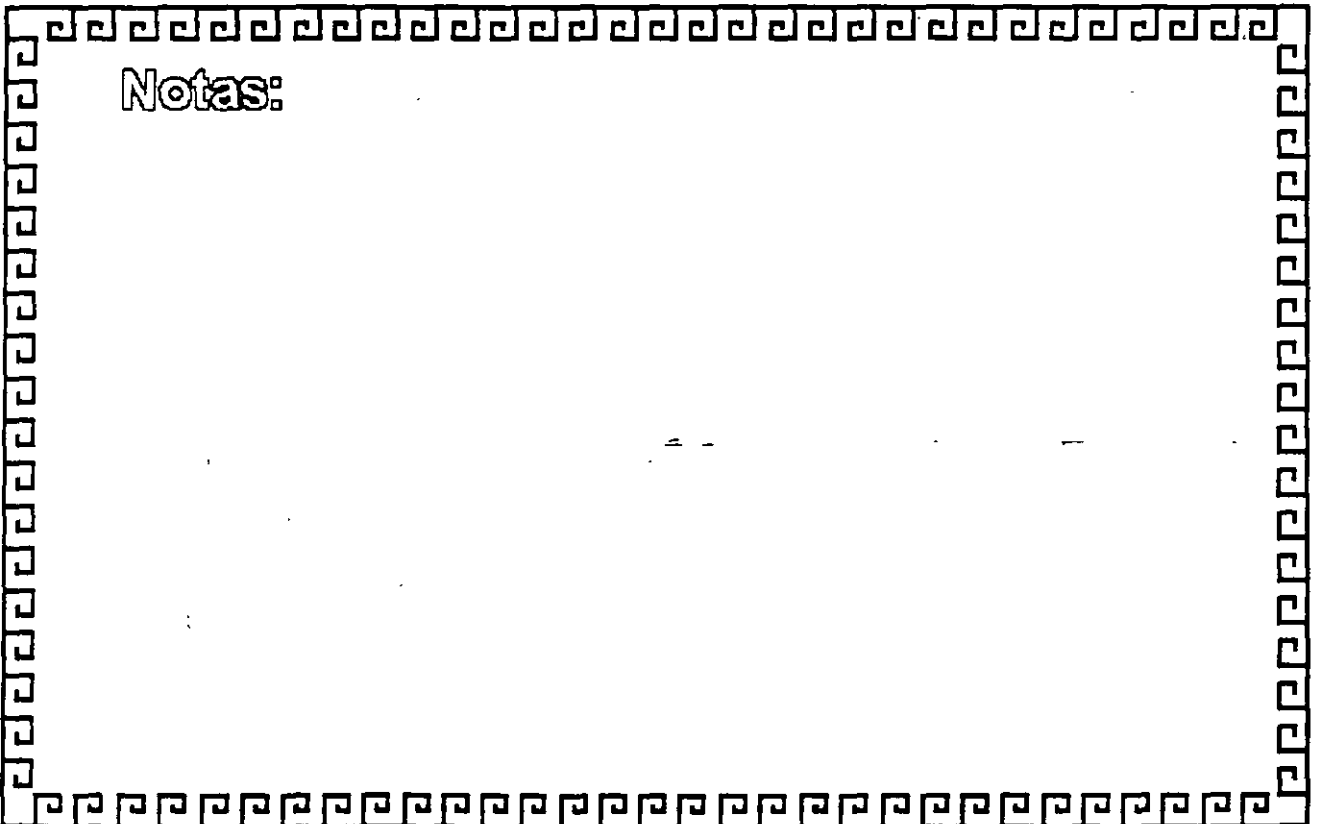



REQUERIMIENTOS DE UN SISTEMA DE CABLEADO ESTRUCTURADO

- Todos los elementos deben cumplir con iguales o superiores requerimientos
- Deben de instalarse y utilizarse adecuadamente
- La reconfiguración consta de operaciones sencillas y es inmediata
- En la mayoría de los casos no se requiere interrumpir el sistema, y si fuese necesario hacerlo, es durante un intervalo de tiempo pequeño

Notas:



BENEFICIOS

Los beneficios que se obtienen

- Inversión recuperable y redituable a mediano plazo
- Facilidad de mantenimiento
- Flexibilidad, al no estar sujeto a marcas.

Notas:



CONCEPTOS

Administración: el método para etiquetado, identificación, documentación y uso necesario para implantar movimientos, adiciones y cambios en la Infraestructura de Telecomunicaciones. (CIC NMX-I-248-1998-NYCE 394)



Notas:

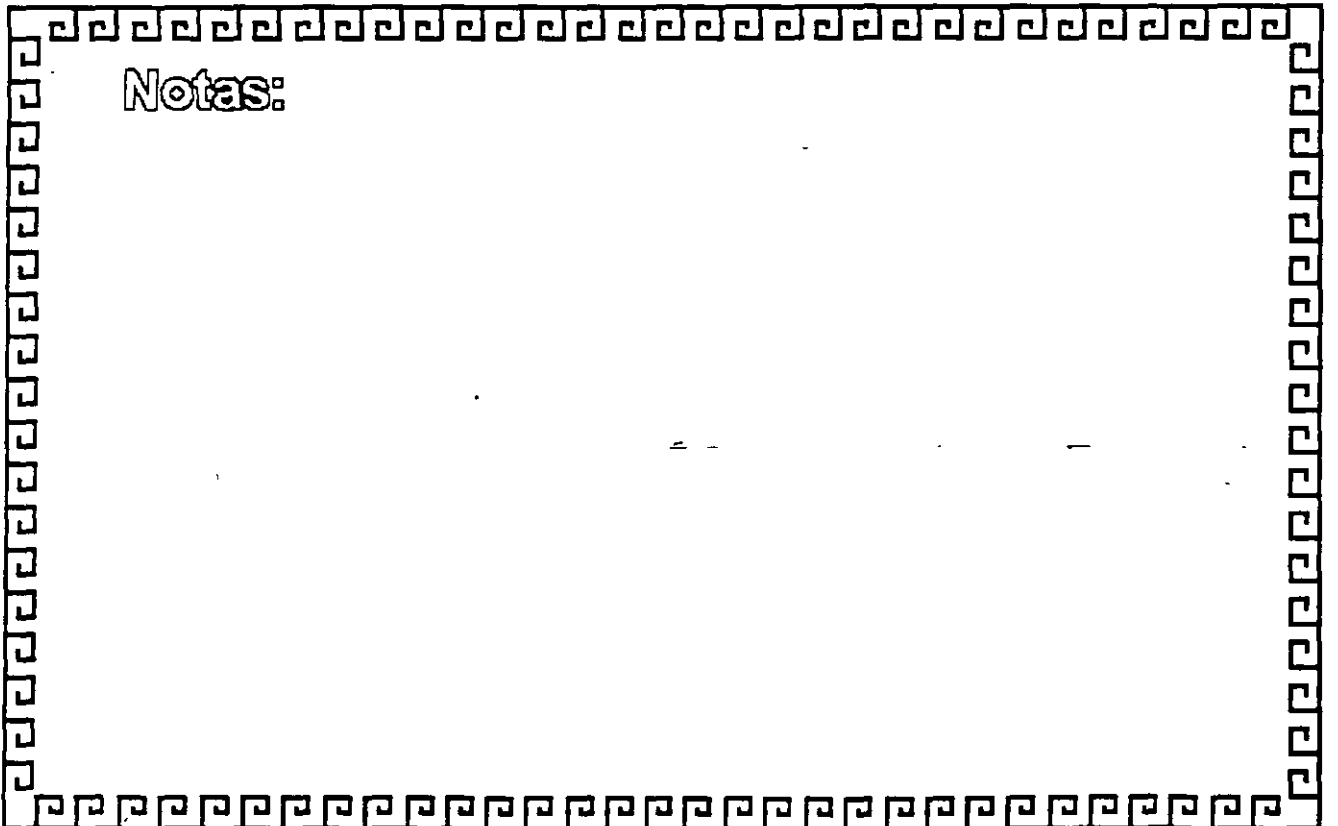



NORMAS

•NORMAS INTERNACIONALES

En el plano internacional, el comité ejecutivo
ISO/IEC/JTC1/CS25 WG3 ha emitido
CABLEADO GENERAL PARA LOCALES DE CLIENTE,
con referencia ISO/IEC 11801



Notas:

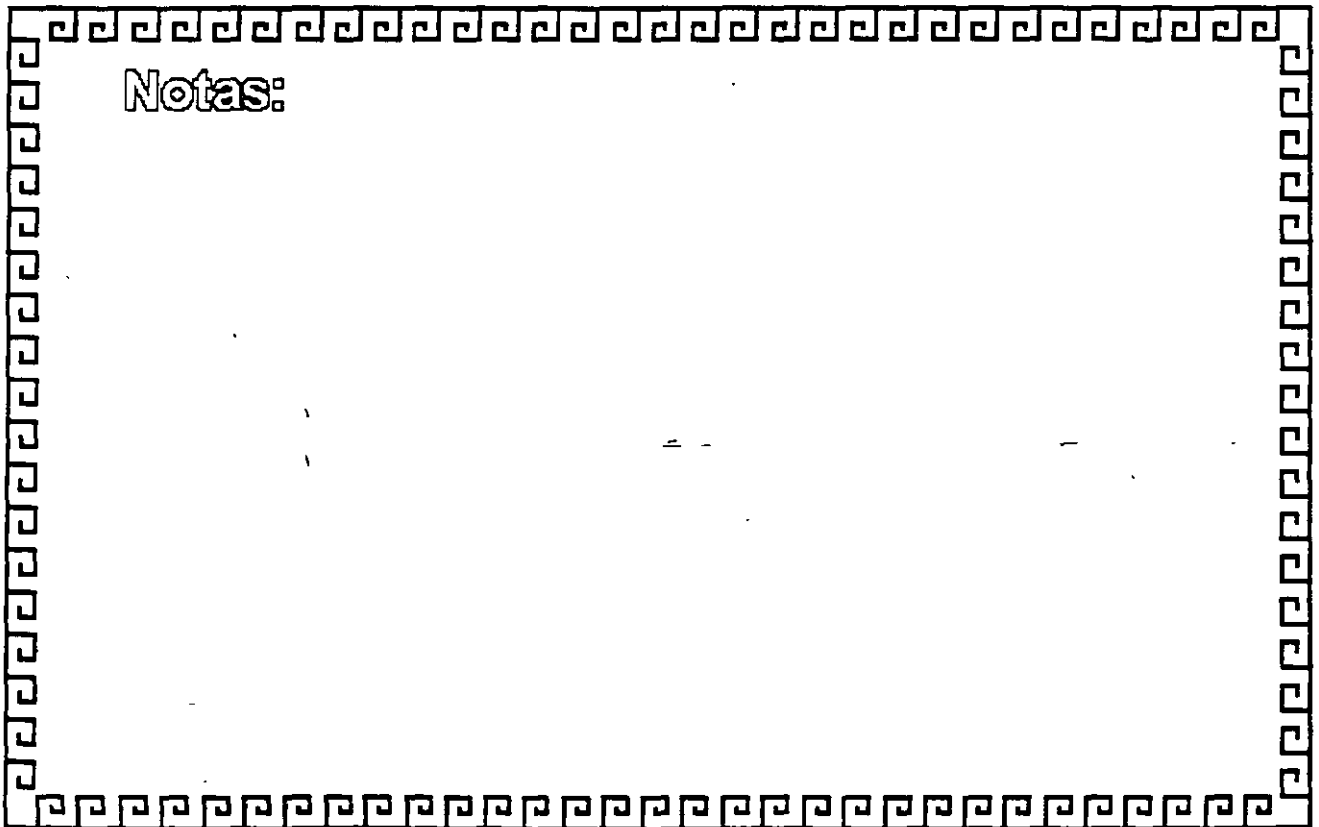



NORMAS

•NORMAS AMERICANAS

En Estados Unidos, la EIA /TIA (Asociación de industrias electrónicas Asociación de industrias de telecomunicaciones) ha emitido normas referentes a:

- cables de distribución horizontal en el documento TSB 36 (Technical System Bulletin 36)
 - tomas murales en el documento TSB 40
 - diseño y aprobación de una cadena de enlace en el documento TSB 67
- 



Notas:



NORMAS

•NORMAS EUROPEAS

En el plano europeo, el CENELEC ha emitido normas basadas parcialmente en las normas ISO/IEC 11801

- Norma EN 50167 (cables de distribución)
- Norma EN 50168 (cables de parcheo y terminales)
- Norma EN 50169 (cables de distribución vertical)
- Norma EN 50173 (Cadena de enlace)
- Proyecto de norma prEN50174 (normas de instalación)



Notas:

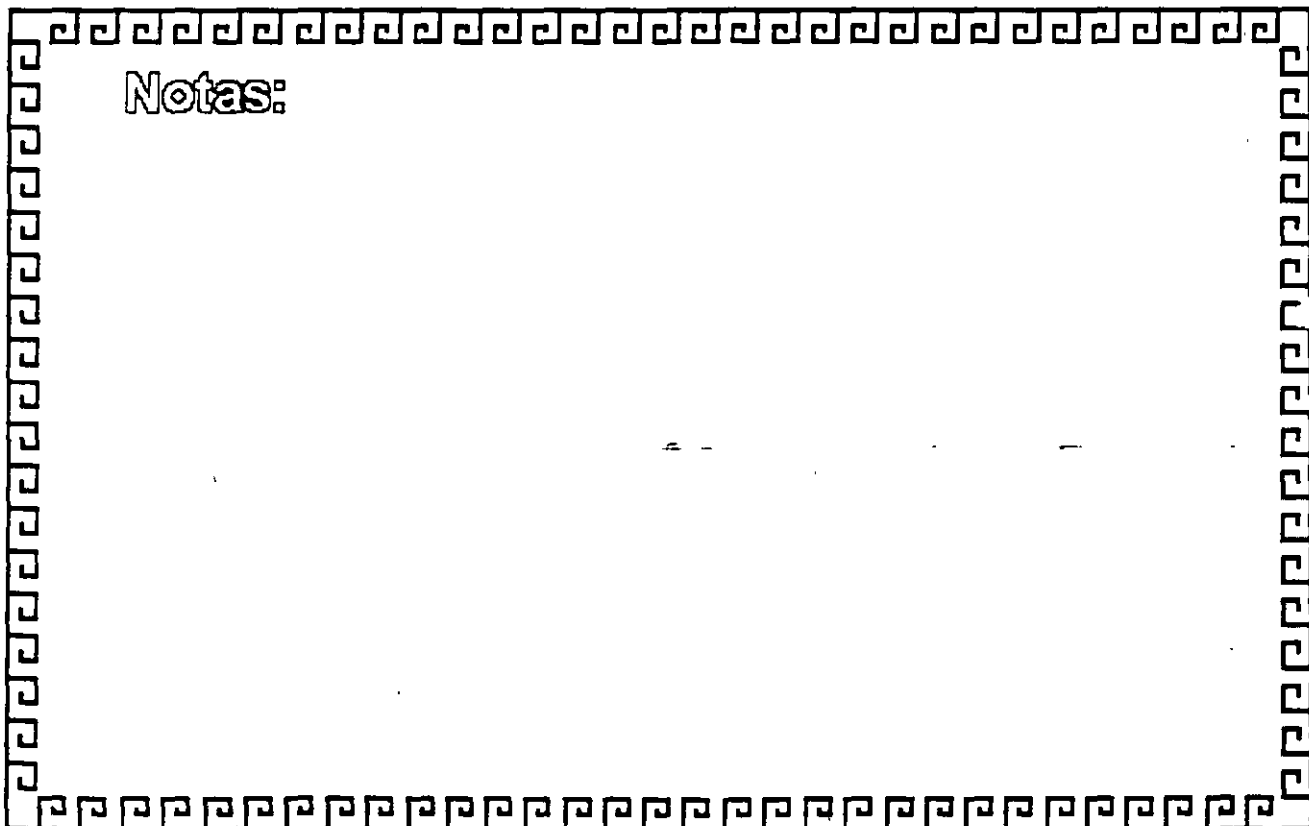



NORMAS

- **NORMA MEXICANA**

PREFACIO

a) La presente norma Mexicana fue elaborada en el seno del Comité Técnico de Normalización Nacional de Telecomunicaciones de NYCE y aprobada por las siguientes Instituciones y Empresas:

- DIRECCION GENERAL DE NORMAS (SECOFI)
- COMISION FEDERAL DE TELECOMUNICACIONES (SUBDIRECCION DE FOMENTO DE LOS SERVICIOS)
- PROCURADURIA FEDERAL DEL CONSUMIDOR
- UNIVERSIDAD NACIONAL AUTONOMA DE MEXICO

Notas:



NORMAS

- **NORMA MEXICANA**

- ASOCIACION MEXICANA DE ESTUDIOS PARA LA DEFENSA DEL CONSUMIDOR
 - CAMARA NACIONAL DE LA INDUSTRIA ELECTRONICA, TELECOMUNICACIONES E INFORMATICA
 - CAMARA NACIONAL DE LA INDUSTRIA HULERA
 - SISTEMA NACIONAL DE ACREDITAMIENTO DE LABORATORIOS DE PRUEB, RAMA ELECTRICA-ELECTRONICA
 - SOLUCIONES INTEGRALES PARA OFICINAS, S.A. DE C.V.
 - RETO INDUSTRIAL, S.A. DE C.V.
- 



Notas:



NORMAS

- **NORMA MEXICANA**

- DIGITER, S.A. DE C.V.
- MX TELECOMUNICACIONES, S.A. DE C.V.
- NORDX /CDT INC. (MEXICO)
- TELEFONOS DE MEXICO, S.A. DE C.V.
- POUYRT MEXICO, S.A. DE C.V.
- STAFF 84, S.A. DE C.V.
- ENLACE DE DATOS, S.A. DE C.V.
- PANDUIT MEXICO, S EN N C DE C.V.

Notas:



NORMAS

- **NORMA MEXICANA**

b) La declaratoria de la vigencia de esta Norma Mexicana, se publicó en el diario Oficial de la Federación el : **8 de enero de 1999**

Y entra en vigor el **8 de marzo de 1999**

Notas:



TECNOLOGIAS

Fabricantes

- POUYET
- LUCENT TECHNOLOGY
- AMP
- KRONE
- BELDEN
- PANDUIT



Notas:

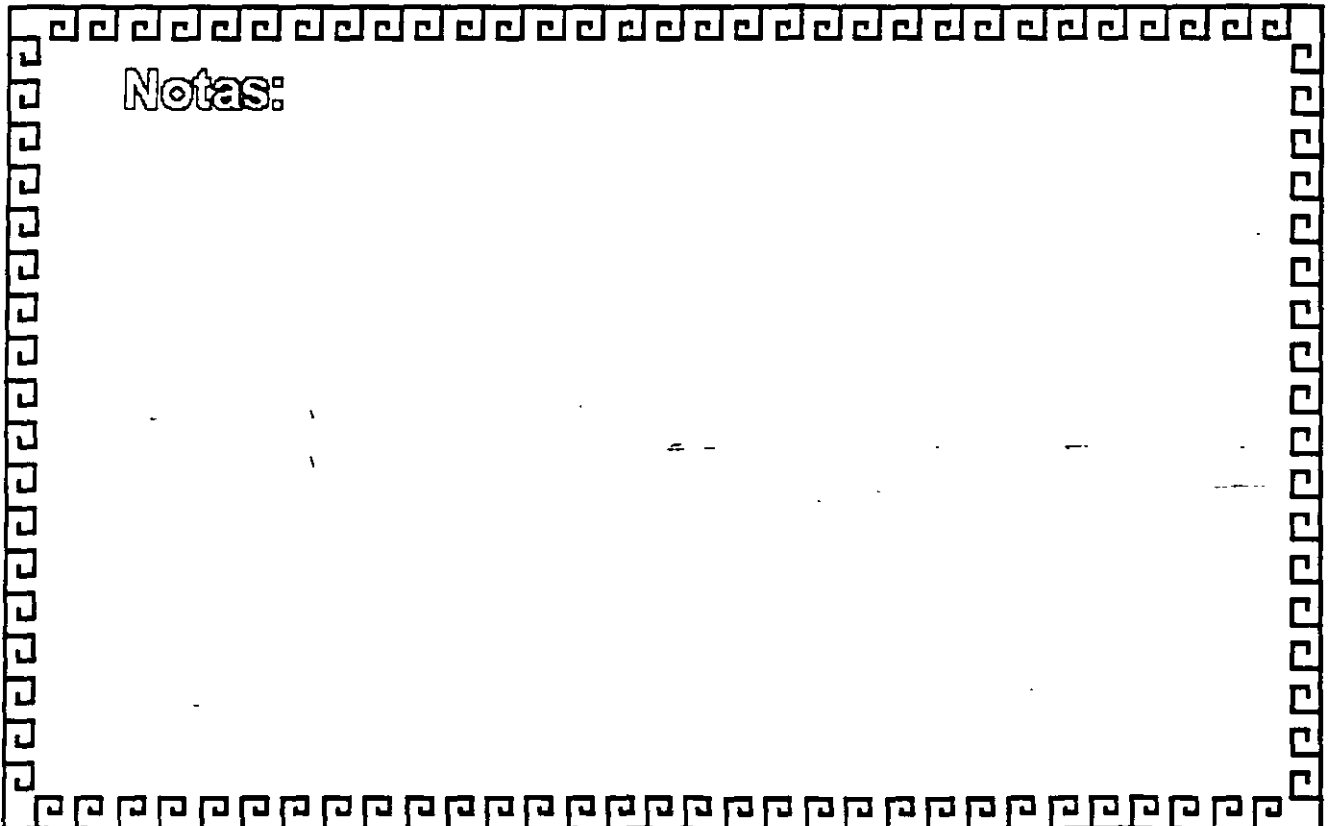



TECNOLOGIAS

FABRICANTE	TECNOLOGIA
<i>POUYET</i>	SCP (Sistema de Cableado polivalente)
<i>KRONE</i>	IDC (Contacto por Desplazamiento de Aislamiento)
<i>PANDUIT</i>	PAN-NET (Network Cabling Systems) PAN-WAY (Surface Receway Systems) PAN-CODE (Network Identification Products)



Notas:

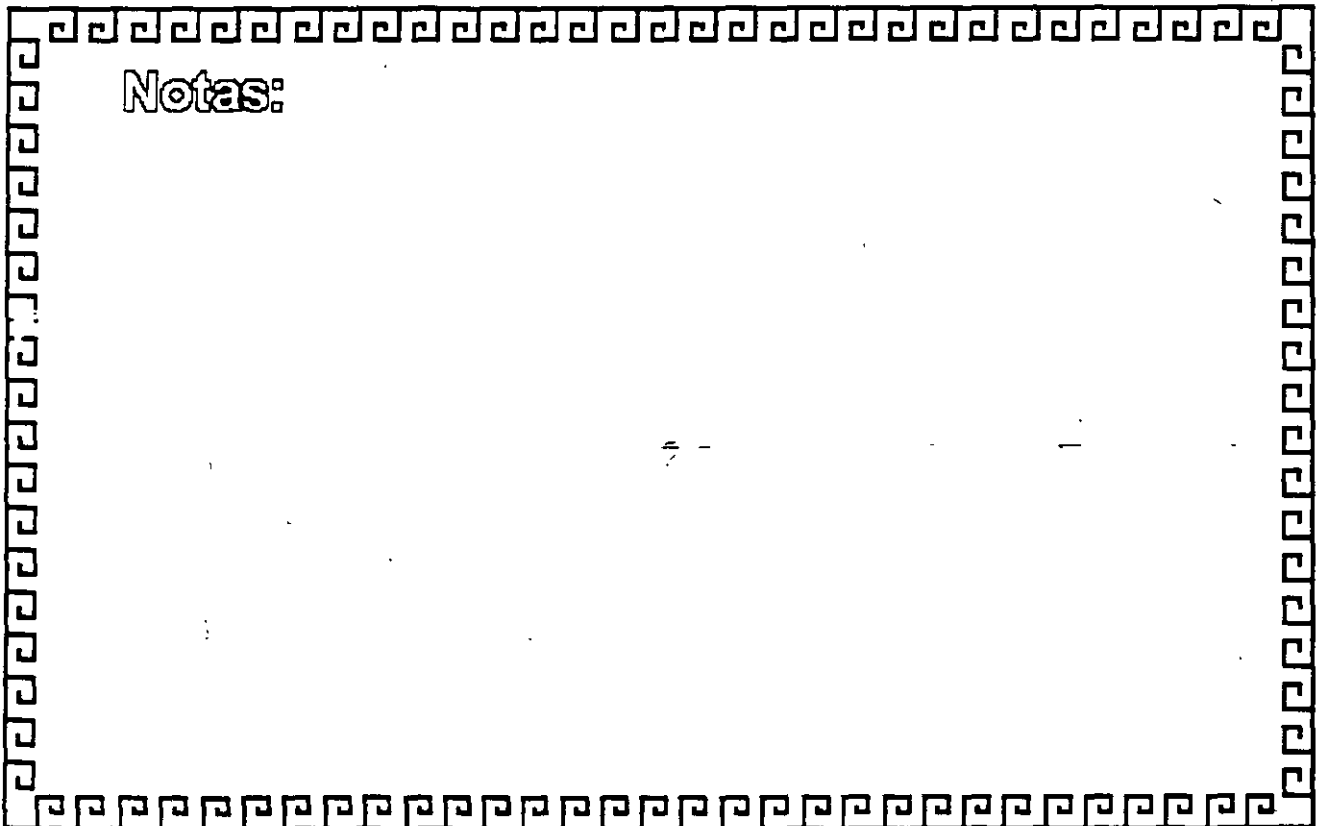

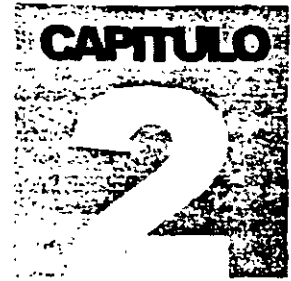

DIPLOMADO EN REDES DE
COMPUTADORAS (LAN, WAN Y GAN)

CABLEADO ESTRUCTURADO
(INGENIERIA Y CERTIFICACION)

Tecnología de Redes y
Medios de Comunicación -

ESTANDARES Y NORMAS EN EL CABLEADO ESTRUCTURADO

Este sistema se basa en la norma EIA/TIA 568b para edificios, normando todos sus componentes a esta norma. El bloque de conexión básico es el 110, desarrollado por "Bell Laboratorios", este bloque creado especialmente tiene varias ventajas y características entre las que se cuentan: alta densidad, reutilización al aceptar más de 10,000 conexiones en el mismo lugar sin afectar el comportamiento; no existe ningún tipo de conductor expuesto después de instalado, evitando así el riesgo de probables cortos circuitos accidentales y/o degradación por oxidación de metales expuestos.

El citado bloque es la base para la conexión y administración del sistema, facilitando esta al no tener diversidad de productos y conectores. Siguiendo con los estándares cada salida de información (roseta) debe contener un conector Rj-45, el cual es un jack de tipo telefónico de 4 pares (8 hilos), es precisamente por contar con 4 pares por lo que se puede garantizar compatibilidad con cualquier sistema existente en el mercado.

Ya que se cuenta con salidas RJ-45, se corren cables de cuatro pares del cuarto de alambrado a cada roseta, este cable de cuatro pares puede ser de nivel 3 con una velocidad de hasta 10 MBPS o nivel 5 para velocidades de transmisión de hasta 100 MBPS. Cada uno de los cuatro pares con los que cuenta el cable, tiene una función específica, empleándose el primer par para servicios de voz, los pares 2 y 3 para servicios de datos y el último par para señales de control de baja potencia.

Además de tener normado el cable de cobre, la fibra óptica está normada de igual forma, utilizando fibra multimodo de 62.5/125 micrones, conectorizado con conectores ST-JI, el empleo de esta fibra obedece a que las distancias dentro de un predio no justifican el empleo de fibra unimodo, máxime que la electrónica asociada a esa fibra, es mucho más costosa que la electrónica para fibra multimodo.

En este apartado se determinan las características de un sistema de cableado estructurado para establecer las especificaciones técnicas del presente documento.

Los sistemas que conforman un cableado estructurado son los siguientes:

SUBSISTEMA ESTACIÓN DE TRABAJO

Este subsistema contempla todos los adaptadores necesarios para conectar el equipo del usuario a la salida de información, logrando aquí la conexión física a cualquier teléfono, computadora o terminal de la red de cableado.

SUBSISTEMA HORIZONTAL

Aquí se contempla el cableado que corre de cada salida de información (roseta), al cuarto de alambrado de piso (IDF), se cuenta con diferentes cables y componentes para adecuarse a los requerimientos de los niveles de sistema, esto es, se cuenta con cables de nivel 3 para sistemas telefónicos y/o de cómputo que transmitan a velocidades menores a 10 MBPS y con cable nivel 5 para sistemas que requieren velocidades de comunicación de hasta 100 MBPS.

En este subsistema se incluyen las salidas de información, rosetas que van de

Acuerdo con el cable y velocidad requerida para ello.

SUBSISTEMA VERTICAL

Este subsistema contempla la comunicación necesaria entre cada piso (IDF'S) y el distribuidor principal (MDF) Este enlace se logra mediante el uso de cable multipar o bien con Fibra Optica dependiendo de los requerimientos de velocidad que se tengan.

SUBSISTEMA DE ADMINISTRACIÓN

Aqui convergen los subsistemas vertical y horizontal, siendo el lugar donde se logra la interconexión de ambos subsistemas. En el también radica una de las principales virtudes del sistema que es el etiquetado, cada uno de los sistemas quedan perfectamente identificados con un color característico, de manera que los cambios y movimientos que se soliciten, se podrán hacer en unos minutos, logrando así abatir importantemente los gastos de administración y mantenimiento de la red de comunicaciones.

SUBSISTEMAS DE CUARTO DE EQUIPO

Este es el punto central de administración y control del sistema, donde se aloja normalmente el distribuidor principal del cableado estructurado con el PBX, el sistema central de proceso de datos (MAIN FRAME), y/o el punto neurálgico de administración de las redes locales (LAN), y distribuir las señales en toda la red, empleando la fibra óptica y el cable de par trenzado sin blindar UTP existentes en los otros subsistemas.

SUBSISTEMA CAMPUS

Este subsistema contempla la interconexión de diferentes edificios dentro de un mismo predio, empleando fibra óptica y/o cable multipar especialmente diseñado para instalarse en exteriores.

Como se observa, la definición precisa de cada subsistema, es acorde con el concepto de modularidad, garantizando la independencia de cada uno de ellos, de tal suerte que al diseñar este sistema, se pueda hacer por partes que se puedan integrar y conformar un sistema completo, es por ello que se puede diseñar e instalar este sistema por módulos o secciones y/o en forma integral.



Ethernet Media

This chapter examines the physical characteristics and requirements of both physical cabling and the connectors and ports used with the cabling in Ethernet, Full-Duplex Ethernet, and Fast Ethernet environments.

Cabling Types

Attachment Unit Interface (AUI)

Attachment Unit Interface cable (referred to hereafter as AUI cable) is a shielded, multistranded cable that is used to connect Ethernet network devices to Ethernet transceivers. AUI cable should be used for no other purpose. AUI cable is available in two basic types: standard AUI and office AUI.

AUI cable is made up of four individually shielded pairs of wire surrounded by an overall cable shielding sheath. The doubled shielding makes AUI cable more resistant to electrical signal interference than other, lighter cables, but increases the signal attenuation suffered over long distances.

AUI cables are connected to other devices through DB15 connectors. The connectors of an AUI cable run from Male to Female at all times. Any transceiver cable that uses a Male/Male or Female/Female configuration is a non-standard cable, and should be avoided.

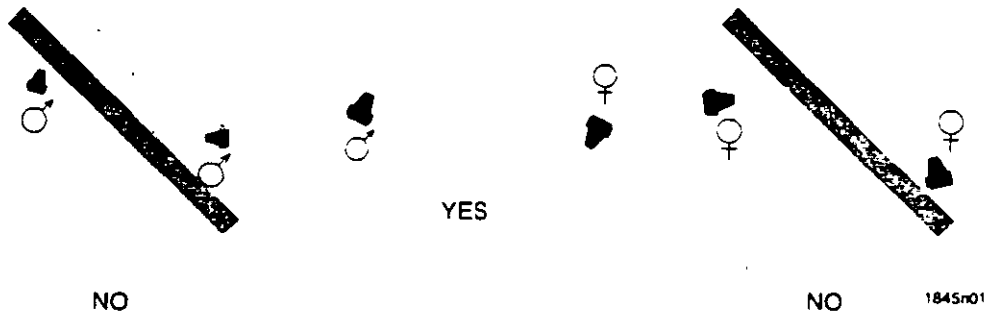

Figure 4-1. AUI Cable Configurations

The reason for the configuration of AUI cables as Male to Female only is due to their intended use. AUI cables are designed to attach transceivers to workstations or other active network equipment. Transceivers require power to operate, and that power is supplied either by an external power supply or by a pair of wires dedicated to power in the cable. A Male/Male or Female/Female AUI cable does not correctly supply power and grounding to the transceiver. If you use a Female/Female AUI cable between two transceiver devices, both transceivers will try to draw power from each other. Neither is capable of providing this power. Therefore, this configuration will not function. Likewise, two AUI device ports should never be directly attached without using transceivers.



If you find yourself in need of a gender changer to connect a device with AUI cable, you are doing something wrong.

Standard

The gauge of the internal wires that make up the cable determines the thickness and relative flexibility of the AUI cable. Standard AUI cable (containing pairs of AWG 20 or 22 wire) is capable of reaching a maximum distance of 50 meters between transceivers and the network device, but is thick, (0.420 inch) and somewhat inflexible.

Standard AUI cables, due to their bulk, are typically used in environments that require the 50 meter distances that standard AUI cables can provide. In situations where the workstations or networking equipment are close to the transceivers they are to be connected to, Office AUI cable, being more easily managed and more flexible, is often used.

Office

Office AUI cable is a thinner cable that is more convenient to use on many environments than standard AUI. This lighter-gauge AUI cable is made up of four pairs of AWG 28 wire, which is thinner (at 0.26 inch) and much more easily flexed, but can only be run to a maximum distance of 16.5 meters.

Office AUI cable is intended to be used in places where standard AUI cable would be cumbersome and inflexible. Typically, office AUI is used in locations where a large number of workstations are concentrated in a single area.

Coaxial Cable

Coaxial cable is a cabling type where two or more separate materials share a common central axis. While several types of networking cables could be identified as having coaxial components or constructions, there are only two cable types that can support network operation using only one strand of cabling with a shared axis. These are commonly accepted as the coaxial cables, and are divided into two main categories: thick and thin coaxial cable.

Thick Coaxial Cable

Thick coaxial cable (also known as thick Ethernet cable, "thicknet," or 10BASE5 cable), is a cable constructed with a single solid core, which carries the network signals, and a series of layers of shielding and insulator material. The shielding of thick coaxial cable consists of four stages. The outermost shield is a braided metal screen. The second stage shield, working inward, is usually a metal foil, but in some brands of coaxial cable may be made up of a second screen. The third stage consists of a second braided shield followed by the fourth stage, a second foil shield. The various shields are separated by non-conductive insulator materials.

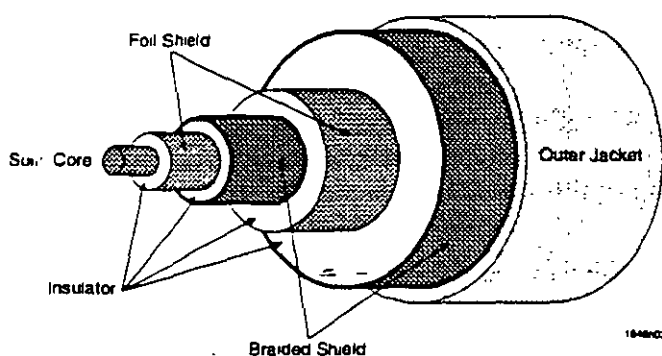

Figure 4-2. Thick Coaxial Cable Diagram

Thick coaxial cable is a media used exclusively in Ethernet installations, commonly as a backbone media. Transceivers are connected to the cable at specified distances from one another, and standard transceiver cables connect these transceivers to the network devices.

Due to the extensive shielding, thick coaxial cable is highly resistant to electrical interference by outside sources such as lighting, machinery, etc. Because of the bulkiness (typically 0.405 inch in diameter or thicker) and limited flexibility of the cable, thick coaxial cable is primarily used as a backbone media and is placed in cable runways or laid above ceiling tiles to keep it out of the way.

Thick coaxial cable is designed to be accessed as a shared media. Multiple transceivers can be attached to the thick coaxial cable at multiple points on the cable itself. A properly installed length of thick coaxial cable can support up to 100 transceivers.

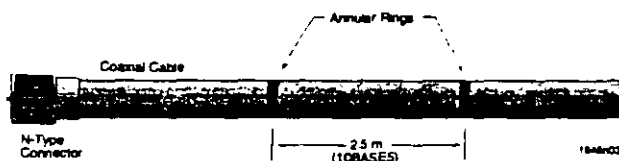

Figure 4-3. Annular Rings

Multiple transceivers on a thick coaxial cable must be spaced at least 2.5 meters from any neighboring transceivers or terminators. Thick coaxial cable is often bright yellow or orange in color. The outer jacket will frequently be marked with annular rings, dark red or black sections of jacketing that are spaced 2.5 meters from one another. These annular rings are a useful guide for ensuring that terminators and transceivers are spaced not less than 2.5 m from one another.

Thin Coaxial Cable

Thin coaxial cable (also known as thin Ethernet cable, "thinnet," "cheapernet," RG-58 A/U, BNC or 10BASE2 cable) is a less shielded, and thus less expensive, type of coaxial cabling. Also used exclusively for Ethernet networks, thin coaxial cable is smaller, lighter, and more flexible than thick coaxial cable. The cable itself resembles (but is not identical to) television coaxial cable.

Thin coaxial cable is made up of a single outer copper shield that may be braided or foil, a layer beneath that of non-conductive dielectric material, and a stranded center conductor. This shielding makes thin coaxial cable resistant to electromagnetic interference as the shielding of thick coaxial cable does, but does not provide the same extent of protection. Thin coaxial cable, due to its less extensive shielding capacity, can be run to a maximum length of 185 meters (606.7 ft).

Building Network Coax (BNC) connectors crimp onto a properly prepared cable end with a crimping tool. To prevent signal reflection on the cable, 50 Ohm terminators are used on unconnected cable ends.

As with thick coaxial cable, thin coaxial cable allows multiple devices to connect to a single cable. Up to 30 transceivers may be connected to a single length of thin coaxial cable, spaced a minimum of 0.5 meter from one another. This minimum spacing requirement keeps the signals from one transceiver from interfering with the operation of others. The annular rings on the thin coaxial cable are placed 0.5 meter apart, and are a useful guide to transceiver placement.

Unshielded Twisted Pair (UTP)

Unshielded Twisted Pair cabling (referred to here as UTP, but also may be termed copper wire, 10BASE-T wire, Category 3, 4, or 5 Ethernet wire, telephone cable, or twisted pair without shielded or unshielded qualifier) is commonly made up of two, four, or 25 pairs of 22, 24, or 26 AWG unshielded copper solid or stranded wires. These pairs of wires are twisted together throughout the length of the cable, and are broken up into transmit and receive pairs. In each pair, one wire carries the normal Ethernet transmission, while its associated wire carries a copy of the transmission that has been inverted.

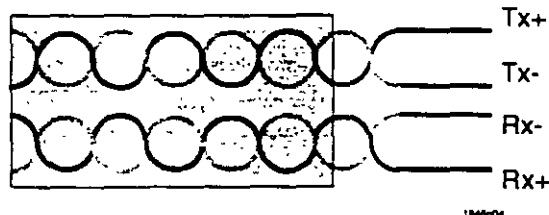

Figure 4-4. UTP Cable Pair Association

The twisting of associated pairs helps to reduce the interference of the other strands of wire throughout the cable. This is due to the method of transmission used with twisted pair transmissions.

In any transceiver or Network Interface Card (NIC), the network protocol signals to be transmitted are in the form of changes of electrical state. The means by which the ones and zeroes of network communications are turned into these signals is called encoding. In a twisted pair environment, once a transceiver has been given an encoded signal to transmit, it will copy the signal and invert the polarity of that signal (see Figure 4-5). The result of this inverted signal is a mirror opposite of the original signal.

Both the original and the inverted signal are then transmitted, the original signal over the TX+ wire, the inverted signal over the TX - wire. As these wires are the same length and of the same construction, the signal travels (propagates) at the same rate through the cable. Since the pairs are twisted together, any outside electrical interference that affects one member of the pair will have the same effect on the other member of that pair.

The transmissions travel through the cable, eventually reaching a destination transceiver. At this location, both signals are read in. The original signal is unchanged, but the signal that had previously been inverted is reverted to the original state. When this is done, it returns the encoded transmission to its original state, but reverses the polarity of any signal interference that the encoded transmission may have suffered.

Once the inverted transmission has been returned to the normal encoded state, the transceiver adds the two signals together. As the encoded transmissions are now identical, there is no change to the data content. Line noise spikes, however, are combined with noise spikes of their exact opposite polarity, causing them to cancel one another out.

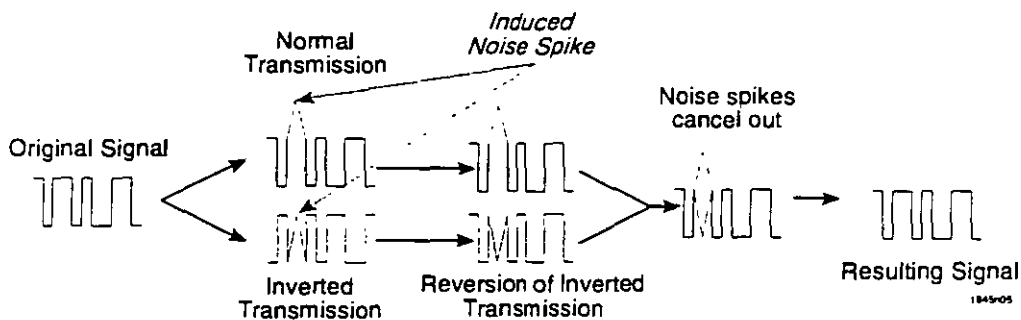

Figure 4-5. UTP Signal Equalization

The UTP cable used in network installations is the same type of cable used in the installation of telephone lines within buildings. UTP cabling is differentiated by the quality category of the cable itself, which is an indicator of the type and quality of wire used and the number of times the wires are twisted around each other per foot. The categories range from Category 1 to Category 5, with Category 5 cabling being of the highest quality.

The wires that make up a length of UTP cable are numbered and color coded. These color codes allow the installer of the networking cable to determine which wires are connected to the pins of the RJ45 ports or patch panels. The numbering of the wires in EIA/TIA standard cables is based on the color of the insulating jacket that surrounds the core of each wire.

The association of pairs of wire within the UTP cable jacket are decided by the specifications to which the cable is built. There are two main specifications in use around the world for the production of UTP cabling: EIA/TIA 568A and the EIA/TIA 568B. The two wiring standards are different from one another in the way that the wires are associated with one another at the connectors.

The arrangement of the wires in the two EIA/TIA specifications does not affect the usability of either type of connector style for 10BASE-T purposes. As the arrangement of the wires into pairs and the twisting of the pairs throughout the cable remain the same regardless of the EIA/TIA specification being used, the two specifications can be considered equivalent. As the specifications terminate the wires into different arrangements, care must be taken to keep all the cables at a facility terminated to the same EIA/TIA standard. Failure to do so can result in the mis-association of wires at the connectors, making the cabling unable to provide a connection between Ethernet devices. The arrangement of the wires and pairs in the two EIA/TIA specifications is discussed in the **UTP Cable** portion of the **Connector Types** section of this chapter.

Keep in mind that the selection of an EIA/TIA wiring scheme determines the characteristics of Wallplates, Patch Panels, and other UTP interconnect hardware you add to the network. Most manufacturers supply hardware built to both of these specifications. The more common of the two specifications in 10BASE-T applications is EIA/TIA 568A.

Four-Pair Cable

The typical single UTP cable is a polyvinyl chloride (PVC) or plenum-rated plastic jacket containing four pairs of wire. The majority of facility cabling in current and new installations is four-pair cable of this sort. The dedicated single connections made using four-pair cable are easier to troubleshoot and replace than the alternative, bulk multipair cable such as 25-pair cable.

The jacket of each wire in a four-pair cable will have an overall color: brown, blue, orange, green, or white. In a four-pair UTP cable (the typical UTP used in networking installations) there is one wire each of brown, blue, green, and orange, and four wires whose overall color is white. The white wires are distinguished from one another by periodically placed (usually within 1/2 inch of one another) rings of the other four colors.

Wires with a unique base color are identified by that base color: blue, brown, green, or orange. Those wires that are primarily white are identified as white/<color>, where <color> indicates the color of the rings of the other four colors in the white insulator.

The 10BASE-T and 100BASE-TX standards are concerned with the use of two pairs, Pair 2 and Pair 3 (of either EIA/TIA 568 specification). The 10BASE-T and 100BASE-TX standards configure devices to transmit over Pair 3 of the EIA/TIA 568A specification (Pair 2 of EIA/TIA 568B), and to receive from Pair 2 of the EIA/TIA 568A specification (Pair 3 of EIA/TIA 568B). The use of the wires of a UTP cable is shown in Table 4-1.

Table 4-1. 10BASE-T/100BASE-TX Four-Pair Wire Use

Wire Color	EIA/TIA Pair	Ethernet Signal Use	
		568A	568B
White/Blue (W-BL)	Pair 1	Not Used	
Blue (BL)			
White/Orange (W-OR)	Pair 2	RX+	TX+
Orange (OR)		RX-	TX-
White/Green (W-GR)	Pair 3	TX+	RX+
Green (GR)		TX-	RX-
White/Brown (W-BR)	Pair 4	Not Used	
Brown (BR)			

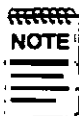

Do not split pairs in a twisted pair installation. While you may consider combining your voice and data cabling into one piece of horizontal facility cabling, the Crosstalk and interference produced by this practice greatly reduces the viability of the cable for either application. The use of the pairs of cabling in this fashion can also prevent the future usage of advanced networking technologies such as FDDI TP-PMD and 100BASE-T4, that require the use of all four pairs in a twisted pair cable.

Twenty-Five Pair Cable

UTP cabling in large installations requiring several cable runs between two points is often 25-pair cable. This is a heavier, thicker form of UTP. The wires within the plastic jacket are of the same construction, and are twisted around associated wires to form pairs, but there are 50 individual wires twisted into 25 pairs in these larger cables. In most cases, 25-pair cable is used to connect wiring closets to one another, or to distribute large amounts of cable to intermediate distribution points, from which four-pair cable is run to the end stations.

As with four-pair cable, the wires within a 25-pair cable are identified by color. The jacket of each wire in a 25-pair cable has an overall color: violet, green, brown, blue, red, orange, yellow, gray, black, and white. In a 25-pair UTP cable all wires in the cable are identified by two colors. The first color is the base color of the insulator, while the second is the color of narrow bands painted onto the base color. These identifying rings are periodically placed on the wire, and repeat at regular intervals. When a wire is identified in a 25-pair cable, it is identified first by its base color, and then further specified by the color of the bands or rings.

As a 25-pair cable can be used to make up to 12 connections between Ethernet stations (two wires in the 25-pair cable are typically not used), the wire pairs need to be identified not only as transmit or receive pairs, but what other pair they are associated with. There are two ways of identifying sets of pairs in a 25-pair cable. The first is based on the connection of a 25-pair cable to a specific type of connector designed especially for it, the RJ21 connector. The second is based on connection to a punchdown block, a cable management device typically used to make the transition from a single 25-pair cable to a series of four-pair cables easier.

For further information on the RJ21 connector, refer to the **Connector Types** section later in this chapter. A description of punchdown blocks may be found in Chapter 13, **Cabling Devices**, and details of the punchdowns may be found in the **Connector Types** section later in this chapter.

Table 4-2. 25-Pair Cable Pair Mapping

Port Number	Wire Use	Wire Color	RJ21 Pin Number	Punchdown In Number	Punchdown Out Number
1	RX +	White/Blue	26	A1	B1
	RX -	Blue/White	1	A2	B2
	TX +	White/Orange	27	A3	B3
	TX -	Orange/White	2	A4	B4
2	RX +	White/Green	28	A5	B5
	RX -	Green/White	3	A6	B6
	TX +	White/Brown	29	A7	B7
	TX -	Brown/White	4	A8	B8
3	RX +	White/Gray	30	A9	B9
	RX -	Gray/White	5	A10	B10
	TX +	Red/Blue	31	A11	B11
	TX -	Blue/Red	6	A12	B12

Table 4-2. 25-Pair Cable Pair Mapping (Continued)

Port Number	Wire Use	Wire Color	RJ21 Pin Number	Punchdown In Number	Punchdown Out Number
4	RX +	Red/Orange	32	A13	B13
	RX -	Orange/Red	7	A14	B14
	TX +	Red/Green	33	A15	B15
	TX -	Green/Red	8	A16	B16
5	RX +	Red/Brown	34	A17	B17
	RX -	Brown/Red	9	A18	B18
	TX +	Red/Gray	35	A19	B19
	TX -	Gray/Red	10	A20	B20
6	RX +	Black/Blue	36	A21	B21
	RX -	Blue/Black	11	A22	B22
	TX +	Black/Orange	37	A23	B23
	TX -	Orange/Black	12	A24	B24
7	RX +	Black/Green	38	A25	B25
	RX -	Green/Black	13	A26	B26
	TX +	Black/Brown	39	A27	B27
	TX -	Brown/Black	14	A28	B28
8	RX +	Black/Gray	40	A29	B29
	RX -	Gray/Black	15	A30	B30
	TX +	Yellow/Blue	41	A31	B31
	TX -	Blue/Yellow	16	A32	B32
9	RX +	Yellow/Orange	42	A33	B33
	RX -	Orange/Yellow	17	A34	B34
	TX +	Yellow/Green	43	A35	B35
	TX -	Green/Yellow	18	A36	B36

Table 4-2. 25-Pair Cable Pair Mapping (Continued)

Port Number	Wire Use	Wire Color	RJ21 Pin Number	Punchdown In Number	Punchdown Out Number
10	RX +	Yellow/Brown	44	A37	B37
	RX -	Brown/Yellow	19	A38	B38
	TX +	Yellow/Gray	45	A39	B39
	TX -	Gray/Yellow	20	A40	B40
11	RX +	Violet/Blue	46	A41	B41
	RX -	Blue/Violet	21	A42	B42
	TX +	Violet/Orange	47	A43	B43
	TX -	Orange/Violet	22	A44	B44
12	RX +	Violet/Green	48	A45	B45
	RX -	Green/Violet	23	A46	B46
	TX +	Violet/Brown	49	A47	B47
	TX -	Brown/Violet	24	A48	B48
Unused Pair	N/A	-	25	N/A	N/A
	N/A	-	50	N/A	N/A

Crossovers

The 10BASE-T and 100BASE-TX specifications require that some UTP connections be crossed over. Crossing over is the reversal of the transmit and receive pairs at opposite ends of a single cable. Each cable that swaps the location of the transmit and receive pairs at only one end is called a crossover cable. Those cables that maintain the same pin numbers for transmit and receive pairs at both ends are called straight-through cables.

The 10BASE-T and 100BASE-TX specifications are designed around connections from networking hardware to end user stations being made through straight-through cabling. Because of this, the transmit wires of a networking device such as a standalone hub or repeater connect to the receive pins of a 10BASE-T or 100BASE-TX end station.

If two similarly-designed network devices are connected using a straight-through cable, the transmit pins of one device are connected to the transmit pins of the other device. In effect, the two devices will both attempt to transmit on the same pair of the cable between them.

To overcome this, a crossover must be placed between two like devices on a network, forcing the transmit pins of one device to connect to the receive pins of the other device. When two like devices are being connected to one another using UTP cabling, an odd number of crossover cables, preferably one, must be part of the cabling between them.

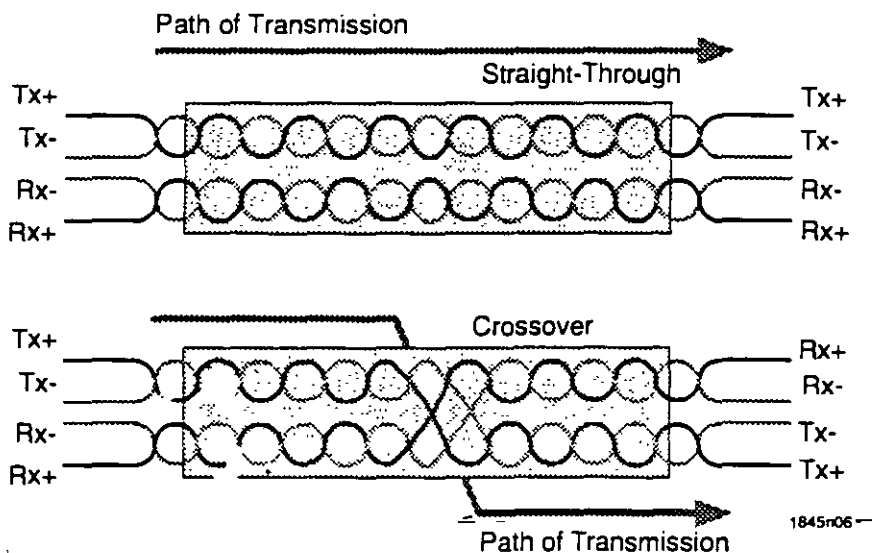

Figure 4-6. Straight-Through vs. Crossover Cables

UTP Cable Quality

UTP cabling is produced in a number of overall quality levels, called Categories. The requirements of networking limit UTP cabling for Ethernet to Categories 3, 4, and 5. Any of these cable Categories can be used in an Ethernet installation, provided that the requisite IEEE 802.3 specifications regarding the cables are met.

Category 3

UTP cabling that is built to the Category 3 specification consists of two or more pairs of solid 24 AWG copper strands. Each strand, approximately 0.02 inch thick, is surrounded by a layer of insulation. The characteristics of the insulation are determined by the fire resistant construction of the cable (plenum cable is thicker and made with slightly different material than normal PVC cabling).

The individual wires are twisted into pairs. The twisted pairs of cable are laid together within an outer jacket, that may be low-smoke PVC plastic or a plenum-rated insulating material. The outer jacket surrounds, but does not adhere to, the wire pairs that make up the cable.

Category 3 UTP cabling must not produce an attenuation of a 10 MHz signal greater than 98 dB/km at the control temperature of 20° C.

Category 4

Category 4 UTP cabling is constructed in the same manner as the Category 3 cabling discussed previously. Category 4 UTP is constructed using copper center strands of 24 or 22 AWG. The resulting wire pairs are then covered by a second layer of insulating jacketing. Higher-quality materials and a closer association of the twisted pairs of wire improve the transmission characteristics of the cable in comparison to Category 3 cabling.

Category 4 UTP cabling must not produce an attenuation of a 10 MHz signal greater than 72 dB/km at the control temperature of 20° C.

Category 5

Category 5 UTP cabling is manufactured in the same fashion as Category 3 cable, but the materials used are of higher quality and the wires that make up the pairs are more tightly wound than those in lower Category classes. This closer association helps to reduce the likelihood that any one member of a pair may be affected by external noise sources without the other member of the pair experiencing the same event. Only Category 5 cable may be used in 100BASE-TX networks.

Category 5 UTP consists of 2 or more pairs of 22 or 24 AWG wire. Category 5 cable is constructed and insulated such that the maximum attenuation of a 10 MHz signal in a cable run at the control temperature of 20° C is 65 dB/km. A cable that has a maximum attenuation higher than 65 dB/km does not meet the Category 5 requirements.

Fiber Optics

Fiber optic cable is a high performance media constructed of glass or plastic that uses pulses of light as a transmission method. Because fiber optics do not utilize electrical charges to pass data, they are free of interference due to proximity to electrical fields. This, combined with the extremely low rate of signal degradation and dB loss makes fiber optics able to traverse extremely long distances. The actual maximums are dependent upon the architecture being used, but distances upwards of 2 kilometers (1.2 miles) are not uncommon.

Glass optical fiber is made up of a glass strand, the core, that allows for the easy transmission of light, the cladding, a less transmissive glass layer around the core that helps keep the light within the core, and a plastic buffer that protects the cable.

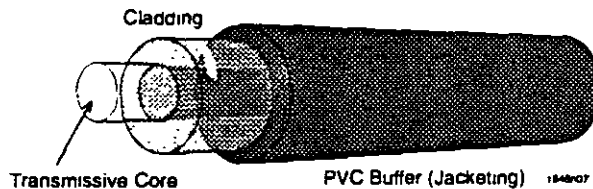

Figure 4-7. Fiber Optic Cable Construction (multimode)

There are two basic types of fiber optics, multimode and single mode. The names come from the types of light used in the transmission process. Multimode fiber uses inexpensive Light Emitting Diodes (LEDs) that produce light of a single color. Due to the nature of the LED, the light produced is made up of a number of differing wavelengths of light, fired outward from the center of the LED. Not all the rays of light enter the fiber, and those that do often do so at an angle, which reduces the amount of distance the signal can effectively cover. Single mode fiber optics use lasers to achieve greater maximum distances. Since light from a laser is all of the same wavelength, and travels in a coherent ray, the resulting signal tends to be much clearer at reception than an LED signal under the same circumstances.

Fiber optics of both types are measured and identified by a variety of means. The usual means of referring to a fiber optic cable type is to identify if it is single mode or multimode, and to describe the thickness of each strand. Fiber optics are very thin, and the diameter of each strand is measured in microns (μm). Two measurements are important in fiber optic identification; the diameter of the core, where signals travel, and the diameter of the cladding, which surrounds the core. Thus, fiber optic measurements will usually provide two numbers separated by the "/" symbol. The first number is the diameter, in microns, of the core. The second is the diameter of the cladding. Thus, a 62.5/125 multimode cable is a type of fiber optic cabling with a 62.5 micron core and 125 micron cladding, which is commonly used by LED driven transmitting devices.

In much the same way that UTP cabling is available in two-, four-, 25-, and 50-pair cables, strands of fiber optic cabling are often bound together with other strands into multiple strand cables. These multiple strand cables are available with anywhere from two to 24 or more strands of fiber optics, all gathered together into one protective jacket.



Cabletron Systems recommends that customers planning to install fiber optic cabling not install any facility fiber optics (non-jumper cabling) containing fewer than six strands of usable optical fiber. The minimum number of strands needed to make an end-to-end fiber optic link between two network devices is **two** (using the Ethernet network architecture). In the event that a strand within the cable is damaged during installation or additional fiber pairs become desired along the cable path, the availability of extra strands of optical fiber will reduce the likelihood that a new cable must be pulled. The existing, unused pairs of optical fiber can be terminated and used immediately.

Multimode

Multimode fiber optic cabling is designed and formulated to allow the propagation of many different wavelengths, or modes, of light. Multimode fiber optics are the most commonly encountered fiber type in Ethernet installations, due to their lower cost compared to other fiber types.

Multimode fiber optics may be terminated with any type of fiber optic connector; SMA, ST, FDDI MIC, or the new and not currently standardized SC connector.

Single Mode

Single mode fiber optics are designed specifically to allow the transmission of a very narrow range of wavelengths within the core of the fiber. As the precise wavelength control required to accomplish this is performed using lasers, which direct a single, narrow ray of light, the transmissive core of single mode fiber optics is typically very small (8 to 10 μm). Single mode fiber is more expensive to produce than multimode fiber, and is typically used in long-haul applications.

Due to the very demanding tolerances involved in connecting two transmissive media with diameters approximately one-quarter as thick as a sheet of paper, single mode fiber optics require very precise connectors that will not move or shift over time. For this reason, single mode fiber optics should only be terminated with locking, preferably keyed, connectors. Fiber optic connector types such as the ST, SC, or FDDI MIC connector all meet the requirements of single mode fiber optics, if installed and tested properly.



Fast Ethernet Network Requirements

This chapter provides test parameters and specification requirements for Fast Ethernet network cabling.

100BASE-TX

All Cabletron Systems 100BASE-TX products require that installed facility cabling and cable hardware meet the following minimum specifications. If a network cabling installation is not within the limitations presented here, the operation of the 100BASE-TX products may be affected.

Cable Type

The operation of a 100BASE-TX network is more demanding than that of standard Ethernet, and high-quality cables are required. The 100BASE-TX specification for Fast Ethernet networks requires UTP cabling Category 5. Categories of UTP cabling below Category 5 may not meet the quality requirements of the networking specification, and may therefore be unable to meet the tested characteristics listed below.

The Category of cabling used in a network installation is dependent upon all the components that make up the cabling run. If an installation utilizes Category 5 cabling, and the wallplates and patch panels to which that cabling is connected are Category 3 compliant, the cable does not meet the EIA/TIA end-to-end specifications for a Category 5 installation.



Due to the construction of the connectors and organization of wires, the 25-pair RJ21 connector is not Category 5 compliant.

The TIA/EIA 568A cabling specification for Category 5 compliant UTP installations allows the use of two different types of cable: horizontal wire and patch wire. The specification allows horizontal wire to be used to cover distances of up to 90 m, while patch wire is restricted to a maximum length of 10 m.



A third type of TIA/EIA 568 A cabling, **backbone wire**, does not apply to this implementation of the 100BASE-TX standard, and is not discussed in this chapter.

Horizontal wire must be constructed with solid core wires. Horizontal wire is intended to be used as the "in-the-wall" cabling of the network. Patch wire is constructed with more flexible stranded core wires, and is useful in situations where bending or movement of the wire is expected. Patch wire should only be used for connections between punchdown blocks, patch panels, or workstations.

Insertion Loss (Attenuation)

The maximum allowable insertion loss for any 100BASE-TX station on the Fast Ethernet network is 24.0 dB at a frequency of 100 MHz. This calculation must take all cabling devices in the cable path into account. A typical insertion loss test must include the jumper cabling used at the station and at the wiring closet, and any patch panels, punchdown blocks, and wallplates in the installation.

Impedance

Cabletron Systems 100BASE-TX equipment requires that 100BASE-TX cables in the Fast Ethernet network have an impedance within the range of 75 to 165 Ω . Typical UTP cables used in Fast Ethernet environments have an impedance between 85 and 111 Ω .

Jitter

Jitter may be caused by intersymbol interference and reflection of signal. Networking technologies that rely on particular timing or clocking schemes may be affected by jitter due to excessive signal reflection. Any 100BASE-TX cable installation should not exceed 1.4 ns of jitter. If a cable run meets the 100BASE-TX impedance requirements (detailed above), jitter should not be a concern.

Delay

The maximum propagation delay allowable on a 100BASE-TX segment is 1 microsecond (μs). If a Fast Ethernet signal is unable to traverse the entire length of an installed UTP cable run within 1 μs , Out of Window (OOW) errors will occur due to excessive delays between transmission of signals and notification of collisions. This propagation delay requirement limits UTP cabling to a total maximum length of 100 m (328 ft).

Crosstalk

Fast Ethernet UTP cables should be checked for Near-End Crosstalk, or NEXT, at installation. The acceptable amount of NEXT between pairs in a four-pair cable is not less than 27 dB for a 100 MHz link.

Noise

As "noise" is not a readily quantified and tested aspect of installed cables, there are no hard and fast rules for the amount of acceptable cable noise on a 100BASE-TX segment. If a cable that meets all other requirements for 100BASE-TX operation is experiencing an unusual number of errors, the introduction of noise may be a problem.

If you suspect that noise is causing signal degradation, examine the cable or cables in question. If they are near possible sources of outside noise, such as lighting fixtures, electric motors, or transformers, reroute the cable.

Other Considerations

Due to the small gauge of the wires in a UTP cable, it is susceptible to changes in attenuation due to heat. In an installation that exceeds the control temperature of 20° C (68° F), the attenuation of PVC jacketed UTP cabling that is within the 11 dB limitations may fall outside the acceptable range of attenuation. In installations where UTP cables are expected to be subjected to temperatures of 40° C (104° F) or greater, the use of plenum-jacketed cabling is recommended. The thicker insulating jacket of a plenum-rated cable reduces the susceptibility of that cable to heat-induced changes in attenuation characteristics.

The IEEE 802.3 100BASE-TX specification requires that all 100BASE-TX devices support UTP cables up to 100 m (328 ft) in length. This requirement does not factor in losses due to connectors, patch panels, punchdown blocks, or other cable management hardware, which introduce additional loss.

For each connector or other intrusive cable management device in the total link, subtract 12 m (39.4 ft) from the total allowable link length for purposes of estimation.

100BASE-FX (Multimode)

All Cabletron Systems 100BASE-FX products require that installed facility cabling and cable hardware meet the following minimum specifications. If a network cabling installation is not within the limitations presented here, the operation of the 100BASE-FX products may be affected.

Cable Type

Networking devices built to the 100BASE-FX specification require specific types of cabling. 100BASE-FX multimode fiber optic devices manufactured by Cabletron Systems are able to support connections to and from 62.5/125 μm multimode fiber optics.

Attenuation

Multimode fiber optic cables must be tested for attenuation with a fiber optic attenuation test set. The test set must be configured to determine attenuation of the cable at a wavelength of 850 nm. The attenuation test will confirm or deny that the cable falls within an acceptable level. The acceptable level of attenuation for a 100BASE-FX cable is 11.0 dB.

Insertion Loss

The 100BASE-FX specification allows for a total dB loss of 10.0 dB or less between any two stations or devices connected by fiber optic cabling. When calculating insertion loss, you must consider and count any loss introduced by fiber optic splices, barrel connectors, distribution boxes or other cable management devices. The typical dB loss for a splice or a connector is less than 1 dB. The loss statistics for any fiber optic cable management hardware should be available from the manufacturer.

Delay

As fiber optic cabling is often used to make connections between Fast Ethernet repeaters or hubs, the 100BASE-FX specification allows a multimode fiber optic link to be configured such that the total propagation delay for the link is less than or equal to 2.56 μ s one-way. Keep in mind, however, that propagation delay must be calculated for the entire network. If there are more stations than the one connected by your fiber optic link, you must also calculate the propagation delay for the longest of those station links.

If the total one-way propagation delay of any signal path exceeds 2.56 μ s, the Fast Ethernet network is out of specifications, and error conditions may result. To eliminate propagation delay problems, incorporate some form of segmentation, such as bridging or routing, into the network to separate the problem signal paths from one another.

Length

The 100BASE-FX specification limits a multimode fiber optic cable segment to 412 m or less. Assuming that a fiber optic cable meets all other limitations for 100BASE-FX usage, it is possible to extend a multimode fiber optic link to an estimated maximum of 2 km. At a length of more than 2 km, the propagation delay introduced by the multimode fiber optic cable segment may exceed the 2.56 μ s limit of the Fast Ethernet specification and cause excessive OOW errors. Cabletron Systems does not recommend the installation or use of any multimode fiber optic cable segment that exceeds 100BASE-FX limitations of 412 m.

Hybrid Installations

In Fast Ethernet networks, the combining of fiber optic and unshielded twisted pair media in a single, repeated network requires calculating a network radius. This is because the delay requirements for a Fast Ethernet network are so demanding that a mixed-media network must take the differences between the standard media into account.

The network radius is the calculation of the longest path in the Fast Ethernet repeater domain (from one station to a Fast Ethernet repeater and out to another station). Figure 7-1 shows an example of a mixed media Fast Ethernet repeater domain.

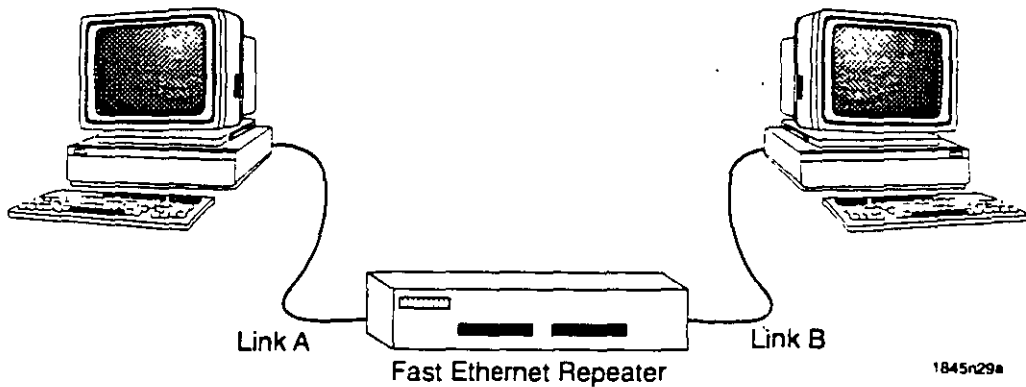

Figure 7-1. Fast Ethernet Network Radius

If the two longest links in the Fast Ethernet repeater domain are both made using UTP cable, each UTP segment may be 100 m in length, for a total network radius of 200 m. If these links were both made using multimode fiber optics, the allowable maximum network radius would be 272 m, less than that allowed by a repeater with a single 100BASE-FX link.

When media are mixed in a Fast Ethernet network, the allowable network radius changes slightly. In a mixed UTP and multimode fiber optic network, the maximum radius is 263 m. This means that the longest UTP segment in the Fast Ethernet network may be up to 100 m, and the longest 100BASE-FX link may be 160 m. The maximum network radius for each Fast Ethernet media configuration is provided in Table 7-1.

Repeater Classes

Repeaters in Fast Ethernet networking are divided into two categories, or "classes" by the 100BASE-TX standard. The difference between these Class I and Class II repeaters is the method each uses to handle received signals for transmission. The different techniques result in different rules of configuration for a Fast Ethernet network.

Class I repeaters receive the 100BASE-TX electrical signal on one interface and translate that signal from its electrical form into a digital series, much in the same way that a Fast Ethernet station receives a transmission. The Class I repeater then generates a new signal on each of its interfaces using the translated digital series. The Class I repeater does not make any decisions based on the received signal, nor does it perform any error-checking. The translation of the received signal is intended to improve the strength and validity of the repeated Fast Ethernet frame.

The Class II repeater receives and immediately repeats each received transmission without performing any translation. The repeating process is a simple electrical duplication and strengthening of the signal.

The design and operation of these different repeater types result in different operating characteristics and network limitations. Class I repeaters, by translating the received signal, produce a stronger repeated transmission. The translation process, however, takes up a number of microseconds. This additional delay reduces the total distance a signal may travel before the allowable delay for that transmission has elapsed. While Class II repeaters are faster, the signals they produce are less precise, and they cannot connect to different media types.

These differences mean that, in any Fast Ethernet network, there may be a maximum of one Class I or two Class II repeaters between any two end stations. These implementations also result in different maximum network radii, as shown in Table 7-1.

Buffered Uplinks

Several Fast Ethernet devices support the incorporation of buffered uplinks to help alleviate the pressures placed on network design by the small network radius of Fast Ethernet networks. The buffered uplink acts as a non-filtering bridge, providing little more than retiming and regeneration of signals. In effect, the buffered uplink provides only the distance characteristics of a bridged connection. Fast Ethernet networks that incorporate a buffered uplink effectively extend the maximum network radius. The multimode fiber optic buffered uplink can be up to 400 m in length. The overall allowable network radius for Fast Ethernet networks that incorporate buffered uplinks are also provided in Table 7-1.

Table 7-1. Fast Ethernet Maximum Network Radii

Repeater Class	UTP	UTP & Fiber Optics	Fiber Optics	UTP & Buffered Uplink	Fiber Optics and Buffered Uplink
Class I	200 m	260 m	272 m	500 m	800 m
Class II	200 m	N/A	320 m	N/A	N/A



Full-Duplex Fast Ethernet Network Requirements

This chapter provides test parameters and specification requirements for Full-Duplex Fast Ethernet network cabling.

100BASE-TX

All Cabletron Systems 100BASE-TX products require that installed facility cabling and cable hardware meet the following minimum specifications. If a network cabling installation is not within the limitations presented here, the operation of the 100BASE-TX products may be affected.

It is important to remember that full-duplex Fast Ethernet operation requires dedicated single links from one port of a Fast Ethernet switch to another Fast Ethernet switch or a Fast Ethernet workstation. If both endstations are not capable of full-duplex operation, a standard Fast Ethernet link will be automatically established.

Cable Type

100BASE-TX network operations are more demanding than those of standard Ethernet, and high-quality cables are required. The 100BASE-TX specification for Fast Ethernet networks requires UTP cabling meeting Category 5 specifications. Categories of UTP cabling below Category 5 may not meet the quality requirements of the networking specification, and may therefore be unable to meet the tested characteristics listed below.

The Category of cabling used in a network installation is dependent upon all the components that make up the cabling run. If an installation utilizes Category 5 cabling, and the wallplates and patch panels to which that cabling is connected are Category 3 compliant, the cable does not meet the EIA/TIA end-to-end specifications for a Category 5 installation.

Insertion Loss (Attenuation)

The maximum allowable insertion loss for any 100BASE-TX station on the Fast Ethernet network is 11.5 dB at frequencies from 5 to 10 MHz. This calculation must take all cabling devices in the cable path into account. A typical insertion loss test must include the jumper cabling used at the station and at the wiring closet, and any patch panels, punchdown blocks, and wallplates in the installation.

The insertion loss characteristics of a cable are one of the main determinants of link length allowed by the Fast Ethernet and 100BASE-TX specifications. As long as a UTP cable does not exceed the total link length of 11.5 dB, it may be any length up to 100 m (328 ft). The 100 meter maximum total length is based on the total allowable propagation delay in the network, and cannot be exceeded.

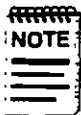

As longer cables are more susceptible to other limiting factors, Cabletron Systems does not recommend the installation of 100BASE-TX cabling over 100 m in length.

Impedance

Cabletron Systems 100BASE-TX equipment requires that 100BASE-TX cables in the Fast Ethernet network have an impedance within the range of 75 to 165 Ω . Typical UTP cables used in Fast Ethernet environments have an impedance between 85 and 111 Ω .

Jitter

Jitter may be caused by intersymbol interference and reflection of signal. Networking technologies that rely on particular timing or clocking schemes may be affected by jitter due to excessive signal reflection. Any 100BASE-TX cable installation should not exceed 1.4 ns of jitter. If a cable run meets the 100BASE-TX impedance requirements (detailed above), jitter should not be a concern.

Crosstalk

Crosstalk is electrical interference between wires. Crosstalk occurs when a cable strand absorbs signals from other wires that it is adjacent to. Excessive crosstalk can be caused by a break in the insulation or shielding that separates wires from one another in a bundle.

Fast Ethernet UTP cables should be checked for Near-End Crosstalk, or NEXT, at installation. The allowable amount of NEXT for a UTP cable is dependent upon the type of cable used in the installation.

25-Pair Cable

The acceptable amount of NEXT between pairs in a 25-pair cable is at least 60 dB for a 10 MHz link.



Due to the construction of the connectors and organization of wires, the 25-pair RJ21 connector is not Category 5 compliant.

Four-Pair Cable

The acceptable amount of NEXT between pairs in a four-pair cable is not less than 60 dB for a 10 MHz link.

Noise

As "noise" is not a readily quantified and tested aspect of installed cables, there are no hard and fast rules for the amount of acceptable cable noise on a 100BASE-TX segment. If a cable that meets all other requirements for 100BASE-TX operation is experiencing an unusual number of errors, the introduction of noise may be a problem.

If you suspect that noise is causing signal degradation, examine the cable or cables in question. If they are near possible sources of outside noise, such as lighting fixtures, electric motors, or transformers, reroute the cable.

Other Considerations

Due to the small gauge of the wires in UTP cabling, it is susceptible to changes in attenuation due to heat. In an installation that exceeds the control temperature of 20° C (68° F), the attenuation of PVC jacketed UTP cabling that is within the 11.5 dB limitations may fall outside the acceptable range. In installations where UTP cables are expected to be subjected to temperatures of 40° C (104° F) or greater, the use of plenum-jacketed cabling is recommended. The thicker insulating jacket of a plenum-rated cable reduces the susceptibility of that cable to heat-induced changes in attenuation characteristics.

The IEEE 802.3 100BASE-TX specification requires that all 100BASE-TX devices support UTP cables of not less than 100 m (328 ft) in length. This requirement does not factor in losses due to connectors, patch panels, punchdown blocks, or other cable management hardware, which introduce additional loss.

For each connector or other intrusive cable management device in the total link, subtract 12 m (39.4 ft) from the total allowable link length.

Length

The 100BASE-TX standard specifies that any 100BASE-TX compliant device must be capable of transmitting a Fast Ethernet signal not less than 100 m (328 ft) over a UTP cable segment that meets the quality values listed above. As long as all specifications are met for the entire length of the cable, UTP cable segments can be run up to a maximum allowable length of 260 m (852 ft).



As longer cables are more susceptible to noise and other limiting factors, Cabletron Systems does not recommend the installation of 100BASE-TX cabling over 100 m in length.

FDDI Media

This chapter details the standard media and connector types that may be used in Fiber Distributed Data Interface (FDDI) networks.

Cabling Types

Unshielded Twisted Pair (UTP)

Unshielded Twisted Pair cabling (referred to here as UTP, but also may be termed copper wire, 10BASE-T wire, Category 5 wire, telephone cable, or twisted pair without shielded or unshielded qualifier) is commonly made up of four pairs of 22, 24, or 26 AWG unshielded copper solid or stranded wires. These pairs of wires are twisted together throughout the length of the cable. These twisted pairs of wire within the UTP cable are broken up into transmit and receive pairs. In each pair, one wire carries the normal FDDI transmission, while its associated wire carries a copy of the transmission that has been inverted.

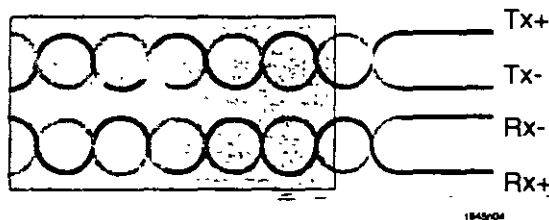

Figure 11-1. UTP Cable Pair Association (2 Pairs Shown)

The twisting of associated pairs helps to reduce the interference of the other strands of wire throughout the cable. This is due to the method of transmission used with twisted pair transmissions.

In any transceiver or Network Interface Card (NIC), the network protocol signals to be transmitted are in the form of changes of electrical state. The means by which the ones and zeroes of network communications are turned into these signals is called encoding. In a twisted pair environment, once a transceiver has been given an encoded signal to transmit, it will copy the signal and invert the polarity of that signal (see Figure 11-2, below). The result of this inverted signal is a mirror opposite of the original signal.

Both the original and the inverted signal are then transmitted, the original signal over the one transmit wire, the inverted signal over the other. As these wires are the same length, the signal travels at the same rate (propagates) through the cable. Since the pairs are twisted together, any outside electrical interference that affects one member of the pair will have the same effect on the other member of that pair.

The transmission travels through the cable, eventually reaching a destination transceiver. At this location, both signals are read in. The original signal is unchanged, but the signal that had previously been inverted is reverted to the original state. When this is done, it returns the encoded transmission to its original state, but reverses the polarity of any signal interference that the encoded transmission may have suffered.

Once the inverted transmission has been returned to the normal encoded state, the transceiver adds the two signals together. As the encoded transmissions are now identical, there is no change to the data content. Line noise spikes, however, are combined with noise spikes of their exact opposite polarity, causing them to cancel one another out.

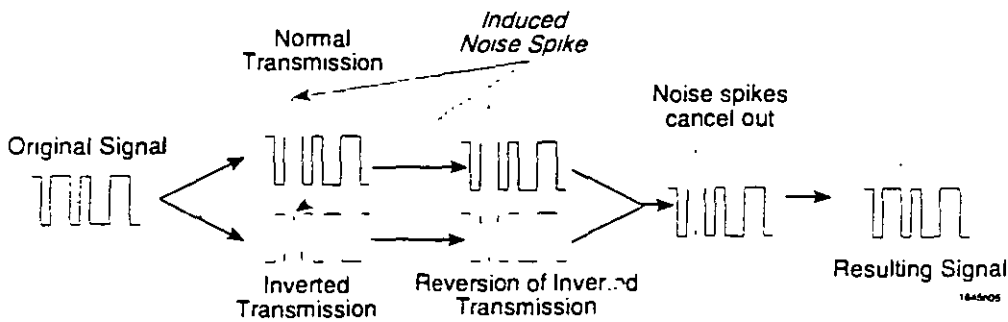

Figure 11-2. UTP Signal Equalization

The UTP cable used in network installations is the same type of cable used in the installation of telephone lines within buildings. UTP cabling is differentiated by the quality category of the cable itself, which is an indicator of the type and quality of wire used and the number of times the wires are twisted around each other per foot. The categories range from Category 1 to Category 5, with Category 5 cabling being of the highest quality.

The wires that make up a length of UTP cable are numbered and color coded. These color codes allow the installer of the networking cable to determine which wires are connected to the pins of the RJ45 ports or patch panels. The numbering of the wires in EIA/TIA standard cables is based on the color of the insulating jacket that surrounds the core of each wire.

The association of pairs of wire within the UTP cable jacket are decided by the specifications to which the cable is built. There are two main EIA/TIA specifications in use around the world for the production of UTP cabling; EIA/TIA 568A and the EIA/TIA 568B. The two wiring standards are different from one another in the way that the wires are associated with one another at the connectors.

Since the FDDI Twisted Pair - Physical Medium Dependent (TP-PMD) specification requires the use of all eight wires in a four-pair cable, the EIA/TIA specification to which the cable is constructed is of prime importance. The arrangement of the wires and pairs in the EIA/TIA 568 specifications is discussed in the UTP portion of the **Connector Types** section of this chapter.

Keep in mind that the selection of an EIA/TIA wiring scheme will determine the characteristics of Wallplates, Patch Panels, and other UTP interconnect hardware you add to the network. Most manufacturers supply hardware built to both of these specifications.



TP-PMD Specifications limit the use of UTP cabling to Single Attached Station connections from FDDI concentrators to stations (M ports to S ports).

Crossovers

As all connectors in the FDDI TP-PMD specification are organized in the same fashion with regard to pinouts, the FDDI TP-PMD specification requires JTP connections between TP-PMD devices be crossed over. Crossing over is the reversal of the transmit and receive pairs at opposite ends of a single cable. Each cable that swaps the location of the transmit and receive pairs at only one end is called a crossover cable. Those cables that maintain the same location for transmit and receive pairs at both ends are called straight-through cables.

If two TP-PMD devices are connected using a straight-through cable, the transmit pins of one device will be connected to the transmit pins of the other device. In effect, the two devices will both attempt to transmit on the same pair of the cable between them. This will cause the FDDI ring to wrap.

To overcome this, a crossover must be placed between the FDDI TP-PMD ports, forcing the transmit pins of one device to connect to the receive pins of the other device. When two devices are being connected to one another using UTP cabling, an odd number of crossover cables, preferably one, must be part of the cabling between them. For ease of cable management, it is preferable to use straight-through cabling for horizontal cable runs, and place any necessary crossover cables in the wiring closet or data center.

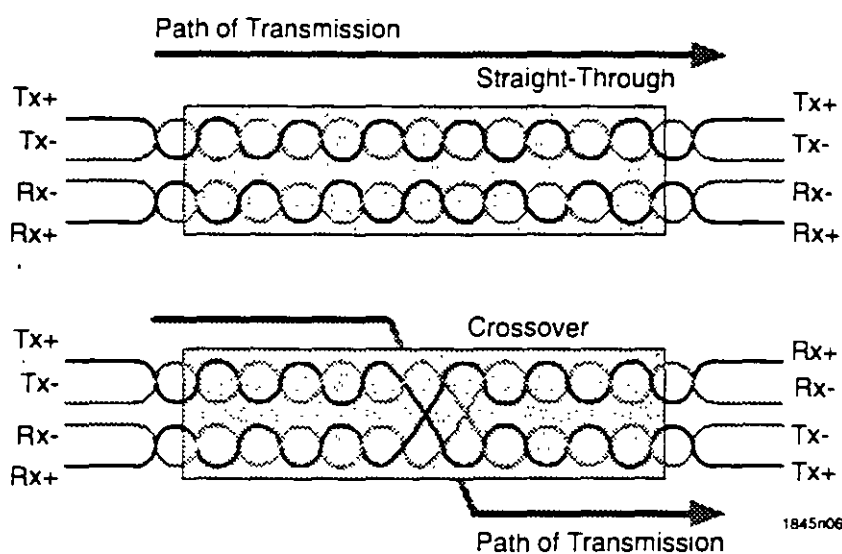

Figure 11-3. Straight-Through vs. Crossover Cables

UTP Cable Quality

UTP cabling is produced in a number of overall quality levels, called Categories. The UTP cabling used in FDDI installations must adhere to the minimum quality characteristics detailed in the ANSI X3T9.5 TP-PMD specification. UTP cabling that is Category 4 or lower is not capable of meeting the stringent quality requirements of the TP-PMD specification, and should never be used in an FDDI environment. Only cabling of Category 5 may be used for FDDI TP-PMD installations. Descriptions of lower-quality cables may be found in the Ethernet and Token Ring sections of this document.

Category 5

Category 5 UTP cabling is manufactured in the same fashion as standard telephone installation cable, but the materials used are of higher quality and the wires that make up the pairs are more tightly wound. This closer association helps to reduce the likelihood that any one member of a pair may be affected by external noise sources without the other member of the pair experiencing the same event.

Category 5 UTP consists of 2 or more pairs of 22 or 24 AWG wire. Category 5 cable is constructed and insulated such that the maximum attenuation of a 10 MHz signal in a cable run at the control temperature of 20° C is 65 dB/km. A cable that has a higher maximum attenuation than 65 dB/km does not meet the Category 5 requirements.

Shielded Twisted Pair (STP)

The TP-PMD specification is also able to utilize high-quality Shielded Twisted Pair, or STP cable. Shielded Twisted Pair cabling is a multistranded cable most often constructed of four 26 AWG conductive copper solid or stranded core wires. Each wire is surrounded by a non-conductive insulating material such as Polyvinyl Chloride (PVC). These wires are twisted around one another in a specific arrangement to form pairs. The pairs are made up of associated wires - transmit wires are paired with transmit wires, receive wires are paired with receive wires.

Each pair in the STP cable is then surrounded by a metallic foil shield that runs the length of the cable. Some types of STP incorporate an additional braided or foil shield that surrounds each of the shielded pairs in the cable. The overall cable is wrapped in an insulating jacket that covers the shields and holds the wires together.

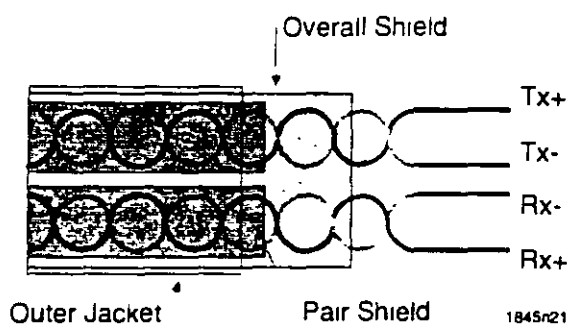

Figure 11-4. STP Cable Pair Association

Twisting the pairs together throughout the cable helps to reduce the effects of externally-induced electrical noise on the signals that pass through the cable. In each pair, one wire carries the normal network signal, while its associated wire carries a copy of the transmission that has been inverted.

The twisting of associated pairs helps to reduce the interference of the other strands of wire throughout the cable. This is due to the method of transmission used with twisted pair transmissions.

In any transceiver or Network Interface Card (NIC), the network protocol signals to be transmitted are in the form of changes of electrical state. The means by which the ones and zeroes of network communications are turned into these signals is called encoding. In a twisted pair environment, once a transceiver has been given an encoded signal to transmit, it copies the signal and inverts the voltage (see Figure 11-5, below). The result of this inverted signal is a mirror opposite of the original signal.

Both the original and the inverted signal are then transmitted, the original signal over the one transmit wire, the inverted signal over the other. As these wires are the same length, the signal travels at the same rate (propagates) through the cable. Since the pairs are twisted together, any outside electrical interference that affects one member of the pair will have the same effect on the other member of that pair.

The transmission travels through the cable, eventually reaching a destination transceiver. At this location, both signals are read in. The original signal is unchanged, but the signal that had previously been inverted is reverted to the original state. When this is done, it returns the encoded transmission to its original state, but reverses the polarity of any signal interference that the encoded transmission may have suffered.

Once the inverted transmission has been returned to the normal encoded state, the transceiver adds the two signals together. As the encoded transmissions are now identical, there is no change to the data content. Line noise spikes, however, are combined with noise spikes of their exact opposite polarity, causing them to cancel one another out.

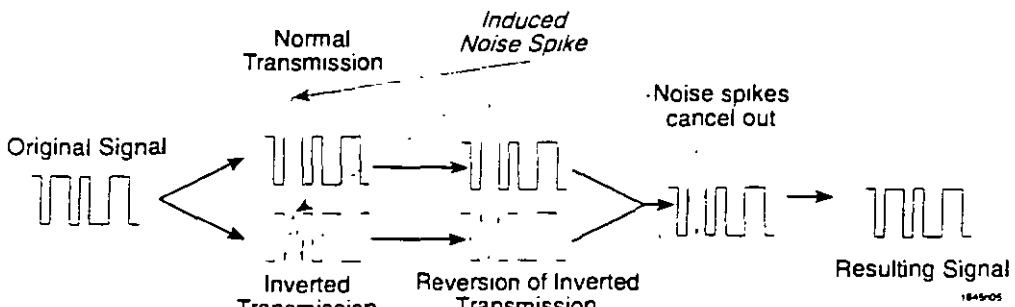
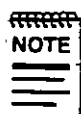

Figure 11-5. Twisted Pair Signal Equalization

STP cable is made up of four or more wires, and each wire within the cable has a specific insulator color. These colors are part of the industry specifications to which the cable construction process must be held. Each color identifies a particular usage for the cable. The four colors are black, red, green, and orange. Table 11-1, below, identifies the type of signal that each wire carries.

Table 11-1. STP Cable Wire Identifications

Cable Color	Application
Black	TX -
Red	RX +
Green	RX -
Orange	TX +



As STP cabling provides only two pairs of wire, it may only be used for Single Attached Station connections from FDDI concentrators to stations (M ports to S ports).

STP Cable Quality

STP cable is available in a series of construction and quality styles, known as Types. FDDI TP-PMD applications require STP cables that meet the quality and construction specifications of Type 1 or Type 2 STP cable, as detailed in the sections that follow.

Type 1

Type 1 STP consists of two pairs of solid 22 AWG copper strands. Each strand, approximately 0.02 inch thick, is surrounded by a layer of insulation. The characteristics of the insulation is determined by the fire resistance construction of the cable (plenum cable is thicker and made with slightly different material than normal PVC cabling).

The individual wires are twisted into pairs. The pairs that are formed by this twisting are then surrounded by a mylar foil shield. These shielded pairs are then laid alongside one another in an overall braided metal shield. The shield containing the twisted pairs is then surrounded by a tight outer covering. Type 1 STP is heavy and rather inflexible, but provides excellent resistance to interference and noise due to its construction characteristics. Type 1 STP is most commonly used as a facility cabling, while more flexible cabling is used for jumper cables and patch panel connections.

Type 2

IBM Type 2 cable is constructed in much the same fashion as Type 1 cable. The two central shielded pairs and the overall braided shield that surround them are constructed of the same materials, and then two additional pairs of AWG 22 insulated solid copper wires are laid outside the braided shield before the whole cable is surrounded by the tight outer covering. These outer wires may be used to carry telephone traffic, as the shields surrounding the inner, network wires is intended to eliminate the interference that might otherwise occur between the inner and outer pairs.



Cabletron Systems does not recommend combining active voice and data wiring in the same cable. Degradation of network performance may result from any non-standard uses of cable.

The added pairs of wire in a Type 2 cable make it even less flexible than Type 1 cable. For this reason, it is typically used as facility cable.

Fiber Optics

Fiber optic cable is a high performance media constructed of glass or plastic which uses pulses of light as a transmission method. Because fiber optics do not utilize electrical charges to pass data, they are free from the possibility of interference due to proximity to electrical fields. This, combined with the extremely low rate of signal degradation and dB loss makes fiber optics able to traverse extremely long distances. The actual maximums are dependent upon the architecture being used, but distances of up to 50 km (164,000 ft) are not unknown when using the FDDI technology.

Glass optical fiber is made up of a glass strand, the core, which allows for the easy transmission of light, the cladding, a less transmissive glass layer around the core which helps keep the light within the core, and a plastic buffer which protects the cable.

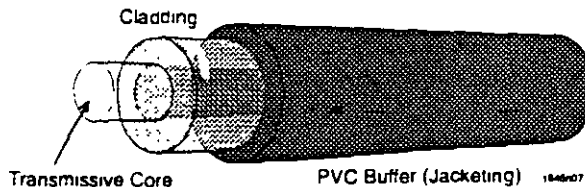

Figure 11-6. Fiber Optic Cable Construction

There are two basic types of fiber optics: multimode and single mode. The names come from the types of light used in the transmission process. Multimode fiber uses inexpensive Light Emitting Diodes (LEDs) that produce light of a single color. Due to the nature of the LED, the light produced is made up of a number of differing wavelengths of light, fired outward from the center of the LED. Not all the rays of light enter the fiber, and those that do often do so at an angle, which reduces the amount of distance the signal can effectively cover. Single mode fiber optics use lasers to achieve greater maximum distances. Since light from a laser is all of the same wavelength, and travels in a coherent ray, the resulting signal tends to be much clearer at reception than an LED signal under the same circumstances.

Fiber optics of both types are measured and identified by a variety of means. The usual means of referring to a fiber optic cable type is to identify if it is single mode or multimode, and to describe the thickness of each strand. Fiber optics are very thin, and the width of each strand is measured in microns (μm). Two measurements are important in fiber optic identification: the diameter of the core, where signals travel, and the diameter of the cladding, which surrounds the core. Thus, fiber optic measurements will usually provide two numbers separated by the "/" symbol. The first number is the diameter, in microns, of the core. The second is the diameter of the cladding. Thus, a 62.5/125 multimode cable is a type of fiber optic cabling with a 62.5 μm core and 125 μm cladding, which can be used by inexpensive LED equipment, as it allows multiple modes of light to pass through it. Incidentally, 62.5/125 μm multimode cabling is a very common type of FDDI fiber optics.

In much the same way that UTP cabling is available in two-, four-, 25-, and 50-pair cables, strands of fiber optic cabling are often bound together with other strands into multiple strand cables. These multiple strand cables are available with anywhere from two to 24 or more strands of fiber optics, all gathered together into one protective jacket.



Cabletron Systems recommends that customers planning to install fiber optic cabling not install any facility fiber optics (non-jumper cabling) containing fewer than six strands of usable optical fiber. The minimum number of strands needed to make an end-to-end fiber optic link between two FDDI network devices is **two**. In the event that a strand within the cable is damaged during installation or additional fiber pairs become desired along the cable path, the availability of extra strands of optical fiber will reduce the likelihood that a new cable must be pulled. The existing, unused pairs of optical fiber can be terminated and used immediately.

Multimode

Multimode fiber optic cabling is designed and formulated to allow the propagation of many different wavelengths, or modes, of light. Multimode fiber optics are the most commonly encountered fiber type in FDDI installations, due to their lower cost compared to other fiber types.

The FDDI MMF-PMD specification specifies the Media Interface Connector, or MIC, as the standard connector for MMF-PMD networks. The LCF-PMD specification recommends the use of the SC-Type connector for all station connections. Other connector types are nonstandard and their use may result in poor network performance. The MIC and SC connectors are described in greater detail in the **Connector Types** section of this chapter.

Single Mode

Single mode fiber optics are designed specifically to allow the transmission of a very narrow range of wavelengths within the core of the fiber. As the precise wavelength control required to accomplish this is performed using lasers, which direct a single, narrow ray of light, the transmissive core of single mode fiber optics is typically very small (8 to 10 μm). Single mode fiber is more expensive to produce than multimode fiber, and is typically used in long-haul applications. The FDDI networking technology allows for the creation of single mode fiber optic cabling runs of up to 58 km.

Due to the very demanding tolerances involved in connecting two transmissive media with diameters approximately one-quarter as thick as a sheet of paper, single mode fiber optics require very precise connectors that will not move or shift over time. For this reason, single mode fiber optics should only be terminated with locking, preferably keyed, connectors. The FDDI Single Mode Fiber Physical Medium Dependent (SMF-PMD) specification requires that all fiber optic cabling used in the FDDI network, regardless of type, should be connected only with MIC connectors, which are discussed in detail later in this chapter. Some FDDI devices for single mode fiber optics use the SC connector used by the LCF-PMD specification.

Low-Cost

In response to the expensive media and bulky connectors of the MMF-PMD and SMF-PMD standards, the Low Cost Fiber - Physical Medium Dependent, or LCF-PMD has been proposed. The LCF-PMD specification uses multimode fiber optics, and is terminated with smaller, less expensive connectors. The LCF-PMD specification allows for connections that are not longer than 500 m (1,640 ft). LCF-PMD links are designed for connections between concentrators and end stations.

The LCF-PMD specification uses the SC Connector, a modular, keyed connector designed much like the FDDI MIC connector (discussed in the **Connector Types** section of this document).

100BASE-FX (Multimode)

All Cabletron Systems 100BASE-FX products require that installed facility cabling and cable hardware meet the following minimum specifications. If a network cabling installation is not within the limitations presented here, the operation of the 100BASE-FX products may be affected.

Cable Type

Cabletron Systems 100BASE-FX network devices require specific types of cabling. 100BASE-FX multimode fiber optic devices manufactured by Cabletron Systems are able to support connections to and from the following types of multimode fiber optics:

- 50/125 μm
- 62.5/125 μm
- 100/140 μm

Attenuation

Multimode fiber optic cables must be tested for attenuation with a fiber optic attenuation test set. The test set must be configured to determine attenuation of the cable at a wavelength of 850 nm. The attenuation test will confirm or deny that the cable falls within an acceptable level. The acceptable level of attenuation for a 100BASE-FX cable is 11.0 dB.

Insertion Loss

The 100BASE-FX specification allows for a total dB loss of 10 dB or less between any two stations or devices connected by fiber optic cabling. When calculating insertion loss, you must consider and count any loss introduced by fiber optic splices, barrel connectors, distribution boxes or other cable management devices. The typical dB loss for a splice or a connector is less than 1 dB. The loss statistics for any fiber optic cable management hardware should be available from the manufacturer.

Delay

As fiber optic cabling is often used to make connections between Fast Ethernet repeaters or hubs, the 100BASE-FX specification allows a multimode fiber optic link to be configured such that the total propagation delay for the link is less than or equal to 2.56 μs one-way. Keep in mind, however, that propagation delay must be calculated for the entire network. If there are more stations than the one connected by your fiber optic link, you must also calculate the propagation delay for the longest of those station links.

If there is any signal path whose total one-way propagation delay exceeds 2.56 μ s, the Fast Ethernet network is out of specifications, and error conditions may result. To eliminate propagation delay problems, incorporate some form of segmentation, such as bridging or routing, into the network to separate the problem signal paths from one another.

Length

The 100BASE-FX specification limits a multimode fiber optic cable segment to 412 m or less. Assuming that a fiber optic cable meets all other limitations for 100BASE-FX usage, it is possible to extend a multimode fiber optic link to an estimated maximum of 2 km. At a length of more than 2 km, the propagation delay introduced by the multimode fiber optic cable segment may exceed the 2.56 μ s limit of the Fast Ethernet specification and cause excessive OOW errors. Cabletron Systems does not recommend the installation or use of any multimode fiber optic cable segment that exceeds 100BASE-FX limitations of 412 m.



Token Ring Media

This chapter examines the physical characteristics and requirements of both cabling and the connectors and ports used in Token Ring networks.

Cabling Types

Shielded Twisted Pair (STP)

Shielded Twisted Pair cabling is a multistranded cable most often constructed of eight 26 AWG conductive copper solid or stranded core wires. Each wire is surrounded by a non-conductive insulating material such as Polyvinyl Chloride (PVC). These wires are twisted around one another in a specific arrangement to form pairs. The pairs are made up of associated wires - transmit wires are paired with transmit wires, receive wires are paired with receive wires.

Each pair in the STP cable is then surrounded by a metallic foil shield that runs the length of the cable. Some types of STP incorporate an additional braided or foil shield that surrounds each of the shielded pairs in the cable. The overall cable is wrapped in an insulating jacket which covers the shields and holds the wires together.

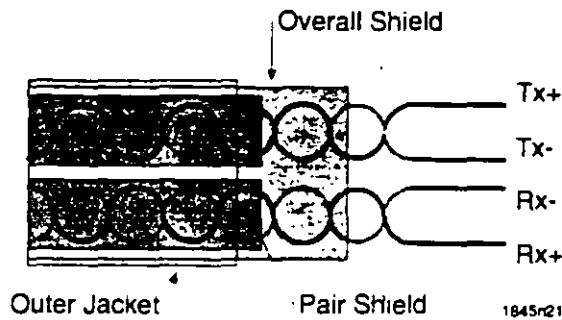

Figure 9-1. STP Cable Pair Association

Twisting the pairs together throughout the cable helps to reduce the effects of externally-induced electrical noise on the signals that pass through the cable. In each pair, one wire carries the normal network signal, while its associated wire carries a copy of the transmission that has been inverted.

The twisting of associated pairs helps to reduce the interference of the other strands of wire throughout the cable. This is due to the method of transmission used with twisted pair transmissions.

In any transceiver or Desktop Network Interface Card (DNI or NIC), the network protocol signals to be transmitted are in the form of changes of electrical state. The means by which the ones and zeroes of network communications are turned into these signals is called encoding. In a twisted pair environment, once a transceiver has been given an encoded signal to transmit, it copies the signal and inverts the voltage (see Figure 9-2). The result of this inverted signal is a mirror opposite of the original signal.

Both the original and the inverted signal are then transmitted, the original signal over the TX + transmit wire, the inverted signal over the TX - wire. As these wires are the same length, the signal travels at the same rate (propagates) through the cable. Since the pairs are twisted together, any outside electrical interference that affects one member of the pair will have the same effect on the other member of that pair.

The transmission travels through the cable, eventually reaching a destination transceiver. At this location, both signals are read in. The original signal is unchanged, but the signal that had previously been inverted is reverted to the original state. When this is done, it returns the encoded transmission to its original state, but reverses the polarity of any signal interference that the encoded transmission may have suffered.

Once the inverted transmission has been returned to the normal encoded state, the transceiver adds the two signals together. As the encoded transmissions are now identical, there is no change to the data content. Line noise spikes, however, are combined with noise spikes of their exact opposite polarity, causing them to cancel one another out.

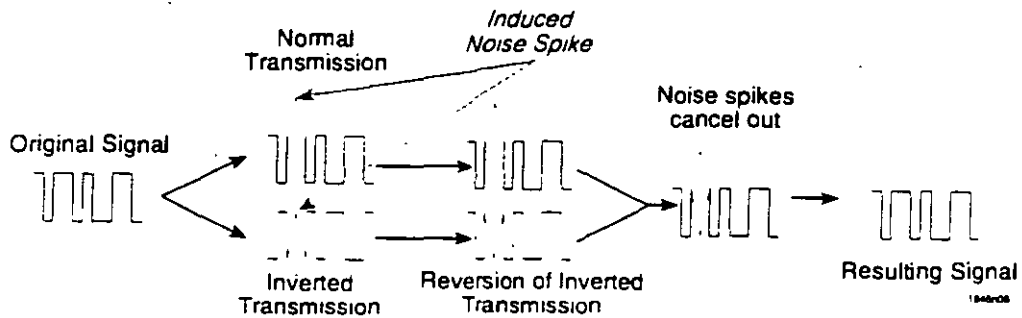

Figure 9-2. Twisted Pair Signal Equalization

STP cable is made up of four or more wires, and each wire within the cable has a specific insulator color. These colors are part of the IEEE specifications to which the cable construction process must be held. Each color identifies a particular usage for the cable. The four standard colors are black, red, green, and orange. Table 9-1, below, identifies the type of signal that each wire carries.

Table 9-1. STP Cable Wire Identifications

Cable Color	Application
Black	TX -
Red	RX +
Green	RX -
Orange	TX +

STP cabling is available in several different arrangements and construction styles, called Types. The type definitions are based on the IBM cabling system. STP cabling that may be used in Token Ring environments falls into four types, called Type 1, Type 2, Type 6, and Type 9. Any of these cable Categories can be used in a Token Ring installation, provided that the requisite IEEE 802.5 specifications regarding the cables are met.

Type 1

Type 1 STP consists of two pairs of solid 22 AWG copper strands. Each strand, approximately 0.02 inch thick, is surrounded by a layer of insulation. The characteristics of the insulation is determined by the fire resistance construction of the cable (plenum cable is thicker and made with slightly different material than normal PVC cabling).

The individual wires are twisted into pairs. The pairs that are formed by this twisting are then surrounded by a mylar foil shield. These shielded pairs are then laid alongside one another in an overall braided metal shield. The shield containing the twisted pairs is then surrounded by a tight outer covering. Type 1 STP is heavy and rather inflexible, but provides excellent resistance to interference and noise due to its construction characteristics. Type 1 STP is most commonly used as a facility cabling, while more flexible cabling is used for jumper cables and patch panel connections.

Type 2

IBM Type 2 cable is constructed in much the same fashion as Type 1 cable. The two central shielded pairs and the overall braided shield which surrounds them are constructed of the same materials, and then two additional pairs of AWG 22 insulated solid copper wires are laid outside the braided shield before the whole cable is surrounded by the tight outer covering. These outer wires may be used to carry telephone traffic, as the shields surrounding the inner, network wires is intended to eliminate the interference that might otherwise occur between the inner and outer pairs.



Cabletron Systems does not recommend combining active voice and data wiring in the same cable. Degradation of network performance may result from any non-standard uses of cable.

The added pairs of wire in a Type 2 cable make it even less flexible than Type 1 cable. For this reason, it is typically used as facility cable. Lighter-gauge, more flexible cable types, such as Types 6 and 9, discussed below, are frequently used as patch cables between networking hardware and Type 2 cable.

Type 6

Type 6 cable uses the same dual-shielded construction that Type 1 and Type 2 cable use, but the materials used in the construction are of a narrower gauge. The wires that make up the twisted pairs in a Type 6 cable are constructed of 26 AWG stranded conductors.

The construction materials used in Type 6 cabling make it a much more flexible form of STP, but greatly reduce the cable's ability to carry network signals over long distances. Type 6 cable is intended for use as jumper or patch panel cabling only.

Type 9

Type 9 cable is similar in construction to Type 6 cable, and is intended to be used for the same purposes. The center strands of a Type 9 cable are made of either solid or stranded 26 AWG conductors.

Unshielded Twisted Pair (UTP)

Unshielded Twisted Pair cabling (referred to here as UTP) is commonly made up of two or four pairs of 22, 24, or 26 AWG unshielded copper solid or stranded wires. These pairs of wires are twisted together throughout the length of the cable. These twisted pairs of wire within the UTP cable are broken up into transmit and receive pairs. The UTP cable used in network installations is the same type of cable used in the installation of telephone lines within buildings. UTP cabling is differentiated by the quality category of the cable itself, which is an indicator of the type and quality of wire used and the number of times the wires are twisted around each other per foot. The categories range from Category 1 to Category 5, with Category 5 cabling being of the highest quality.

The wires that make up a length of UTP cable are numbered and color coded. These color codes allow the installer of the networking cable to determine which wires are connected to the pins of the RJ45 ports or patch panels. The numbering of the wires in USOC standard cables is based on the color of the insulating jacket that surrounds the core of each wire.

Each jacket will have an overall color: brown, blue, orange, green, or white. In a 4-pair UTP cable (the typical UTP used in networking installations) there will be one wire each of brown, blue, green, and orange, and four wires whose overall color is white. The white wires will be distinguished from one another by periodically placed (usually within 1/2 inch of one another) rings of the other four colors.

Wires with a unique base color are identified by that base color: blue, brown, green, or orange. Those wires that are primarily white are identified as white/<color>, where <color> indicates the color of the rings of the other four colors in the white insulator.

The association of pairs of wire within the UTP cable jacket are decided by the specifications to which the cable is built. There are two main specifications in use around the world for the production of UTP cabling: EIA/TIA 568 and USOC. The two wiring standards are different from one another in the way that the wires are associated with one another throughout the cable.

The arrangement of the wires in the two specifications does not affect the usefulness of the resultant cables for Token Ring networking. The arrangement of the wires and pairs in the EIA/TIA and USOC specifications is discussed in the UTP Cable portion of the **Connector Types** section of this chapter.

While UTP cables are usually built to provide four pairs of wire, IEEE 802.5 standards only require the use of two pairs, referred to as Pair 1 and Pair 2 (Pair 1 and Pair 3 of the EIA/TIA 568A specification). Pair 2 of the connector is the transmit pair and Pair 1 of the connector is the receive pair. This organization of wires at the connector is referred to as a pinout. Pinouts will be discussed in greater detail in the **Connector Types** section of this chapter.

Table 9-2. IEEE 802.5 Wire Use

Wire Color	USOC Pair	Token Ring Signal Use	
		568A	568B
White/Blue (W-BL)	Pair 1	TX+	RX+
Blue (BL)	Pins 3 and 4	TX-	RX-
White/Orange (W-OR)	Pair 2	RX+	TX+
Orange (OR)	Pins 2 and 5	RX-	TX-
White/Green (W-GR)	Pair 3	Not Used	
Green (GR)	Pins 1 and 6		
White/Brown (W-BR)	Pair 4	Not Used	
Brown (BR)	Pins 7 and 8		

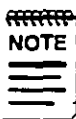

Do not split pairs in a twisted pair installation. While you may consider combining your voice and data cabling into one piece of horizontal facility cabling, the crosstalk and interference produced by this practice greatly reduces the viability of the cable for either application. The use of the pairs of cabling in this fashion can also prevent the future usage of advanced networking technologies that require the use of all four pairs in a twisted pair cable.

UTP cabling is produced in a number of overall quality levels, called Categories. The requirements of networking limit UTP cabling for Token Ring to Categories 3, 4, or 5. Any of these cable Categories can be used in a Token Ring installation, provided that the requisite IEEE 802.5 specifications regarding the cables are met.

Category 3

UTP cabling that is built to the Category 3 specification consists of two or more pairs of solid 24 AWG copper strands. Each strand, approximately 0.02 inch thick, is surrounded by a layer of insulation. The characteristics of the insulation are determined by the fire resistant construction of the cable (plenum cable is thicker and made with slightly different material than normal PVC cabling).

The individual wires are twisted into pairs. The twisted pairs of cable are laid together along with a thin nylon cord. This "ripcord" is useful for stripping the outer jacket of the cable, which may be low-smoke PVC plastic or a plenum-rated insulating material. The outer jacket surrounds, but does not adhere to, the wire pairs which make up the cable.

Category 3 UTP cabling must not produce an attenuation of a 16 MHz signal greater than 40 dB/305 m (1000 ft) at the control temperature of 20° C.

Category 4

Category 4 UTP cabling is constructed in the same manner as the Category 3 cabling discussed previously. Category 4 UTP is constructed using copper center strands of 24 or 22 AWG. Each strand is insulated and twisted together with another strand to form a pair. The resulting wire pairs are then covered by a second layer of insulating jacketing.

Category 4 UTP must not produce an attenuation of a 16 MHz signal greater than 27 dB/305 m (1000 ft) at the control temperature of 20° C.

Category 5

Category 5 UTP cabling is manufactured in the same fashion as Category 3 cable, but the materials used are of higher quality and the wires that make up the pairs are more tightly wound.

Category 5 UTP consists of 2 or more pairs of 22 or 24 AWG wire. Category 5 cable is constructed and insulated such that the maximum attenuation of a 16 MHz signal in a cable run at the control temperature of 20° C is 0.655 dB/m (25 dB/1000 ft). A cable that has a higher maximum attenuation than 0.655 dB/m does not meet the Category 5 requirements.

Fiber Optics

Fiber optic cable is a high performance media constructed of glass or plastic that uses pulses of light as a transmission method. Because fiber optics do not utilize electrical charges to pass data, they are free from the possibility of interference due to proximity to electrical fields. This, combined with the extremely low rate of signal degradation and dB loss makes fiber optics able to traverse extremely long distances. The actual maximums are dependent upon the architecture being used, but distances up to 10 km (6.2 miles) are not uncommon.

Glass optical fiber is made up of a glass strand, the core, which allows for the easy transmission of light, the cladding, a glass layer around the core that helps keep the light within the core, and a plastic buffer that protects the cable.

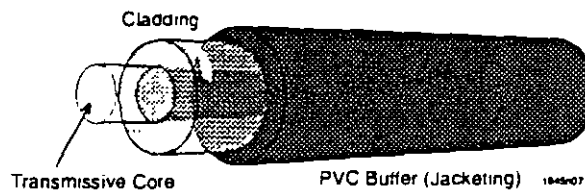

Figure 9-3. Fiber Optic Cable Construction

There are two basic types of fiber optics: multimode and single mode. The names come from the types of light used in the transmission process. Multimode fiber uses inexpensive Light Emitting Diodes (LEDs) that produce light of a single color. Due to the nature of the LED, the light produced is made up of a number of differing wavelengths of light, fired outward from the center of the LED. Not all the rays of light enter the fiber, and those that do often do so at an angle, which reduces the amount of distance the signal can effectively cover. Single mode fiber optics use lasers to achieve greater maximum distances. Since light from a laser is all of the same wavelength, and travels in a coherent ray, the resulting signal tends to be much clearer at reception than an LED signal under the same circumstances.

Fiber optics of both types are measured and identified by a variety of means. The usual means of referring to a fiber optic cable type is to identify if it is single mode or multimode, and to describe the thickness of each strand. Fiber optics are very thin, and the width of each strand is measured in microns (μm). Two measurements are important in fiber optic identification: the diameter of the core, where signals travel, and the diameter of the cladding, which surrounds the core. Thus, fiber optic measurements will usually provide two numbers separated by the "/" symbol. The first number is the diameter, in microns, of the core. The second is the diameter of the cladding. Thus, a 62.5/125 multimode cable is a type of fiber optic cabling with a 62.5 micron core and 125 micron cladding, which can be used by inexpensive LED equipment, as it allows multiple modes of light to pass through it. Incidentally, 62.5/125 μm multimode cabling is a very common type of fiber optics.

In much the same way that UTP cabling is available in two-, four-, 25-, and 50-pair cables, strands of fiber optic cabling are often bound together with other strands into multiple strand cables. These multiple strand cables are available with anywhere from two to 24 or more strands of fiber optics, all gathered together into one protective jacket.



Cabletron Systems recommends that customers planning to install fiber optic cabling not install any facility fiber optics (non-jumper cabling) containing fewer than six strands of usable optical fiber. The minimum number of strands needed to make an end-to-end fiber optic link between two network devices is **two**. In the event that a strand within the cable is damaged during installation or additional fiber pairs become desired along the cable path, the availability of extra strands of optical fiber will reduce the likelihood that a new cable must be pulled. The existing, unused pairs of optical fiber can be terminated and used immediately.

Multimode

Multimode fiber optic cabling is designed and formulated to allow the propagation of many different wavelengths, or modes, of light. Multimode fiber optics are the most commonly encountered fiber type in network installations, due to their lower cost compared to other fiber types.

Token Ring fiber optic devices that meet the IEEE 802.5j specification are terminated with ST connectors. Older network installations may utilize the IBM biconic connector or the Sub-Miniature Assembly (SMA) connector.

Single Mode

Single mode fiber optics are designed specifically to allow the transmission of a very narrow range of wavelengths within the core of the fiber. As the precise wavelength control required to accomplish this is performed using lasers, which direct a single, narrow ray of light, the transmissive core of single mode fiber optics is typically very small (8 to 12 μm). Single mode fiber is more expensive to produce than multimode fiber, and is typically used in long-haul applications.

Due to the very demanding tolerances involved in connecting two transmissive media with diameters approximately one-quarter as thick as a sheet of paper, single mode fiber optics require very precise connectors that will not move or shift over time. For this reason, single mode fiber optics should only be terminated with locking, preferably keyed, connectors. Token Ring fiber optic installations must use the ST connector to be compliant with the IEEE 802.5j specification.



About ATM

This chapter discusses the evolution and promise of ATM as a multiple media networking technology, and gives simple explanations for what ATM is and what it does.

Introduction to ATM

There are two basic types of communication networks: public networks and private networks. Public networks are owned and operated by telephone companies and television cable companies, and provide worldwide access to voice, data, and video communication services. They are considered to be public because this network can be accessed from anywhere in the world when a user decides to pick up a telephone, turn on a television, or gain access to the internet through a computer and modem.

Private networks such as Local Area Networks (LANs) are owned, operated and controlled by corporations, companies, government agencies and universities. These LANs were once geographically isolated to individual companies or sites. Today these same networks use public networks as intermediate connections to other private networks. LANs are mainly data communications networks, but are recently beginning to transmit more and more broadband communications like voice and video.

Both public and private networks process large amounts of information. These networks provide reliable service and good response time. However, as bandwidth demands for greater speed, efficiency, and reliability, an emerging technology called Asynchronous Transfer Mode (ATM), has matured to fulfill the networking requirements of modern public and private computer networks.

Where ATM Started

Telecommunications carriers were the first to develop ATM. The goal of their project was to define and standardize a transmission over any synchronous channel that would unite media services and deliver them in a fast, inexpensive, reliable and efficient manner. Once the ATM technology met these goals, it became the vehicle for a Broadband-Integrated Services Digital Network (B-ISDN), which is a digital transmission standard defining communication protocols permitting telephone networks to carry data streams over Wide Area Networks (WANs).

Carriers understand the need for a medium to carry broadband communications over a high-capacity network, because they are interested in reducing the cost and number of different networks that they must maintain for a variety of users. These different networks are becoming expensive to operate and support as the demand for bandwidth rises. For this reason, ATM has become an attractive networking technology for both WAN carriers and LAN environments. It provides high bandwidth and does not use network capacity unless there is information to be sent. When there is information to be sent, it is packaged into cells that travel along an assigned channel. When a particular device is not transmitting, the spare capacity can be used by other devices. When no devices are transmitting, the channel is filled with idle cells.

By allocating only the bandwidth needed by a user's applications, ATM could lead to greater network efficiency and productivity in LAN environments with significant cost savings. In the future, Native ATM technology (ATM networks without connected legacy networks) has the potential to make both LANs and WANs more transparent by offering a homogenous connection between any two points on the globe. This connection would be direct, without having to be routed or bridged over different technologies before finally making a link.

One of the important questions facing network designers examining ATM technology is "how will it fit into my existing network"? Due to the relative expense and the pre-standardized nature of the ATM technology, ATM is being gradually implemented into today's LANs, most often as a backbone technology.

ATM Workgroups and LAN Backbones

ATM backbones currently used in LANs create high-speed communication links between users in different workgroups or between different users located in different areas. Backbones are the central transmission media of larger networks carrying large amounts of data at high speeds.

ATM is becoming more widely accepted as a LAN backbone technology, but its transition has not been smooth due to the complexity of the technology needed to mesh ATM backbones with existing Ethernet, Token Ring, and FDDI LANs. The slow adoption of LAN Emulation, and the status of specifications for Classical IP have complicated the migration to ATM backbones for some users. However, ATM's speed and ability to multiplex different communication media types makes it an attractive networking solution.

ATM backbones provide high transmission speeds and bandwidth in a way that supports user mobility, easily modified workgroup connectivity, and the base of existing network-oriented applications in LANs. As a LAN backbone, ATM is used to connect centralized workgroup hubs supporting hundreds of connections. ATM provides large amounts of bandwidth and is implemented as high-speed switching matrixes within the backplane of ATM switches and next generation smart hubs. Within the backplane, ATM will provide the high-speed interconnection between modules and networks in the same manner as used in the physical backbone, essentially bringing the ATM backbone network into the switch or smart hub. ATM used as a WAN backbone solution can have the capacity to carry transmissions between major cities, states, or countries. ATM WANs are currently being implemented by some telecommunications carriers. It is quite likely that this event will spark even more implementations in LAN backbones in the near future.

The Promise of ATM

If the computer industry had the ability to turn back time and start with a clean slate concerning computer networking, it might well have gone with Native ATM. Most of the ATM concepts and features discussed in this guide would be optimized in any type of data applications. ATM has been an evolving technology that has taken years (1991-1997) of network development, investment and implementation to migrate and complement sizable, established, legacy-network environments.

Although ATM has shown much promise in its goals for wide-spread implementation in both LANs and WANs as a far reaching and revolutionary network solution, it has gone through some growing pains. The acceptance and implementation of ATM has been gradual because of its cost, development, and investment in existing networking technologies. Network designers are beginning to utilize ATM backbone switches for their existing networks where it has made the most practical and cost-effective sense. The type and volume of traffic may also affect decisions to use ATM as a networking solution. ATM may be a more practical networking approach for users that have high multimedia traffic or exceedingly high-bandwidth demands.

The hope of implementing Native ATM in all networks over time rests in encouraging the technology to migrate and coexist with legacy LANs and WANs until it gradually positions itself to live up to its potential as a unifying technology. Native ATM to the desktop will win wide-spread acceptance when applications drive users to find a faster, more capable transport service. ATM to the desktop will become more widespread when an ATM infrastructure that supports it becomes more fully developed in both LANs and WANs.

In WANs, carriers have the resources to create a major ATM infrastructure, and are motivated to do this because ATM "flattens the network," decreasing the number of multiple separate networks they need to support. Carriers are now investing in equipment to upgrade their infrastructure and are buying ATM WAN and LAN switches along with other access devices to build ATM networks that pave the way for a single, high-speed, and universal networking architecture that is compatible with current and planned electrical and optical cables.

Interoperability, the Ideal of Networking

Ideally, all devices placed on any network should be able to transfer information in a usable fashion and understandable format to any other station. For some time, however, this was not always the case. Different companies, even within the same industry, have different ways of designing, developing, and constructing their products. Different views of how a network should operate led to radically different products and methods of networking. These early networking implementations were specific to one particular vendor, and would often only work in homogenous environments, where all components used in the network were produced by that single vendor. This method of networking locked customers in to relying on a single vendor for all their networking needs, current and future, which could lead to problems if the network implementation was unsatisfactory. Replacing all present networking equipment with the proprietary solution of another vendor is an extremely costly proposition.

To combat this, the idea of interoperability grew in popularity. Ideally, interoperability means that the networking devices of Vendor X can communicate, problem-free, with the networking devices of Vendor Y.

Standards and Compliance

Interoperability requires the following of standards: distinct rules and finite margins within which network operation and performance must be kept. If a network does not meet the minimums, or exceeds the maximums of the networking standard that the industry uses, it is said to be "out of specifications," and may not operate at an acceptable level.

Standards are defined by committee through the operation of standards institutes. Standards institutes are made up of personnel from several firms in the industry who volunteer their time and effort. These volunteers work to compose and ratify an acceptable standard that must be met by any product that refers to itself as "standards-compliant." Products that are not standards-compliant may cause or experience interoperability problems when operating in a standards-based network. Of course, even in a fully standards-based network, there may still be problems. Most vendors in the industry realize the importance of providing a flexible and open network to all customers, and they seek to eliminate any interoperability problems they notice.

The OSI Model, Basis of Standards

The International Organization for Standardization (ISO) Open Systems Interconnect (OSI) Model provides a framework for the development of system connection standards by defining a consistent hierarchy of rules. The OSI model defines where the needed tasks of system interconnection are performed but not *how* they are performed. How tasks are performed on a given layer is determined by the protocols, or rules, written for that particular network based on the OSI model. The layers may be implemented in hardware, software, or both. Each layer in a network based on the OSI model performs specific types of functions required for proper system interconnection.

There are seven layers in the OSI Model (see Figure 2-1). They begin with the Physical Layer and end with the Application Layer. Each layer provides services to the layer above it. As the seventh layer is the 'topmost' layer, it serves the user directly, and is considered the top of the OSI model.

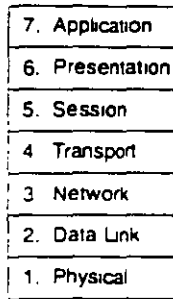

2059-01

Figure 2-1 OSI Model

Layer Seven: Application

The Application Layer is the user's interface with the network. This layer directly interacts with user application programs to provide access to the network. All other layers exist to support the requirements of the Application layer. The Application layer is usually involved with network-oriented end-user tasks such as electronic mail, network file transfers, and collaborative document preparation.

Layer Six: Presentation

The Presentation Layer deals with data translation and code conversion between devices with different data formats (i.e., ASCII to EBCDIC). This layer also handles translation between differing device types and file formats, as well as data encryption and decryption services. In the transmit mode, the presentation layer passes information from the application layer to the Session layer after it has appropriately modified or converted the data. In the receive mode, the Presentation layer works in reverse passing information from the Session layer to the Application layer.

Layer Five: Session

The Session layer manages the communications dialogue between two communicating devices. The Session layer establishes rules for initiating and terminating communications between devices and can provide error recovery.

Layer Four: Transport

The Transport layer deals with the optimization of data transfer from source to destination by managing network data flow and implementing the quality of service requested by the Session layer. The Transport layer determines the packet size requirements for transmission based on the amount of data to be sent and the maximum packet size allowed by the network architecture. If the data to be sent is larger than the maximum packet size allowed on the network, the Transport layer is responsible for dividing the data into acceptable sizes and sequences each packet for transmission.

When receiving data from the Network layer, the Transport layer ensures that the data is received in order and checks for duplicate and lost packets. If data is received out of order, the Transport layer correctly orders the data and passes the data up to the Session layer for additional processing.

Layer Three: Network

The Network layer accepts data from the Transport layer and adds the appropriate information to the packet to provide proper network routing and some level of error control. Data is formatted by this layer for the appropriate communications protocol, such as IP, IPX, or X.25.

Layer Two: Data Link

The Data Link layer is involved with transmission, error detection, and flow control of the data. The major function of the Data Link layer is to act as a shield for the higher layers of the OSI model, controlling the actual processes of transmission and reception. Error detection and control of the Physical layer are the primary functions of this layer, ensuring that data received by the upper layers is error-free. For purposes of understanding networking, it is useful to divide the Data Link layer into two sub-layers: the Logical Link Control layer and the Media Access Control layer (see Figure 2-2).

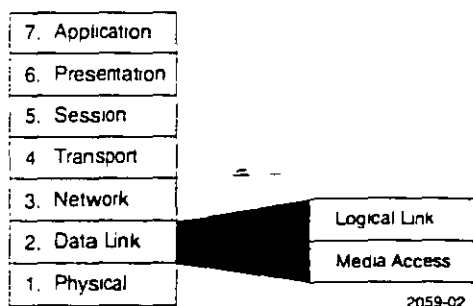

Figure 2-2 Data Link Layer

Logical Link Control

The Logical Link Control Sublayer shields the upper layers from any particular access method or media. The upper layers are not concerned about whether they are connected to a Token Ring or Ethernet network because the Logical Link Control Sublayer handles the interface. The Logical Link Control provides for a common interface of the layers above to any physical network implementation.

Media Access Control

The Media Access Control, or MAC, Sublayer is responsible for several areas of operation. On the transmit side, the MAC Layer receives data from the Logical Link Control Sublayer and encapsulates it into a packet ready for transmission. The MAC Sublayer determines if the communications channel is available for handling retransmission in the event of a collision on some networks.

Layer One: Physical

At this layer, the transmission media is defined. That definition includes cables and connectors, connector pinouts, voltage levels that represent digital logic levels, bit timing, and the actual network device interface.

Application of the OSI Model

A user's perception of network operation appears as direct peer-to-peer communications. The user message appears to go from the sending application directly to the receiving application. In actuality, the user message is routed from the sending application down through the other OSI Model layers of the system (see Figure 2-3). Each layer adds to or modifies the message according to the network operating system's protocol for each layer. The message passes through all the layers of the system before appearing on the data channel at the Physical layer, where transmission and reception of signals takes place.

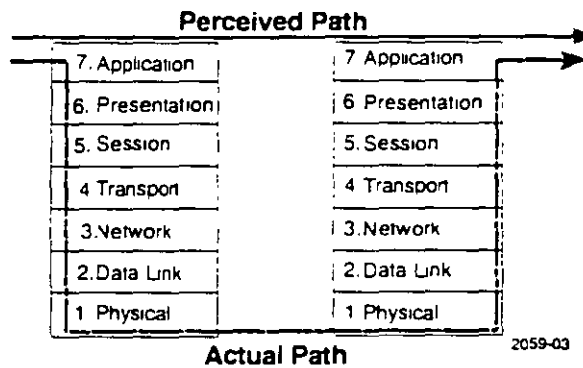

Figure 2-3 Transmission through OSI Model

From the data channel the message passes upward through the same layers at the destination device. As the message proceeds from layer to layer, each layer strips off information that was added by its counterpart in the transmitting station. The result is the message as it was originally sent, arriving at the destination station's Application Layer.

ATM Model

The ATM model provides a framework for the development of system connection standards similar to the OSI model. The ATM model borrows the upper four layers of the OSI model without change, however, from the Network Layer down, the ATM model uses a completely different framework for the way connection standards are developed and implemented. It is important to keep in mind that the ATM Adaptation Layer (AAL), ATM Layer, and the Physical Layer provide a new framework designed to accommodate ATM technology similar to the way the Network, Data Link, and Physical Layers are used as a framework to accommodate standards for Ethernet, Token Ring, and FDDI networking technologies. It is also important to understand that the ATM Adaptation Layer, for example, does not necessarily replace or dismiss Network Layer functions. Figure 2-4, shows how the OSI and ATM models relatively compare to one another considering the basic framework for each model.

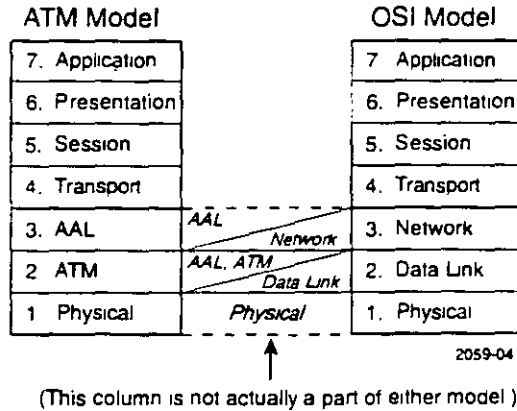

Figure 2-4 ATM and OSI Models

ATM Adaptation Layer

The ATM Adaptation Layer (AAL) translates and provides a path between the ATM Layer and higher layers. As information passes down the ATM model, the AAL converts and breaks up user information (Protocol Data Units) into 53-byte cells. The reverse process occurs when the AAL converts and reassembles cells into Protocol Data Units as user information passes up the ATM model layers.

The ATM Adaptation layer is designed to reduce the amount of overhead functions for which a network would otherwise be responsible. The purpose of the AAL is to allow most of the overhead functions, like the segmentation and reassembly process, to occur on the end system of a Virtual Channel Connection (VCC), like a Native ATM workstation, and not on the ATM switches themselves. The AAL contains the Convergence Sublayer (CS) and the Segmentation and Reassembly (SAR) sublayer. Figure 2-5 shows a more detailed view of the lower ATM model layers and their sublayers.

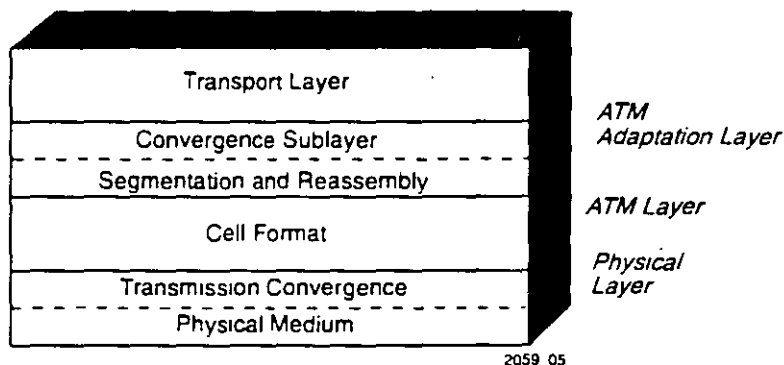

Figure 2-5 ATM Adaptation Layer, ATM Layer, and Physical Layer

The Convergence Sublayer prepares the higher layer data for conversion to cells. User information is then divided into segments suitable for packaging in a series of cells for transmission between the endpoints of the communications process by the Segmentation and Reassembly Sublayer. This sublayer segments the received data from the CS into 44, 47, or 48 byte cell data fields depending on the type of ATM adaptation layer service classification they are being prepared for.



Depending on the adaptation process, not all 48 bytes of the data field are required to be user information and up to four bytes can be used by the adaptation process itself.

For the incoming cell, the Segmentation and Reassembly Sublayer and Convergence Sublayer rebuild the cells into data that can be processed by the higher layers, such as the Transport, Session, Presentation, and Application Layers. How and which ATM Adaptation Layer process is used and completed depends on the type of traffic being transmitted. The AAL is what liberates the network from concerning itself with different traffic types, and it is the ATM Layer's responsibility to route cells from one point to another based on the information contained in the header. The AAL also provides extra services including recovery of clocking information, error correction, retransmission and support for specialized ATM.

Quality of Service Issues

When an ATM station connects to the ATM network, it arranges a contract with the network based on Quality of Service (QoS) specifications. This contract specifies an envelope that describes the user's traffic flow parameters specified by the ATM Forum User-to-Network Interface (UNI) 3.0, 3.1, and 4.0 specifications. These specifications include the traffic type, cell loss ratio, sustained and peak bandwidth, burst length, and Quality of Service class. The Quality of Service parameter also requires timing Cell Transfer Delay (CTD) and Cell Delay Variation (CDV). Both parties negotiate and agree on a Quality of Service contract when it is determined what the ATM network can provide, and what the transmission requirements are of the user.

ATM Adaptation Layer Service Classification

The ATM model currently has three different classes of Adaptation Layers in use. Each of the ATM Adaptation Layer classifications is based on the service requirements of the information being transferred or received from either higher or lower layers of the ATM model. Table 2-1 shows the three different classes of information categorized under the Broadband-Integrated Services Digital Network (B-ISDN) standard for the ATM Adaptation Layer. B-ISDN is the digital standard defining communication protocols allowing telephone networks to carry data, voice, and video over Wide Area Networks (WANs).

Each class of the ATM Adaptation Layer is identified by two factors: the type of bit rate and the connection mode, which can provide a constant or variable bit rate service, and a connection or connectionless-orientated mode of operation. Table 2-1 shows the characteristics and services supported by each ATM Adaptation Layer.

Table 2-1. ATM Adaptation Layers

Characteristics	AAL1	AAL3/4	AAL5
Timing relationship between source and destination	required		not required
Bit rate	constant		variable
Connection mode	connection oriented		connection oriented connectionless
Traffic types	voice, video and channel emulation		data
Class	Class A (voice) Class B (video)		Class C and D (data)



ATM Adaptation Layer 2 is no longer being used. AAL2 was designed to support variable bit rate service for synchronous, time-sensitive compressed video traffic. This function is currently accomplished by ATM Adaptation Layer 3/4.

A constant bit rate is intended for services requiring guaranteed synchronous timing or clocking between source and destination endpoints, and are usually voice and video transmissions. A variable bit rate is intended to let the bit rate change as the service requirement changes. This service is ideal for data because of its bursty nature and tolerance of delay. In other words, the timing requirement between two endpoints on a network does not have to remain constant.

A connection-oriented mode, like ATM, uses a deterministic access method similar to a telephone call in a public network where the call is set up and the connection is established before information is transferred. During the call setup procedure, special cells hold addressing information in their data fields that is accessed by the network to create a connection. However, when data is being transmitted over an established connection, only the 5-byte cell header needs to be referenced by an ATM switch, to direct information across the Virtual Channel Connection instead of the cell's 48-byte data field.

Most legacy LANs, such as Token Ring, Ethernet, and FDDI, have a connectionless mode of operation that uses a shared-medium access method among all attached devices. A protocol procedure organizes the sharing process and allows all network devices to use the medium.

When data is shared between connection-oriented and connectionless networks, a procedure must be accepted and used, before they can work with each other. The connectionless-mode is supported by AAL3/4 and AAL5, and works together with the LAN Emulation protocol to set up an ATM connection. For more information on the LAN Emulation protocol, refer to Chapter 7, **ATM in the LAN**.

ATM Layer

The ATM Layer is responsible for all cell header processing. This layer makes all indentifications of ATM connections, and provides all cell multiplexing and demultiplexing services. The ATM Layer is also where cell construction and processing occurs.

Physical Layer

The Physical Layer defines the physical interface on which the ATM Layer will be running. It takes care of all error control sequences, and places idle cells in the transmitting time slots while stripping them from received time slots. The Physical Layer is concerned with bit transmissions and coding schemes, and generates or recovers time slots. The ATM Physical Layer is designed to work with any existing physical media specification.

ATM Standard Making Bodies

Currently, there is not one accepted standard for ATM, but there are specifications being established for it. The International Telecommunications Union-Telecommunications (ITU-T) is a standards making body that sponsors the American National Standards Institute (ANSI). ANSI is a smaller standards body working within ITU-T that develops world-wide telecommunication and data communication documents and specifications. It is responsible for making a standard for ATM. The Internet Engineering Task Force (IETF), another standards making body, is responsible for creating various addressing protocols for ATM.

Specifications working toward the implementation of a standard have been maintained and put forward by a group called the ATM Forum. The ATM Forum's goal has also been to accelerate the deployment of ATM products and services through interoperability specification. It was formed in October 1991 as an impromptu organization of carriers, network equipment providers, semiconductor vendors, government agencies, research groups and customers. focused on creating specifications for a single standard. The group has now grown to 900 members making a combined effort to cooperate and agree on specifications before standards are finally set by the ITU-T, ANSI, and the IETF. The ITU-T standard body recognizes the ATM Forum as a credible group working towards this goal. The rationale among different groups for building consensus through the ATM Forum is to ensure that once ATM technology has a set standard, their products and technology adhere to them without becoming proprietary or obsolete. Once a set standard is in place, how well ATM networks operate depends largely on the architecture and design chosen by the various vendors for their ATM products.

The ATM Forum has drafted the User to Network Interface (UNI) specification that became the foundation upon which several other baseline specifications were built. Many of the key baseline specifications are complete and consist of the following: LAN Emulation (LANE), channel emulation, audio/visual multimedia service, Native ATM services, testing specifications, and support of frame relay, Switched Multi-megabit Data Services (SMDS) and Internet Protocol (IP) over ATM.

Cabletron Supported Specifications

Cabletron Systems products currently support some or all of the following ATM specifications:

- LAN Emulation (LANE v1.0)
- User-to-Network Interface (UNI v3.0/3.1/4.0)
 - Switched Virtual Channel Signaling (Q.2931)
 - Interim Local Management Interface (ILMI)
 - Address Registration
 - Physical Layer Specifications
- RFC 1483 – IETF Multi-Protocol Encapsulation over AAL5
- RFC 1577 – Classical IP
- RFC 1695 – AToM MIB

In addition, a number of widely used proprietary implementations are supported by Cabletron Systems in order to ensure the maximum interoperability in heterogeneous networks.



DIPLOMADO EN REDES DE
COMPUTADORAS (LAN, WAN Y GAN)

CABLEADO ESTRUCTURADO
(INGENIERIA Y CERTIFICACION)

Diagnostico y Cerificación

Requisitos y proceso de certificación de POUYET DE MÉXICO, S.A de C.V.

CERTIFICACION A PERSONA CAPACITADA EN LA INGENIERIA E INSTALACION DEL SCQ:

La persona certificada tendrá(a que aprobar satisfactoriamente con una calificación mínima de 8 00 puntos (en escala de 0.00 a 10.00 puntos) un curso denominado "curso de certificación de Sistemas Avanzados de Cableado Estructurado SCQ-POUYET", el cual será impartido por POUYET MEXICO, S.A DE C.V., u otra Institución Especializada (un tercero) debidamente aprobado por POUYET MEXICO, S.A. DE C.V., que cuente con su contrato vigente.

1) Entre los requisitos básicos para poder inscribirse al curso de certificación son:

1.1 Presentar una copia del curriculum vitae que incluya la siguiente información:

- Datos generales
- Formación académica
- Experiencia laboral
- Objeto(s) principal(es) de la certificación

1.2 Adquirir el material del curso, guía de ingeniería, muestras, etc.

2) Entre los requisitos básicos para iniciar el curso de certificación serán:

- Cubrir los requisitos anteriormente descritos
- Haber aprobado satisfactoriamente con un mínimo de 6 00 (en escala de 1.00 a 10.00) el examen inicial el cual será basado en la guía de ingeniería.

3) Para lograr el certificado es necesario cumplir cuando menos con los requisitos siguientes:

- Asistir puntualmente a las sesiones.
- Cubrir un 95% de la asistencia.
- Aprobar satisfactoriamente el examen teórico práctico con una calificación mínima de 8 00 (en una escala de 0.00 a 10.00)

NOTAS.

El certificado tendrá una validez por 12 meses y no será renovable automáticamente por ello será necesario realizar un curso de actualización.

El derecho de admisión es a criterio de la empresa que imparte el curso.

CERTIFICACION POR COMPAÑIA:

Requisitos previos a cumplir:

La empresa a certificar deberá contar con un mínimo de 2 personas certificadas con POUYET MEXICO.
Enviar un curriculum de la empresa que contenga los siguientes puntos:

- Instalaciones realizadas (fecha, nombre del cliente, dirección, teléfono, tipo de instalación)
- Productos instalados (marcas)
- Enviar copia del acta constitutiva incluyendo las últimas modificaciones y copia de su RFC.
- Objetivo al solicitar la certificación
- Volumen de compras estimadas por los 12 primeros meses.
- Copia de los certificados vigentes otorgados a cuando menos 2 personas.

NOTAS:

- Pouyet de México se reserva el derecho de otorgar la certificación.
- El certificado tendrá una validez por 12 meses y no será renovable automáticamente y será válido durante la vigencia del presente contrato.
- La empresa que tenga certificación vigente, deberá en todo momento presentarse como tal y en las tarjetas del personal de ventas, ingeniería y mantenimiento tendrá que utilizar el logotipo que le corresponda.

CERTIFICACION A OBRA (para integradores certificados).

Información que POUYET MÉXICO le solicitará para definir una fecha de inspección para pruebas que realizará nuestro perito al fin del proceso de la certificación.

1 Datos del cliente final:

- Razón Social
- Dirección de la Razón Social
- Dirección de la instalación.
- Responsable
 - ✓ Cargo
 - ✓ Teléfono

2 Planos esquemáticos de la instalación

3 Memoria técnica

Cuando menos debe contener:

- Breve descripción de los productos
- Diagrama esquemático de la red
- Descripción gráfica de los distribuidores(principal y/o secundario)
- Descripción para la nomenclatura utilizada para la identificación
- Certificación del 100% de las formas FIRMADAS avaladas de su correcta instalación por el técnico responsable de la instalación por parte de Integrador de Sistemas Certificado.
 - a) Esta certificación por lo tanto se hará en base a la norma mundial de cableado ISO/IEC 11801 vigente en el año del presente contrato
 - b) El analizador (scanner) deberá hacer el estudio según el boletín técnico TIA, TSB-67 Nivel II o superior, mostrando el margen de la medición en decibeles (dB) para cada combinación de pares (paradifonía o NEXT) y atenuación.

Responsable del mantenimiento y/o adiciones por parte del integrador de sistemas.

El documento deberá tener todas sus hojas foliadas, estando este engargolado, encuadernado o usando algún otro método para la correcta presentación del mismo y las páginas numeradas o foliadas.

La empresa deberá contar con un certificado vigente de certificación de POUYET.

Anexar una relación de todos los productos incluyendo el nombre del distribuidor donde fueron adquiridos los productos.

NOTAS

Pouyet de México, S.A. de C.V. se reserva el derecho de otorgar la certificación o cualquiera de los siguientes motivos:

- Falta de cualquiera de los requisitos arriba indicados
- Por no utilizar todos los productos de la marca Pouyet
- Por no adquirir los productos SCQ con su distribuidor correspondiente.

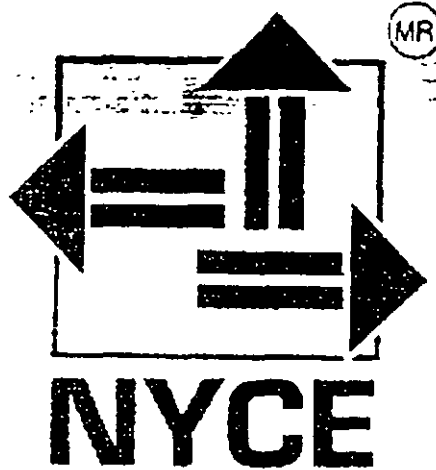

NORMALIZACION Y CERTIFICACION ELECTRONICA, A.C.

NORMA MEXICANA

NMX-I-248-1998-NYCE

TELECOMUNICACIONES – CABLEADO – CABLEADO ESTRUCTURADO – CABLEADO DE
TELECOMUNICACIONES PARA EDIFICIOS COMERCIALES – ESPECIFICACIONES Y METODOS
DE PRUEBA

5.9.2 Requerimientos para cables de 100 Ω .

Los cables de 100 Ω se clasifican en categorías 3, 4 y 5 de acuerdo a la frecuencia máxima hasta la cual están especificadas sus características de transmisión. En 5.9.2.1 se indican los requerimientos comunes a todas las categorías.

5.9.2.1 Requerimientos generales para cables de 100 Ω .

Los cables de 100 Ω deben cumplir con NMX-I-236-NYCE.

5.9.2.2 Código de colores

El código de colores para un cable de 4 pares, debe ser como se muestra en la tabla 3: par 1 Azul- blanco; par 2 Naranja-blanco; par 3 Verde-blanco; par 4 Café-blanco.

Se debe aplicar el código de colores de la norma NMX-I-236-NYCE, para cables de más de 4 pares.

TABLA 2.- Características constructivas para cable de cobre de 100 Ω.

Característica	Valor
a) Diámetro del conductor (mm)	0,50 – 0,64
b) Diámetro sobre aislamiento (mm)	1,2 mm ¹
c) Blindaje alrededor de los pares	opcional (véase capítulo de blindaje)
d) Número de pares:	
secundario (horizontal)	4 ó mas
Vertebral (backbone)	2,4 ó mas
e) Diámetro máximo del cable:	
secundario (horizontal) (mm)	6,5
Vertebral (backbone)	30
f) Radio de curvatura:	
Cableado Horizontal	8 veces el diámetro del cable
Durante la instalación	4 veces el diámetro del cable
Ya instalado	
g) Radio de curvatura:	
Cableado Vertebral	8 veces el diámetro del cable
Durante la instalación	6 veces el diámetro del cable
Ya instalado	
h) Tensión para instalación ²	50 N/mm ² de área de cobre
i) Categoría de prueba de flama:	Según el tipo de instalación de acuerdo a NOM-0001-SEMP
NOTAS:	
1 Algunos conectores aceptan diámetros sobre aislamiento máximo de 1,0 mm.	
2 Este límite se establece para evitar que el desempeño del cable se degrade durante la instalación.	

TABLA 3.- Código de colores para cableado horizontal con cable de par trenzado de 100 Ω

Identificador del conductor	Código de colores	Abreviación
Par 1	Bianco-Azul (nota 1) Azul (nota 2)	(B-A) (A)
Par 2	Bianco-Naranja (nota 1) Naranja	(B-N) (N)
Par 3	Bianco-Verde (nota 1) Verde (nota 2)	(B-V) (V)
Par 4	Bianco-Café (nota 1) Café (nota 2)	(B-C) (C)
NOTAS:		
1 El aislamiento es de color blanco y se identifica el cable con una marca de color, para cables con un trenzado muy pegado (todos los pares trenzados a menos de 38,1 mm) el conductor de color puede servir de identificador del par.		
2 Una marca blanca es opcional.		

5.9.2.3 Características eléctricas de los cables de 100 Ω.

5.9.2.3.1 Parámetros primarios

TABLA 4.- Parámetros primarios para cable de cobre de 100 Ω.

a) Resistencia óhmica máxima	9,38 Ω/100 m a 20°C
b) Desbalance de resistencia máximo	3%
c) Capacitancia (nF/100 m):	6,6 para categoría 3 5,6 para categorías 4 y 5
d) Desbalance capacitivo a tierra	330 pF/100m máximo
e) Resistencia de aislamiento mínima	1 500 MΩ-100 m
f) Rigidez dieléctrica mínima(c)	1 kV 1 min ó 2,5 kV 2s

5.9.2.3.2 Características de transmisión

Las características de transmisión para cable de cobre de 100 Ω deben ser de acuerdo con lo que se establece en la tabla 5.

TABLA 5.- Características de transmisión para cable de cobre de 100 Ω

Categoría	3	4	5
a) Impedancia (nota 1)		100 ± 15 Ω	
b) Atenuación a: (dB/100 m a 20°C)			
64 kHz (nota 2)	0,9	0,8	0,8
256 kHz	1,3	1,1	1,1
512 kHz	1,8	1,5	1,5
1 MHz	2,6	2,2	2,1
4 MHz	5,6	4,3	4,1
10 MHz	9,7	6,9	6,5
16 MHz	13,1	8,9	8,2
20 MHz	NA	10,0	9,3
31,5 MHz	NA	NA	11,7
62,5 MHz	NA	NA	17,0
100 MHz	NA	NA	22,0
c) Atenuación mínima de paradiafonía dB en 100 m de cable(nota 3):			
150 kHz	53	68	74
772 kHz	41	56	64
1 MHz	41	56	62
4 MHz	32	47	53
10 MHz	26	41	47
16 MHz	23	38	44
20 MHz	NA	36	42
31,25 MHz	NA	NA	40
62,5 MHz	NA	NA	35
100 MHz	NA	NA	32

4-7

Tabla 5 (continúa)

d) Pérdida mínima de retorno dB en 100 m de cable 1-10 MHz	12	21	23
10-16 MHz	10	19	23
16-20 MHz	NA	18	23
20-100 MHz	NA	NA	23-10Log f/20
e) Retraso de propagación a 10 MHz (ns/m máximo)	5,7	5,7	5,7

NOTAS:

- 1 Se debe cumplir con el valor de impedancia a las frecuencias desde 1 MHz y hasta la máxima aplicable a cada categoría.
- 2 Se indican los valores de atenuación a las frecuencias de interés. para calcular el valor a otras frecuencias dentro del límite de operación para cada categoría, se debe usar la siguiente fórmula:

$$\text{Atenuación (f)} = K1 (f)^{1/2} + K2f + K3/(f)^{1/2}$$

Donde

f es la frecuencia de la señal y las constantes:

	K1	K2	K3
Categoría 3	2,320	0,238	0,000
Categoría 4	2,050	0,043	0,057
Categoría 5	1,967	0,023	0,050

- 3 La paradiafonía se especifica a partir de 772 kHz y hasta la frecuencia máxima aplicable a cada categoría. para calcularlo a una frecuencia (f) se usa la siguiente fórmula:

$$\text{Paradiafonía NEXT (f)} = \text{NEXT}(772) \cdot 15 \text{ Log}(f/772)$$

El valor de paradiafonía a 150 kHz se da sólo como comparación con cables para uso en telefonía.

Los valores eléctricos primarios de 5.9.2.3.1 son una guía de diseño, y pudieran tener variaciones siempre y cuando se cumplan las características de transmisión. Los parámetros de transmisión de 5.9.2.3.2 son los que determinan el desempeño del cable con la categoría correspondiente.

5.9.3 Cordones de interconexión (patch cord)

Están diseñados para usarse en los tableros de distribución o para la conexión final entre la salida en la estación de trabajo y el equipo terminal. Estos cordones deben cumplir con las mismas características de 5.9.2 con las siguientes excepciones:

5.9.3.1 Conductor

El conductor debe ser multifilar para mayor flexibilidad, equivalente al conductor sólido correspondiente y el paso de reunión de los alambres no debe ser mayor a 15 mm.

5.9.3.2 Atenuación

La atenuación del cable debe cumplir con la categoría correspondiente, de acuerdo a la tabla 6.

TABLA 6.- Atenuación de cordones multifilares (db/100 m a 20 °C)

Frecuencia (MHz)	Categoría 3	Categoría 4	Categoría 5
0,064	1,1	1,0	1,0
0,255	1,6	1,6	1,3
0,512	2,2	1,8	1,8
0,772	2,7	2,3	2,2
1	3,1	2,6	2,4
4	6,7	5,2	4,9
10	11,7	8,3	7,8
16	15,7	10,7	9,9
20	NA	12,0	11,1
31,5	NA	NA	14,1
62,5	NA	NA	20,4
100	NA	NA	26,4

NOTA: Estos valores corresponden a un incremento de 20 % respecto a los valores para cable con conductor sólido.

5.9.4 Accesorios de conexión

5.9.4.1 General

Aquí se especifican los requerimientos de rendimiento mecánicos y de transmisión, para los accesorios de conexión que sean consistentes con los cables de cobre especificados en 5.9.2 y 5.9.3. Esta subcláusula contiene el conjunto mínimo de parámetros y sus límites asociados necesarios, para asegurar que los conectores instalados adecuadamente tengan un efecto mínimo sobre el rendimiento del cable. Estos requerimientos se aplican únicamente a conectores y ensambles de conectores individuales, que incluyen, pero no están limitados a salidas/conectores de telecomunicaciones, paneles de parcheo, conectores de transición y bloques de conexión cruzada.

Debe hacerse notar, que los requerimientos para los conectores categoría 3, 4 y 5, no son suficientes por sí mismos para asegurar el rendimiento requerido del sistema de cableado. El rendimiento del enlace también depende de las características del cable que incluye puentes de conexión cruzada y cordones de parcheo, el número total de conexiones y el cuidado con el que son instalados y mantenidos. Para los lineamientos y requerimientos sobre las prácticas de terminación de conectores, administración del cable, el uso de cordones de parcheo o puentes de conexión cruzada y de los efectos de conexiones múltiples, véase 5.9.5.

Los accesorios deben ser del tipo de contacto de desplazamiento del aislamiento (IDC).

Se instalan accesorios de conexión para el sistema de cableado en los siguientes puntos;

- a) Conexión cruzada principal;

ETHERNET

Tecnología	Velocidad (Mbps)	Cables	Distancias
10base-T	10	UTP categoría 3.5	100 m
10base2	10	Coaxial delgado	185 m
10base5	10	Coaxial grueso	500 m
100base-TX	100	UTP categoría 5	100 m
Full Dúplex Ethernet	20	UTP categoría 3,4 ó 5 4 pares	100 m
Full Dúplex Fast Ethernet	200	UTP categoría 5, 4 pares	100 m
10base-F	10	Fibra óptica multimodo	2 Km.
Ethernet FOIRL	10	Fibra óptica unimodo	1 Km.

ATM Media

This chapter provides information for ATM Media Specifications.

ATM Media Specifications

Table A-1 shows the ATM Media Specifications for TAXI, OC3c Multimode Fiber, OC3c Single Mode Fiber (intermediate and long range), OC12c Multimode, OC12c Single Mode Fiber (intermediate and long range), STS3c, and DS3c physical interfaces.

Table A-1. ATM Media Specifications for Physical Interface

Physical Interface	Media Type	Data Rate	Connector Type	Typical Link Distance
TAXI	Multimode Fiber	100 Mbps	SC	2 kilometers
STS3c	Category 5 Unshielded Twisted Pair	155 Mbps	RJ45	100 meters
DS3	75 Ohm Coaxial Cable	45 Mbps	BNC	136 meters
OC3c	Multimode Fiber	155 Mbps	SC	2 kilometers
OC3c	Single Mode Fiber Intermediate Range	155 Mbps	SC	25 kilometers
OC3c	Single Mode Fiber Long Range	155 Mbps	SC	50 kilometers
OC12c	Multimode	622 Mbps	SC	500 meters
OC12c	Single Mode Intermediate Range	622 Mbps	SC	25 kilometers
OC12c	Single Mode Long Range	622 Mbps	SC or FC	50 kilometers

FDDI SPECIFICATIONS

This appendix outlines FDDI specifications and design considerations.

Table B-1. General Rules and Specifications

Max. Number of Connections	1000 (500 stations) Stations are connected in series on an optical fiber ring. Since fiber optics is a point to point media, no taps are allowed between stations.
Data Rate	100 Megabits per second
Max. Total Ring Length	100km (or 200 km in wrap state)
Drive Length (Max. Distance between Stations)	-Multimode Fiber: 2 km (1.2 Miles) -Single Mode Fiber: 60 Km (36 Miles) -Category 5 Shielded Twisted Pair cable: 100 Meters (328 Feet) -Category 5 Unshielded Twisted Pair cable: 100 Meters (328 Feet)
Transmission Media: Fiber Optics	Multimode Fiber (MMF-PMD) as defined by ANSI X3.166-1990. Single Mode Fiber (SMF-PMD) as defined by ANSI X3.184-1993.
Proposed Twisted Pair	Unshielded Twisted Pair (UTP) Shielded Twisted Pair (STP)
Link Budget	≤ 11dB

TOKEN RING NETWORK CABLING

This chapter provides an overview of the different cable types used for Token Ring networks. It covers basic cabling terminology and also performance and design specifications for shielded twisted pair (STP), unshielded twisted pair (UTP), and fiber optic cable types as specified by the ANSI/TIA/EIA-568-A standard. Figure 4-1 illustrates how different cable types can be used in a Token Ring network installation composed of Cabletron Systems Token Ring network products.

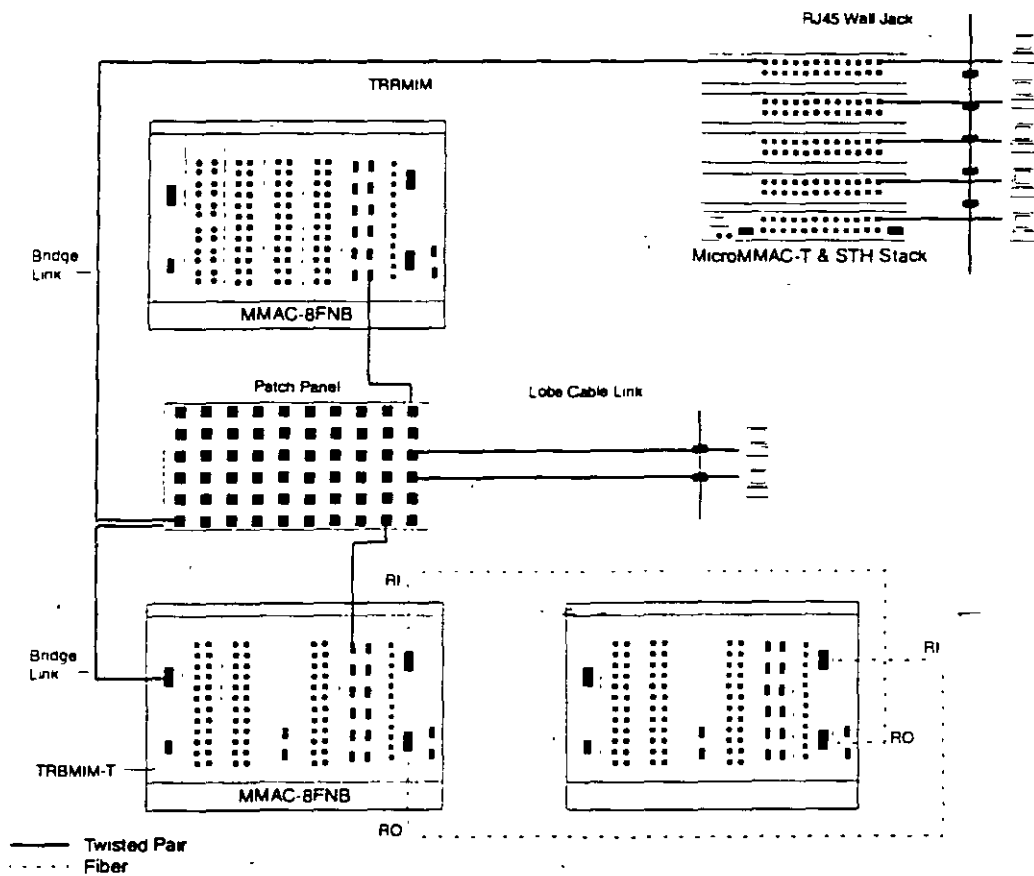

Figure 4-1. Example Mixed-Media Installation Configuration

STP CABLE SPECIFICATIONS

The following is a summary of cable specifications that apply to STP cabling used with Cabletron Systems Token Ring products. Product changes could produce differences between this summary and the individual product specifications. Always refer to the specific product installation guide for current specifications.

Cabletron Systems Token Ring products support IBM Type 1, 2, 6 and 9 shielded twisted pair (STP) cable, which are described as follows:

- **Type 1** consists of two shielded twisted pairs (STP) of 22 American Wire Gauge (AWG) solid wire for data. It is typically used for the longest cable runs within the walls of buildings.
- **Type 2** is similar to Type 1 data cable, but has four additional unshielded twisted pairs of 22 AWG solid wire carried outside of the shield casing. It is typically used for voice communication.
- **Type 6** consists of two STP of 26 AWG stranded wire for data. Type 6 is used in patch panels or to connect devices to/from wall jacks.
- **Type 9** is similar to Type 1, but uses 26 AWG solid wire.

STP Construction

An STP cable has a braided metallic shielded enveloping two twisted pairs of copper wire. The purpose of the shield is to protect data traffic on the wire from intrusive and unwanted electrical interference from outside sources. The shield must be grounded at both ends of the connection. Figure 4-2 illustrates STP components.



Figure 4-2. Shielded Twisted Pair Cable

Recommended Maximum Cable Lengths and Stations

Table 4-1 lists recommended trunk (RI/RO) and lobe lengths for STP cable types 1 and 2 used with active and passive Cabletron Systems products at 4 and 16 Mbps. It also lists maximum stations supported.

Table 4-1: Recommended Maximum Cable Lengths And Station

	STP Type 1/2
RI/RO Distance, 4 Mbps	770 m
RI/RO Distance, 16 Mbps	346 m
Active Device, 16 Mbps	
Maximum Stations	250
Maximum Lobe Length	150 m
Passive Device, 16 Mbps	
Maximum Stations	250
Maximum Lobe Length	100 m
Active Device, 4 Mbps	
Maximum Stations	250
Maximum Lobe Length	300 m
Passive Device, 4 Mbps	
Maximum Stations	250
Maximum Lobe Length	200 m

Attenuation

Maximum attenuation for specific cable types at 4 and 16 megahertz is shown by Table 4-2. The attenuation values include the attenuation of the cables, connectors, and patch panels.

Table 4-2: Maximum Cable Attenuation

	4.0 Mhz	16.0 Mhz
STP (IBM Types 1 & 2)	22 dB/km	45 dB/km
STP (IBM Types 6 & 9)	33 dB/km	66 dB/km

Recommended Maximum Cable Lengths and Stations

Table 4-3 lists recommended trunk (RI/RO) and lobe lengths for UTP cable types used with active and passive Cabletron Systems products at 4 and 16 Mbps. It also lists maximum station supported.

Table 4-3. Recommended Maximum Cable Lengths and Stations

	UTP Cat. 3/4	UTP Cat. 5
RI/RO Distance, 4 Mbps	200 m	250 m
RI/RO Distance, 16 Mbps	100 m	120 m
Active Device, 16 Mbps		
Maximum Stations	150	150
Maximum Lobe Length	100 m	120 m
Passive Device, 16 Mbps		
Maximum Stations	100	100
Maximum Lobe Length	60 m	85 m
Active Device, 4 Mbps		
Maximum Stations	150	150
Maximum Lobe Length	200 m	250 m
Passive Device, 4 Mbps		
Maximum Stations	100	100
Maximum Lobe Length	100 m	130 m

FIBER OPTIC CABLE SPECIFICATIONS

Fiber optic cable is a high-performance media used for both baseband and broadband transmission. It provides far greater bandwidth and greater transmission rates than twisted-pair copper cable and lower attenuation as well. Fiber optic cable is immune to Electromagnetic Interference (EMI) and Radio-Frequency Interference (RFI) and does not radiate EMI.

Data bits are represented by optical signals, which are generated by and transmitted over fiber optic cable by an LED or laser.

Multimode

There are two types of multimode fiber optic cable: step index and graded index. Both types are typically used for short-distance communications, shorter distances than are possible with single-mode fiber optic cable, that is. Step index fibers have an abrupt change in the index of refraction going from the core into the cladding, whereas graded index fibers have an index of refraction that decreases gradually going from the core to the cladding.

Recommended Maximum Cable Lengths and Stations

Table 4-3 lists recommended trunk (RI/RO) and lobe lengths for fiber optic cable types used with active Cabletron Systems products at 4 and 16 Mbps. It also lists maximum stations supported.

Table 4-4. Recommended Maximum Cable Lengths and Stations

	Single-Mode	Multimode
RI/RO Distance, 4 Mbps	10 km	2 km
RI/RO Distance, 16 Mbps	10 km	2 km
Active Device, 16 Mbps		
Maximum Stations	250	250
Maximum Lobe Length	10 km	2 km
Active Device, 4 Mbps		
Maximum Stations	250	250
Maximum Lobe Length	10 km	2 km

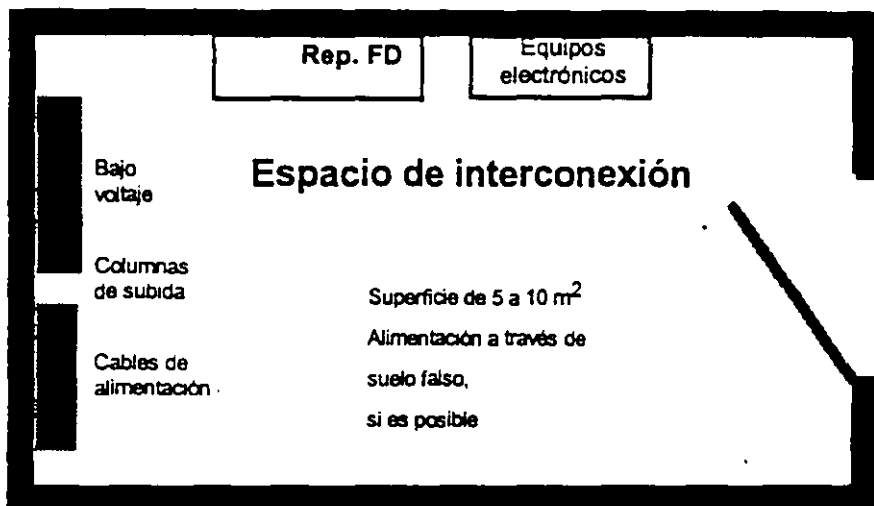
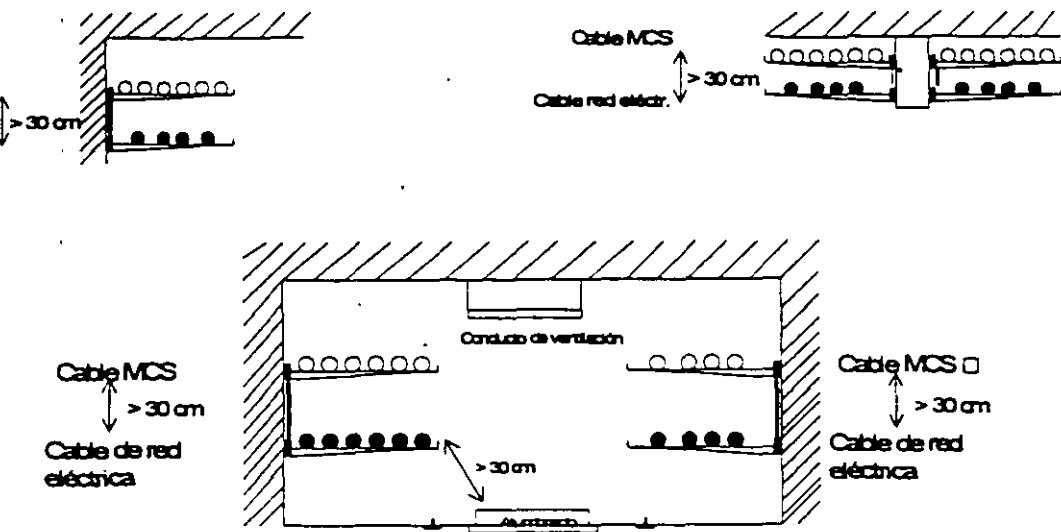

Ejemplo de disposición de un local de distribución

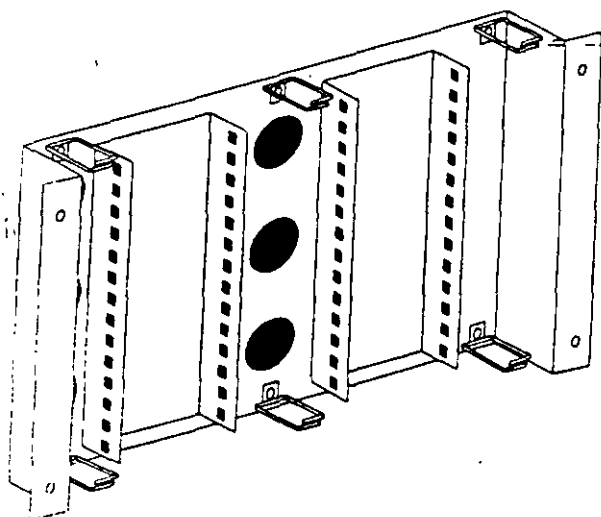

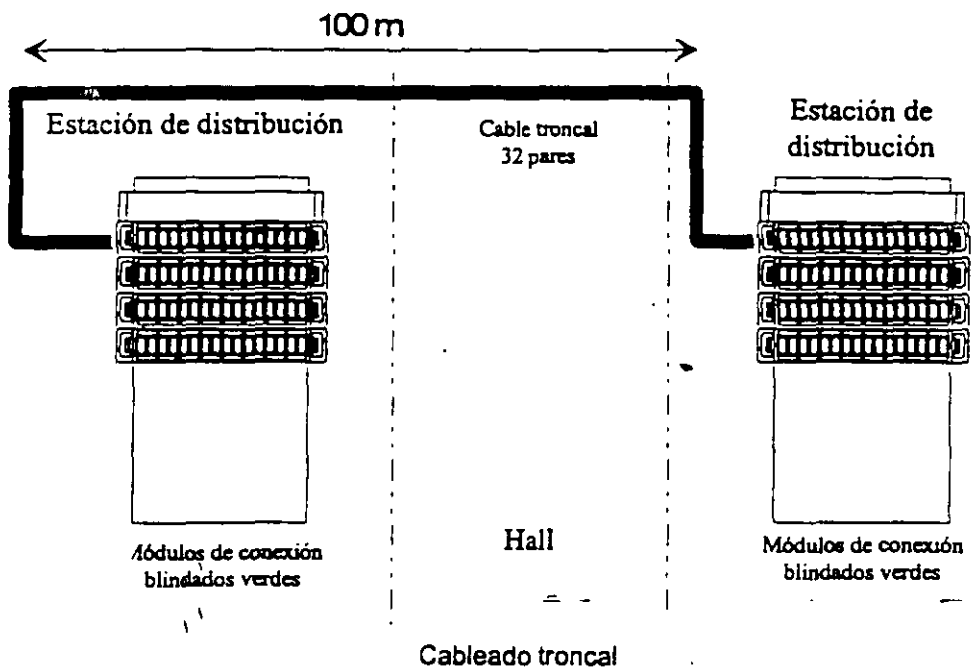
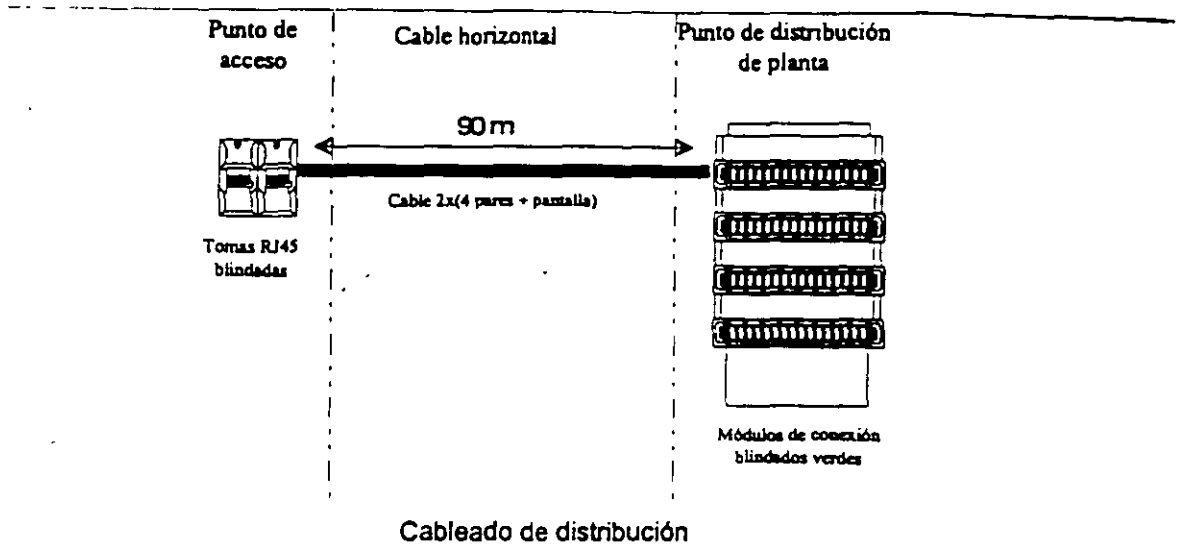

CABLEADO ESTRUCTURADO (INGENIERIA Y CERTIFICACION)

Tabla práctica para calcular la cantidad de cables que caben dentro de distintos diámetros de ductería			
ϕ pulg	ϕ mm	Cables de 4 pares	Cables de 32 pares
1/2	12	0	0
3/4	19	4	0
1	25	6	0
1 1/4	31	10	1
1 1/2	38	16	1
2	50	21	1
2 1/2	63	34	2.3
3	76	50	3
3 1/2	88	-----	5
4	101	-----	7

a) Considera longitudes minimas de 10 y maximas de 30 metros entre registros.
 b) Concidera como máximo una suma de dobleces de 180° a lo largo de la trayectona
 c) Concidera registros adecuados en los extremos (no condulets)

CURSO DE CABLEADO ESTRUCTURADO

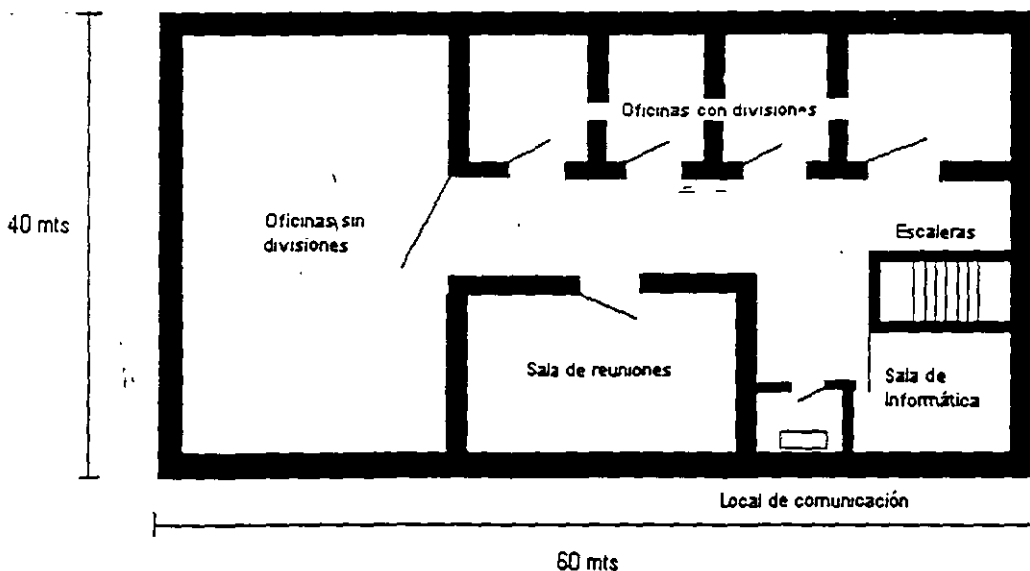

Distribución Interna del edificio

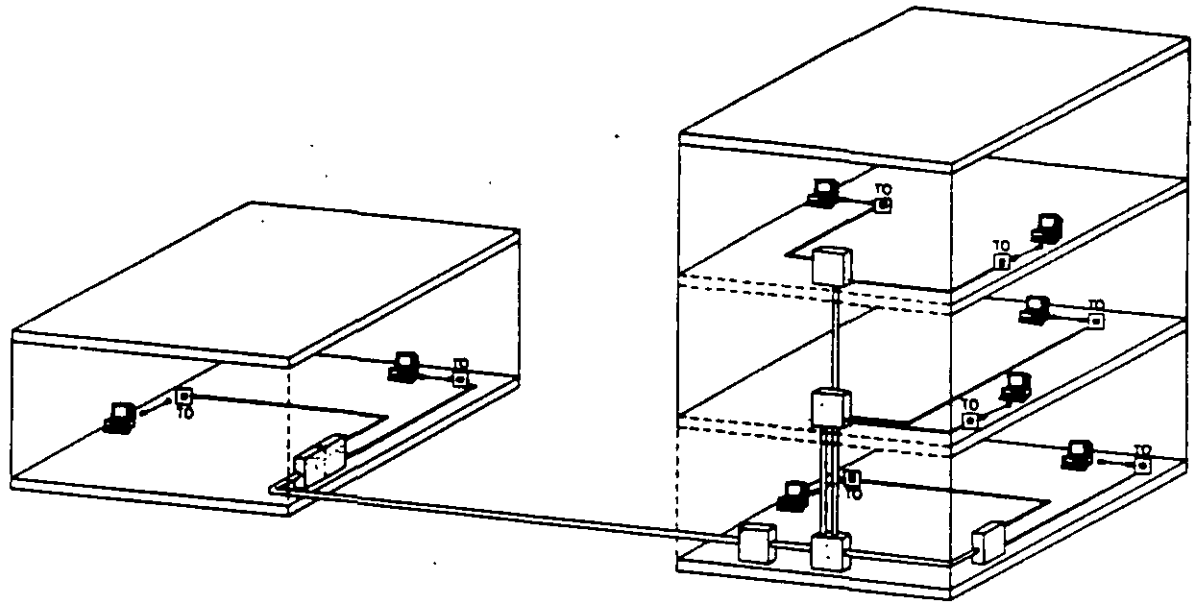

SISTEMA DE CABLEADO GENERAL

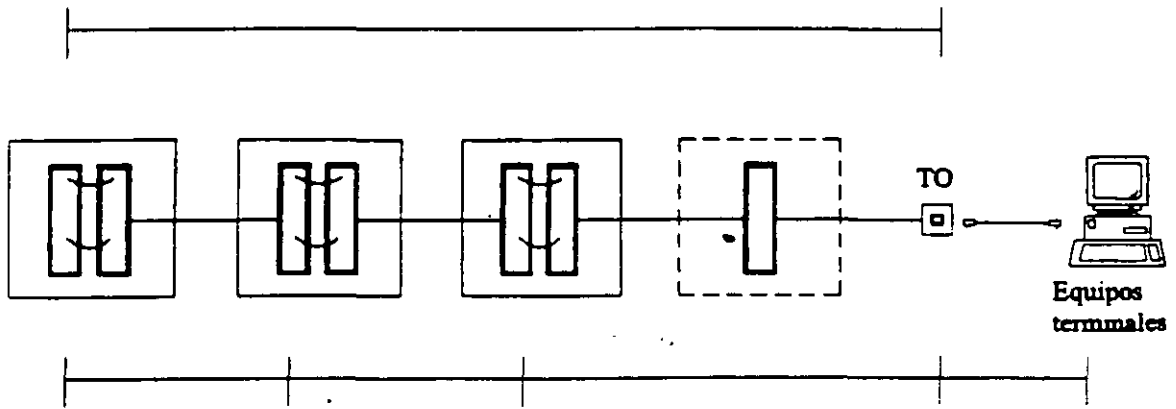



DIPLOMADO EN REDES DE
COMPUTADORAS (LAN, WANY GAN)

CABLEADO ESTRUCTURADO
(INGENIERIA Y CERTIFICACION)

Analisis del Mercado

[Home Page](#)

BELDEN OUTDOOR OPTICAL FIBRE CABLES



Applications

Belden outdoor optical fibre cables are suitable for application in both digital and analog optical transmission systems.

The optical characteristics of the cabled fibres are compliant with current (inter)national specifications such as those set by FDDI, EIA, IEEE, CCITT, IEC, UL and VDE as well as the generally accepted specifications of companies such as IBM, DEC, Dutch PTT, DBP Telekom, AT&T and France Telecom.

All cable types are watertight, provided with a UV-resistant polyethylene (PE) outer sheath and designed for external installation in tubes, ducts, tunnels, trenches and for direct burial.

Although all cables are developed for outdoor applications, they are, in principle, also suitable for indoor installations.

Range of Cables

Non-metallic (metal-free) optical fibre cables, constructed in compliance with various (inter)national and industrial standards. This range includes cable with a maximum of 18 - 48 - 72 and 144 fibres. These cables contain no metallic elements which might conduct electricity, and are therefore immune to electrical interference (lightning), spark-free and therefore safe (from explosion) and ideal for a perfect galvanic separation.

Metallic optical fibre cables, constructed to various national PTT specifications. This range includes cables with a maximum of 12 - 36 - 72 and 132 fibres.

Miniature optical fibre cables, with a maximum of 12 fibres.

Aerial outdoor optical fibre cables, both metallic and non-metallic, with a maximum span of 50 meter's.

Special Options

Halogen-free (FRNC/LSOH) cables for in- and outdoor application between and inside buildings.

Thanks to its long-term experience and know-how in cables and the flexibility of its organization and equipment Belden can supply optical fibre cables which are 'custom made to your requirements'.

Belden has carried out an extensive program to learn what parameters influence the process of blowing cables into tubes and to what extent they do so. As a result Belden can supply cables with improved 'blow into tube' performance. Moreover, Belden can provide support in order to determine a practical optimum in the combination of cable, tube and blowing technology.

OPTICAL FIBRES

Construction

General Specifications: IEC-793 and CCITT G.652.

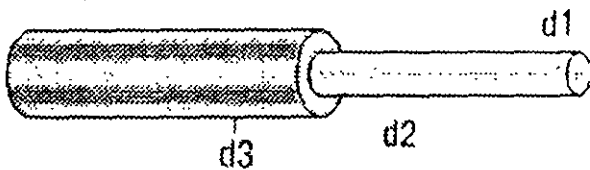

d1 - Mode field diameter or light conducting core of quartz glass with dopes: for Ø see table.

d2 - Optical cladding of quartz glass: $\text{Ø}125 \pm 2\mu\text{m}$

d3 - Primary acrylate coating, which is easy to strip: $\text{Ø} 250 \pm 15 \mu\text{m}$.

OPTICAL CHARACTERISTICS

Single-Mode-Matched Cladded

Optical Fibres

Standards	d1 μm	Wavelength nm	Attenuation db/km	Dispersion ps/nm*km	W
CCITT	9.3	1310	<0.38	<3.5	
IEC-793-1	± 0.5	1550	<0.25	<18	

Optical fibre with other specifications are available on request

MULTI-MODE OPTICAL FIBRES

Standards	d1 (μm)	Wavelength (nm)	Attenuation (db / km)	Bandwidth (Mhz * km)
IEC-793	62.5	850	< 3.2	> 200
FDDI	± 3	1300	< 0.9	> 500
ESCON	62.5	850	< 3.2	> 200
	± 3	1300	< 0.9	> 800
VDE				
IEC-793	50	850	< 2.7	> 400
CCITT	± 3	1300	< 0.8	> 1000
G. 651				

Optical fibre with other specifications are available on request

SECONDARY COATING

LOOSE TUBE, filled with jelly.

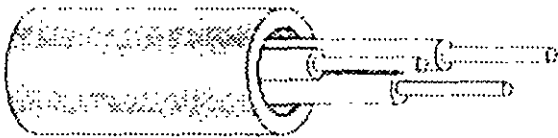
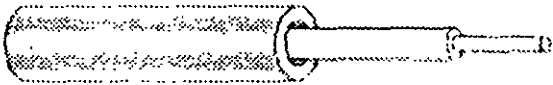

Constructed in accordance with IEC-794.

From 1 to 12 optical fibres, encapsulated within a plastic tube filled with silicon-free waterproof jelly.

Colour coding of the loose tubes with

- MM 50/125 : green - MM 62.5/125 : blue - SM 9-10/125 : yellow

Outer diameter up to and including 3 optical fibres: $\text{Ø } 1.5 \pm 0.10 \text{ mm}$

Outer diameter up to and including 8 optical fibres: $\text{Ø } 2.1 \pm 0.15 \text{ mm}$

Outer diameter up to and including 12 optical fibres: $\text{Ø } 2.6 \pm 0.20 \text{ mm}$

Outer diameter up to and including 12 optical fibres: $\text{Ø } 3.0 \pm 0.20 \text{ mm}$ (only in miniature cables).

Optical fibres in one loose tube are differentiated according to the following colour codes: natural (fibre 1) - red (2) - blue (3) - yellow (4) - green (5) - violet (6) - brown (7) - black (8) - orange (9) - turquoise (10) - pink (11) and white (12).

Other colour codes are available on request.

MINIATURE OPTICAL FIBRE CABLES

With up to 12 optical fibres, with or without an aluminum foil as an extra moisture barrier:

Special Features

These are extremely light and thin optical fibre cables with a high maximum tensile strength of 4 * its own weight for a 1 km length.

They are suitable for simultaneous - three at a time - installation into HOPE tubes by means of compressed air or pulling wire.

Although developed for applications between buildings and/or installations, this type of optical fibre cable is also suitable for indoor applications.

Applications

Temperature range

- Transport/storage : -30 to 70°C
- Installation : -10 to 50°C
- Operation : -30 to 70°C

Bending radius

- Installation : >15 * cable diameter
- Operation : >20 * cable diameter.

Cable Specifications

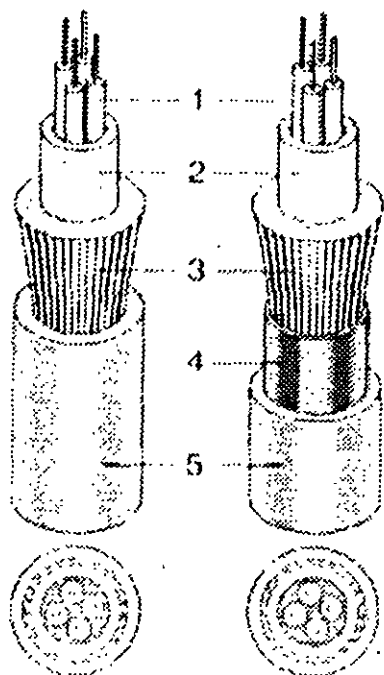

1 Primary coated multi-mode and/or single-mode optical fibres: $\text{Ø } 250 \pm 15 \mu\text{m}$.

2 Jelly filled loose tube, with up to 12 fibres: $\text{Ø } 3.0 \pm 0.20 \text{ mm}$.

Individually colour coded optical fibres: natural -red -blue -yellow -green -

violet -brown -black -orange -turquoise - pink and white.

Colour coding of the loose tube with:

MM 50/125 : green - MM 62.5/125 : blue - SM 9/125 : yellow.

3 Aramid yarns as strength members.

Swelling yarns for longitudinal watertightness.

5 Black UV-resistant PE outer sheath (other colours available on request).

Identification: BELDEN OPTICAL CABLE 'number * type of fibres' and metre-marking.

Number of fibres	Cable diameter Ø (mm)	Max. pulling tension; installation/operation (N)	Weight PE	Weight PVC
1-12	5.6 ± 0.3	1000/200	23	27

Options:

Cable comprising two, three or four miniature cables with a common outer sheath.

Aluminum foil (4) beneath the PE outer sheath (delivery length < 1000m).



The Communications Web Sites

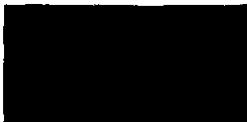

[HOME](#) | [SITE MAP](#) | [ADD YOUR COMPANY](#) | [MEET THE PUBLISHER](#)
Broadband guide | [DIRECTORIES](#) | [NEWSLETTERS](#) | [WHITE PAPERS](#)
[CATALOG SHOWCASE](#) | [ON-LINE FORUMS](#)
[ASK THE EXPERT!](#) | [PRODUCT SHOWCASE](#) | [LIVE EVENTS!](#) | [SEARCH](#)

Krone, Inc.

6950 South Tucson Way
 Suite R
 Englewood, CO 80112
 USA

(303) 790-2619 (voice)
 (303) 790-2117 (fax)

Krone supplies telecommunications wire and cable connecting hardware including IDC wire termination blocks, patch panels and station outlets.

[Request Information](#)

[Online Forums](#) | [Newsletters, White Papers](#) | [Catalog Showcase](#) | [Directories](#) |
[Home](#) | [Search](#) | [LiveEvents!](#) | [Product Showcase](#) | [Ask the Expert!](#) |
[Sponsors, Advertisers](#) | [Categories](#) | [Contractors](#) | [Company Index](#) |
[Meet the Publisher](#) | [Add Your Company](#) | [Site Map](#) | [Home](#)

The Communications Web Sites

Broadband guide | **Contractors DIRECTORY** | **LiveEvents!** | **LIGHTWAVE Xtra!**
WIRELESS INTEGRATION Xtra! | **OSP Xtra!** | **Cabling Xtra!**

[Broadband Guide](#) | [Contractors Directory](#) | [LiveEvents!](#) |
[LIGHTWAVE Xtra!](#) | [Wireless Integration Xtra!](#) |
[OSP Engineering & Construction Xtra!](#) |
[Cabling Installation & Maintenance Xtra!](#)

 Visit the Optoelectronics Web Sites
 Meet the Publisher

Comments or Questions about this site, please contact the Webmaster.

©Copyright 1995-1998 PennWell Media Online
 This page was updated on 12-Jan-99



PRODUCTS INDUSTRIES CATALOG ABOUT AMP SUPPORT HOME

Telco/CATV Products & Services Fiber Optic

- [ABOUT AMP](#)
- [Distributors](#)
- [Employment](#)
- [Feedback](#)
- [Financial](#)
- [Global AMP](#)
- [News Releases](#)
- [Technology](#)

- [INDUSTRIES](#)
- [Automotive](#)
- [Communication](#)
- [Networking](#)
- [PC](#)
- [Power Tech](#)
- [TELCO/CATV](#)

- [SOLUTIONS](#)
- [M/A-COM](#)
- [Carroll Touch](#)
- [Precision](#)
- [Interconnect](#)

CABLE MANAGEMENT SYSTEMS

AMP provides a range of fiber management solutions — including rack-mount systems and patch panel and splice enclosures — for the central office, headend, and central wiring closets. Our newest offering, a 72-port enclosure for fiber optic cable patching and housing of splitter modules, is designed for managing high fiber density and for easy access and installation. Choose from basic enclosures, models pre-loaded with adapter plates, and a variety of pre-stubbed units with cable assemblies made to your specifications.



For more detailed information on AMP Cable Management Systems, see the NETCONNECT / Fiber Optic Distribution Products section of

[AMP Connect](#), our on-line electronic catalog. Or [contact us](#).

- [Cable Management Systems](#)
- [Connectors & Cable Assemblies](#)
- [Splices](#)
- [Attenuators](#)
- [Couplers, Splitters & Modules](#)
- [Wavelength Division Multiplexers \(WDMs\)](#)
- [Innerduct Products](#)

AMP.COM SITE MAP

[Products](#) | [Industries](#) | [Catalog](#) | [About AMP](#) | [Support](#) | [Home](#)

AMP

PRODUCTS INDUSTRIES CATALOG ABOUT AMP SUPPORT HOME

Telco/CATV

Products & Services

Fiber Optic

CONNECTORS & CABLE ASSEMBLIES

AMP offers a wide selection of fiber connectors in industry-standard styles, ready for easy termination or as part of basic and custom cable assemblies. In line with Bellcore GR-326, Issue 2, AMP offers systems at tiered levels of performance, from 50 dB to 65 dB, to help meet your application and cost requirements. The endface geometry of AMP cable assemblies is in keeping with the IEC proposal for long-term system expandability and reliability. AMP Service Cable Assemblies, used to branch from a splice closure on a fiber right-of-way to an active fiber termination point, are available in a range of connector types and cable lengths.

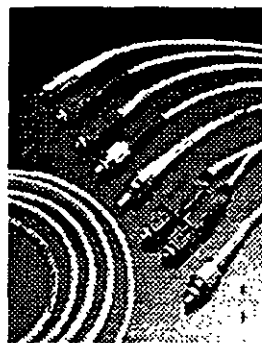

Cable Management Systems

Connectors & Cable Assemblies

Splices

Attenuators

Couplers, Splitters & Modules

Wavelength Division Multiplexers (WDMs)

Innerduct Products

AMP.COM SITE MAP

For more detailed information on these products, see the Fiber Optic Products section of AMP Connect, our on-line electronic catalog.

Or contact us.

Products | Industries | Catalog | About AMP | Support | Home



PRODUCTS INDUSTRIES CATALOG ABOUT AMP SUPPORT HOME

TELCO/CATV

Products & Services

Fiber Optic

INNERDUCT PRODUCTS

- [ABOUT AMP](#)
- [Distributors](#)
- [Employment](#)
- [Feedback](#)
- [Financial](#)
- [Global AMP](#)
- [News Releases](#)
- [Technology](#)
- [SERVICES](#)
- [Automotive](#)
- [Communication](#)
- [Networking](#)
- [PC](#)
- [Power Tech](#)
- [TELCO/CATV](#)
- [TELEVISION](#)
- [MEA-COM](#)
- [Carroll Touch](#)
- [Precision](#)
- [Interconnect](#)

OptiDuct liners make maximum use of conduit capacity. Available in various sizes, configurations, and lengths, they feature proven durability to eliminate cracking and unitized construction to minimize spiraling. A coupling joins sections in an air-tight splice to allow cables to be easily blown, pushed, or pulled through the innerduct.



For more detailed information on these products, [contact us](#).

- [Cable Management Systems](#)
- [Connectors & Cable Assemblies](#)
- [Splices](#)
- [Attenuators](#)
- [Couplers, Splitters & Modules](#)
- [Wavelength Division Multiplexers \(WDMs\)](#)
- [Innerduct Products](#)

AMP.COM SITE MAP

[Products](#) | [Industries](#) | [Catalog](#) | [About AMP](#) | [Support](#) | [Home](#)

**1995
LUCENT TECHNOLOGIES***

Revenues _____ **\$21 billion**
Assets _____ **\$20 billion**
Employees _____ **131,000**

**Revenues, assets and employees represent those the company would have shown at year-end had it existed as a separate company (see the Financial Review section for more details). The number of employees listed does not reflect the total impact of previously announced work force reductions.*

Bell Laboratories, widely regarded as one of the world's foremost industrial research and development organizations.

Among its achievements since its inception in 1925: an average of one patent each business day, seven Nobel Prize winners, seven U.S. National Medals of Science and five National Medals of Technology. Its contributions include the transistor, the solar cell, the communications satellite, cellular telephony, electronic switching and the UNIX[†] operating system.

[†]Unix is a registered trademark licensed exclusively by Novell, Inc.

A global presence.

Lucent Technologies has offices or distributors in more than 90 countries or territories. Bell Labs has a presence in 13 countries.

More than a hundred years of manufacturing experience.

During the past five years, our manufacturing practices have earned a Malcolm Baldrige National Quality Award, a Deming Prize and two Shingo Prizes for excellence in American manufacturing.

Lucent Technologies
Bell Labs Innovations



Our name was developed after extensive interviews with customers and other stakeholders. Lucent means "marked by clarity" or "glowing with light." The new logo is a bold, red, hand-drawn innovation ring.

☒ Supplies network telecommunications systems, software and services to telephone companies around the world, the U.S. government, private communications network operators, cable companies and wireless service providers.

☒ Produces high-performance integrated circuits, power systems and optoelectronic components for Lucent Technologies and other leading communications and computer manufacturers. During the last five years, sales to non-AT&T customers have shown double-digit growth rates.

☒ Designs, manufactures, installs and services business telecommunications systems, including private branch exchanges, key systems, structured cabling and voice processing systems. Has provided engineering, installation, maintenance and support services to more than 1.5 million customer locations in more than 90 countries.

☒ Sells, services and leases telephones and other telecommunications devices through retailers representing 17,000 point-of-sale locations. Was the first in the industry to offer cordless telephones with 25-channel capability, which reduces interference. Sold 2.5 million Trimline® telephones in 1995. Offers a broad line of telephone answering systems and cellular products.

☒ Focuses on several core technologies: software, digital signal processing, telecommunications networking technologies, microelectronics and photonics. Emphasizes areas offering Lucent Technologies' operating units a competitive advantage, such as increased transmission capacity, faster call processing, increased reliability and reduced network costs.



Note: Rank orders listed refer to market share.

<p>This gaucho in Argentina's remote ranch lands now has access to telephone service, thanks to a wireless network that Network Systems played a key role in building.</p>	<ul style="list-style-type: none"> ■ Ranks #1 in U.S. public network infrastructure market, #2 worldwide. Flagship product, the 5ESS® 2000 Switch, has been installed in 49 countries and can provide any media—digital voice, data, video and wireless communications. According to data compiled in the U.S. Federal Communications Commission's Armis Report, it is the most reliable switch in the industry.
<p>Microchips are the very heart of information age products and systems, and we offer a wide variety of standard, semi-custom and custom products.</p>	<ul style="list-style-type: none"> ■ At year-end 1995 the unit's microelectronics products were included in more than half the world's digital cellular phones. Has a research, design, manufacturing or sales presence in 15 countries to enable close design collaboration with customers.
<p>Definity® Enterprise Communications Server phones for businesses, redesigned for European technical standards and aesthetics, roll off the manufacturing line in Saumur, France.</p>	<ul style="list-style-type: none"> ■ Offers a broad line of systems and products that can be integrated into a business's network and upgraded with new software releases. Intelligent diagnostic software built into systems and service centers around the world reduces system downtime and provides a key competitive advantage.
<p>The Two-Line Personal Information Center 882 does double-duty as a phone and personal data organizer for home-based businesses.</p>	<ul style="list-style-type: none"> ■ For the nine months ended September 30, 1995, sold twice as many corded telephones, cordless telephones and telephone answering systems in the U.S. as any competitor in each category. Captured a 5 percent share of the market for cellular phones in the U.S. since entering the market in 1992 with innovations such as user-friendly, on-screen instructions, voice activation and circuitry that filters out background noise.
<p>In 1995 a Bell Labs research team devised a way to reliably transmit compressed color still images over wireless channels.</p>	<ul style="list-style-type: none"> ■ Integrated with Lucent Technologies' operating units to speed innovation. Focuses on technologies critical to telecommunications: software, digital signal processing, networking technologies, microelectronics and photonics.

Curso: Cableado Estructurado Ingeniería y Certificación

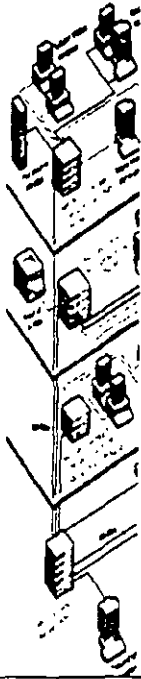

**DIPLOMADO EN REDES DE
COMPUTADORAS
(LAN, WAN y GAN)**

CABLEADO ESTRUCTURADO

CompuNet S.A. de C.V.
Tel. 4987726



Notas:

Curso: Cableado Estructurado Ingeniería y Certificación

SUBSISTEMAS DEL CABLEADO ESTRUCTURADO

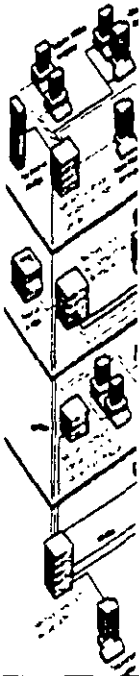

- - Subsistema Estación de Trabajo
- - Subsistema Horizontal
- - Subsistema Vertical
- - Subsistema de Administración
- - Subsistema de Cuarto de Equipo
- - Subsistema de Campus

Comunicaciones S.A. de C.V.
Tel. 4587724



Notas:

SUBSISTEMA ESTACIÓN DE TRABAJO

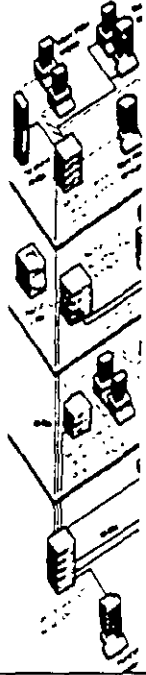

- Este subsistema contempla todos los adaptadores necesarios para conectar el equipo del usuario a la salida de información, logrando aquí la conexión física a cualquier teléfono, computadora o terminal de la red de cableado.

CompuServo Internet S.A. de C.V.
Tel. 6283726



Notas:

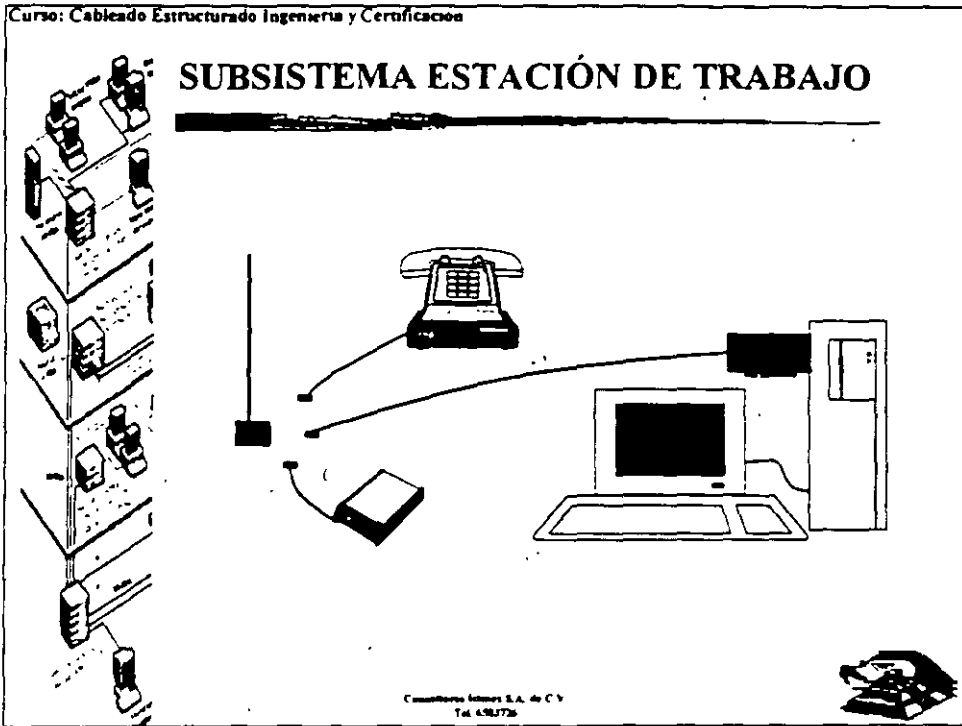

Notas:



Curso: Cableado Estructurado Ingeniería y Certificación

SUBSISTEMA ESTACIÓN DE TRABAJO

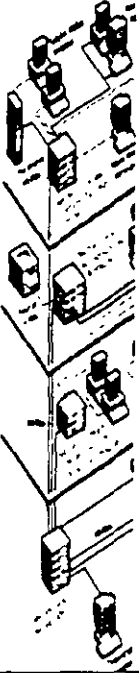

Coombars Jomari S.A. de C.V.
TA 45837a



Notas:

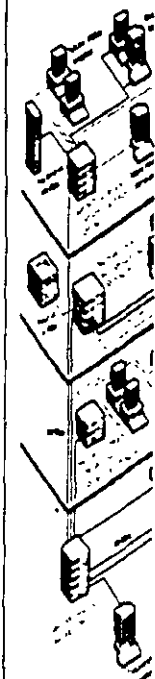

SUBSISTEMA HORIZONTAL

Aquí se contempla el cableado que corre de cada salida de información (roseta), al cuarto de alambrado de piso (IDF), se cuenta con diferentes cables y componentes para adecuarse a los requerimientos de los niveles de sistema, Esto es, se cuenta con cables de nivel 3 para sistemas telefónicos y/o de computo que transmitan a velocidades menores a 10 MBPS, y con cable nivel 5 para sistemas que requieren velocidades de comunicación de hasta 100 MBPS.

Compañía Latina S.A. de C.V.
Tel. 458726



Notas:

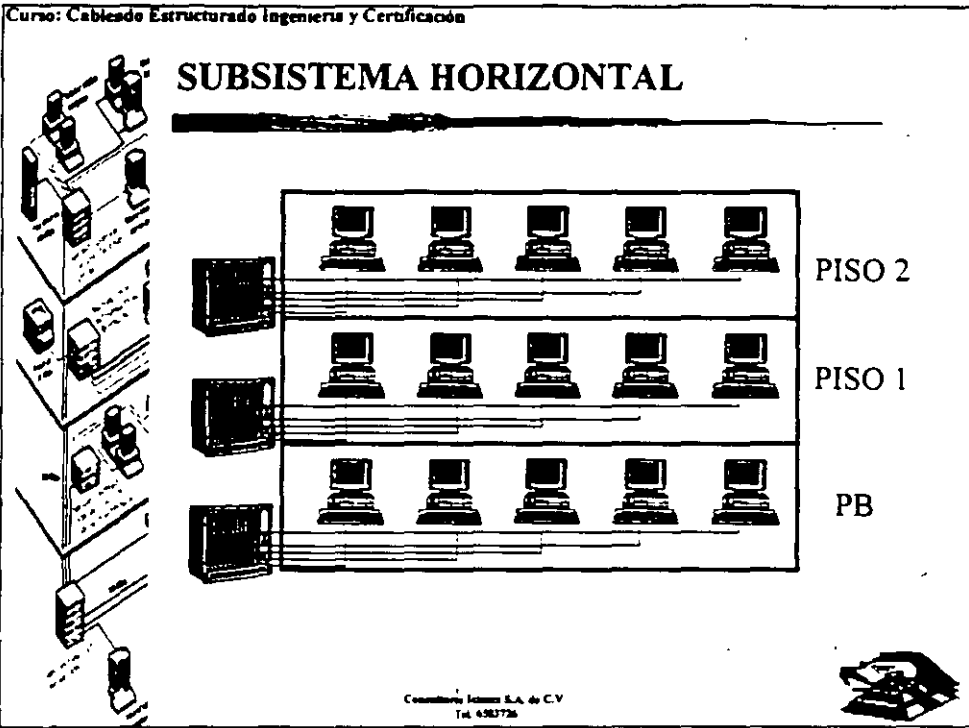

Notas:



Curso: Cableado Estructurado Ingeniería y Certificación

SUBSISTEMA HORIZONTAL

Consultores Icterus S.A. de C.V.
Tel. 6983726



Notas:

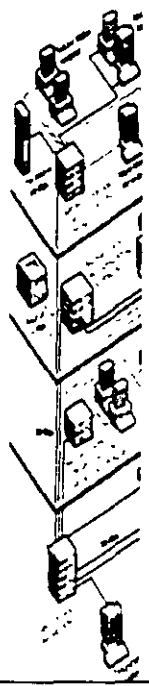

SUBSISTEMA VERTICAL

CONCEPTOS

- Este subsistema contempla la comunicación necesaria entre cada piso (IDF'S) y el distribuidor principal (MDF) Este enlace se logra mediante el uso de cable multipar o bien con Fibra Optica dependiendo de los requerimientos de velocidad que se tengan.

Comunicaciones S.A. de C.V.
Tel. 6583726



Notas:

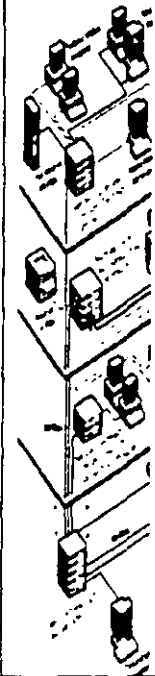

SUBSISTEMA VERTICAL

- CONCEPTOS
 - BACKBONE
 - BACKBONE COLAPSADO
 - BACKBONE LINEAL

Comunicaciones S.A. de C.V.
Tel. 6283776



Notas:

BACK BONE LINEAL

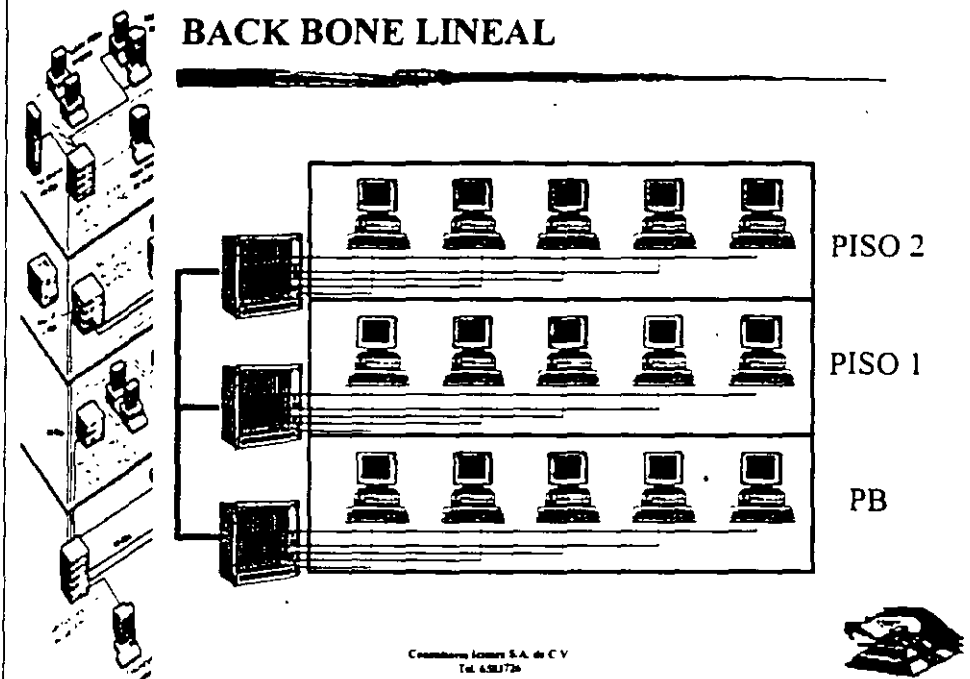

Notas:

BACKBONE COLAPSADO

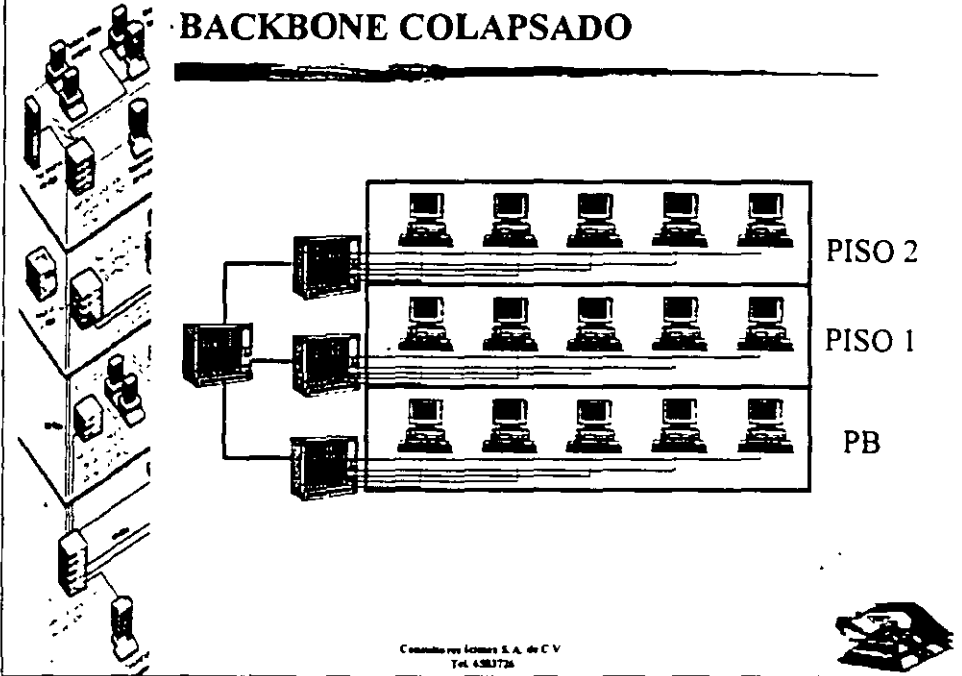

Notas:

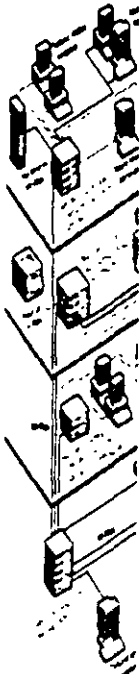

SUBSISTEMA DE ADMINISTRACIÓN

- Aquí convergen los subsistemas vertical y horizontal, siendo el lugar donde se logra la interconexión de ambos subsistemas. En el también radica una de las principales virtudes del sistema que es el etiquetado, cada uno de los sistemas quedan perfectamente identificados con un color característico, de manera que los cambios y movimientos que se soliciten, se podrán hacer en unos minutos, logrando así abatir importantemente los gastos de administración y mantenimiento de la red de comunicaciones.

Comodoro Ingenieros S.A. de C.V.
Tel. 498776



Notas:

SUBSISTEMA DE ADMINISTRACIÓN

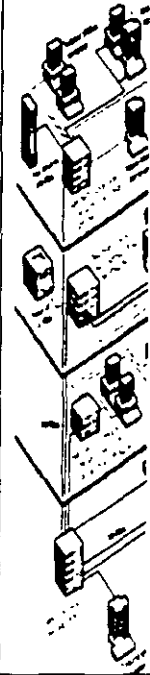

Subsistema Vertical

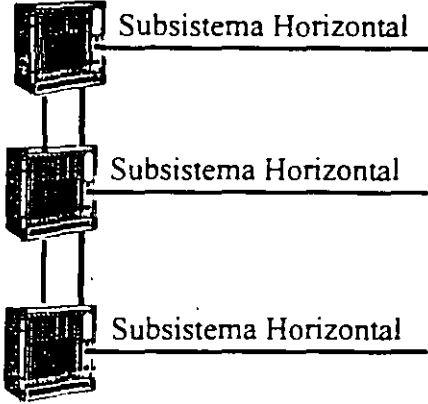

Comercial S.A. de C.V.
Tel. 4583726



Notas:

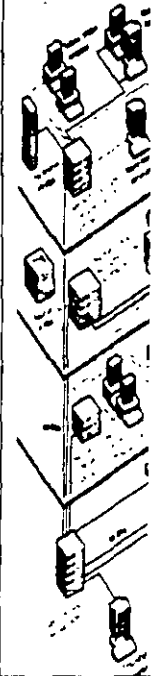

SUBSISTEMA DE CUARTO DE EQUIPO

- Este es el punto central de administración y control del sistema, donde se aloja normalmente el distribuidor principal del cableado estructurado con el PBX, el sistema central de proceso de datos (MAIN FRAME), y/o el punto neurálgico de administración de las redes locales (LAN), y distribuir las señales en toda la red, empleando la fibra óptica y el cable de par trenzado sin blindar UTP existentes en los otros subsistemas.

Comodoro Intero S.A. de C.V.
Tel. 4 92375



Notas:

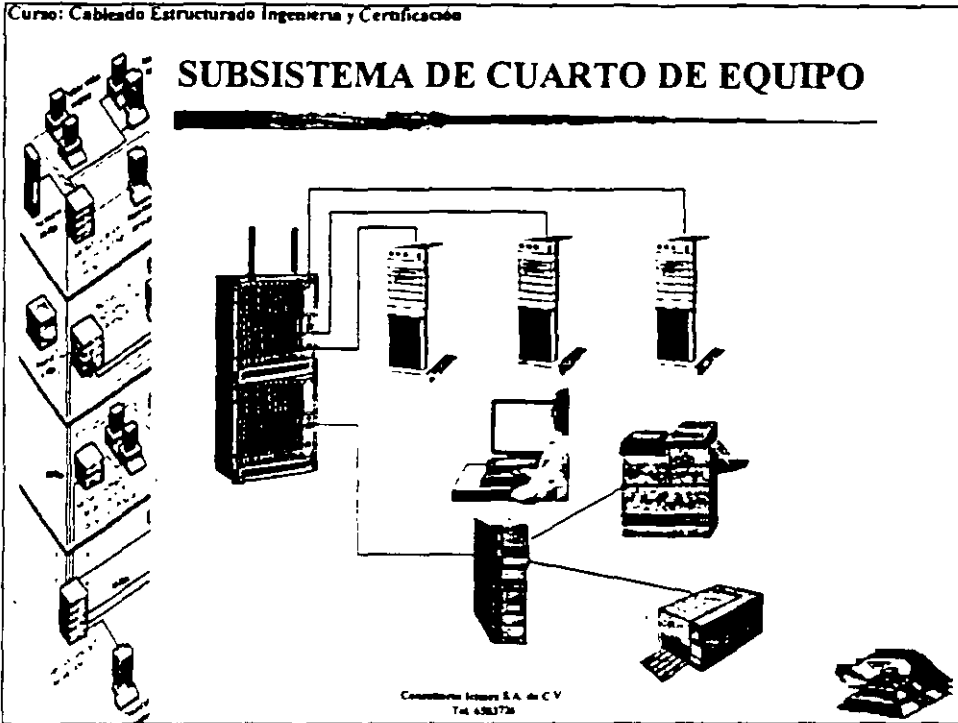

Notas:

SUBSISTEMA DE CAMPUS

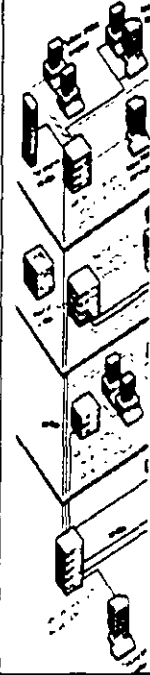

Este subsistema contempla la interconexión de diferentes edificios dentro de un mismo predio, empleando fibra óptica y/o cable multipar especialmente diseñado para instalarse en exteriores.

Consultores Icterus S.A. de C.V.
Tel. 6383726



Notas:

SUBSISTEMA DE CAMPUS

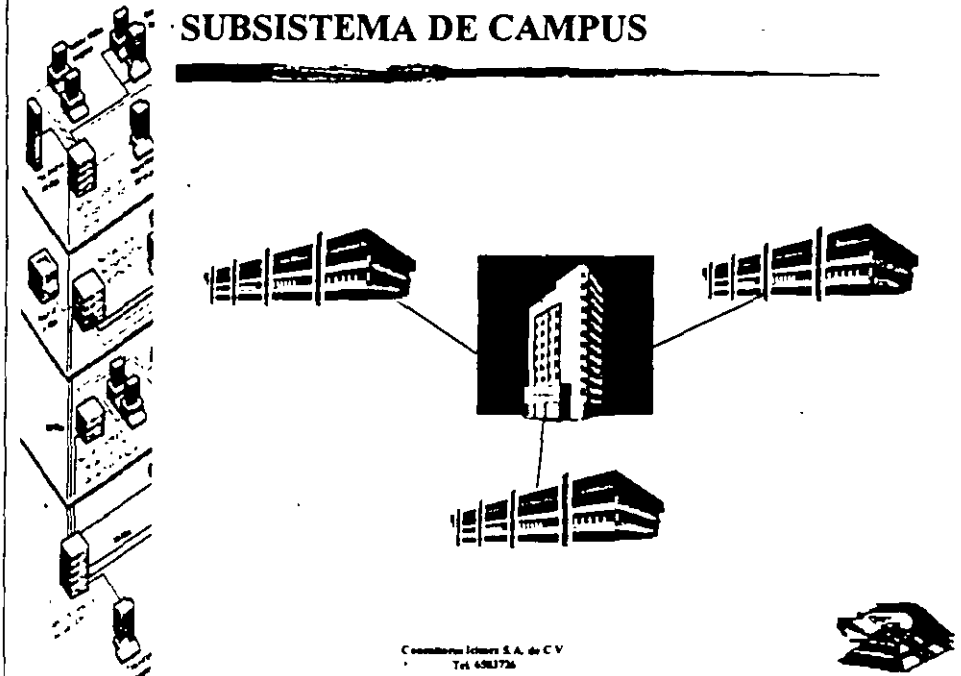

Notas:



Curso: Cableado Estructurado Ingeniería y Certificación

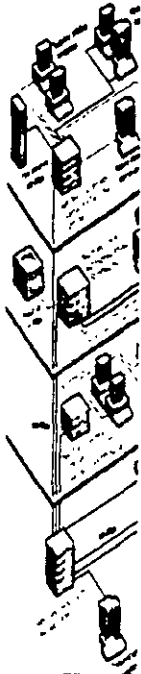

ESTÁNDARES Y NORMAS

- EIA/TIA 568a
- EIA/TIA 568b

Electronic Industries Association/Telecommunications Industry Association

Comunicaciones S.A. de C.V.
Tel. 4583776



Notas:

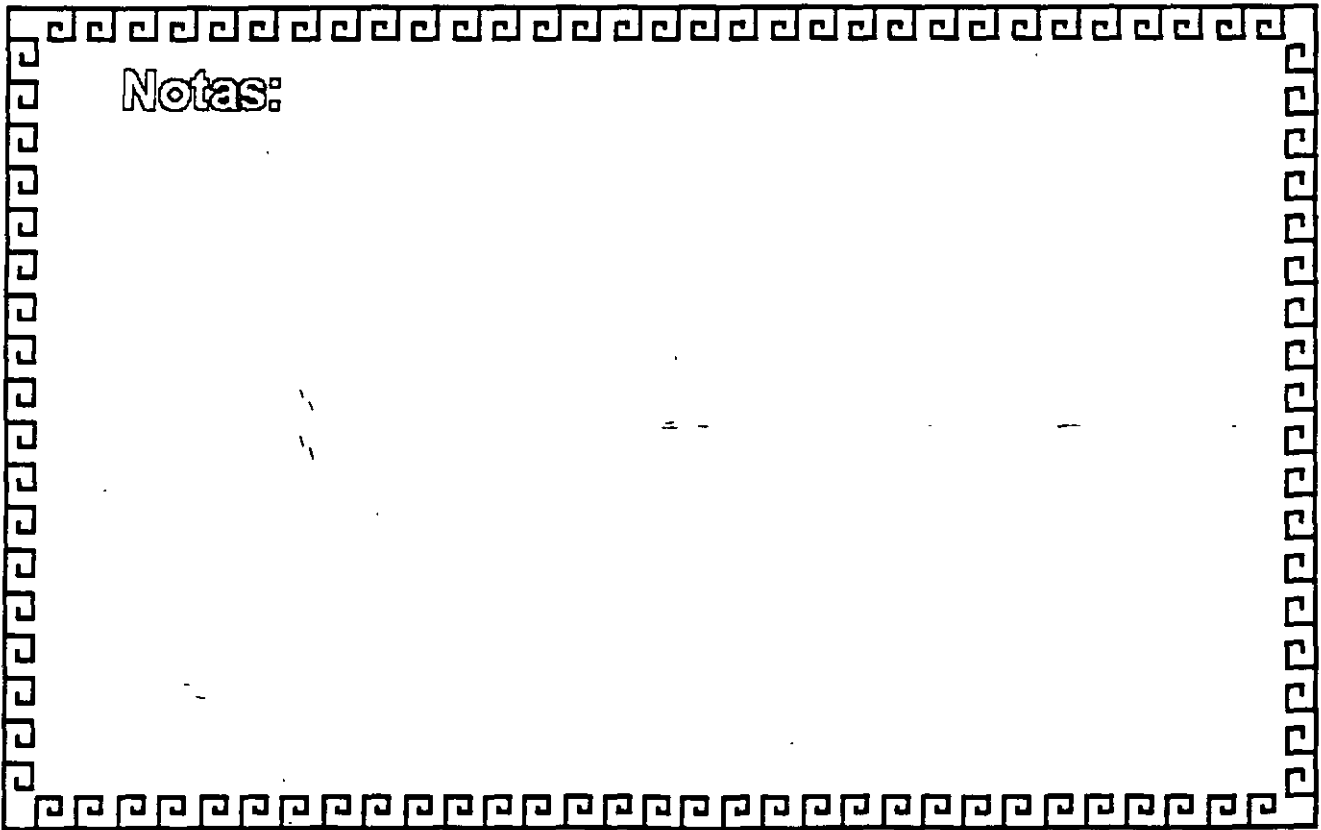

ESTÁNDARES Y NORMAS

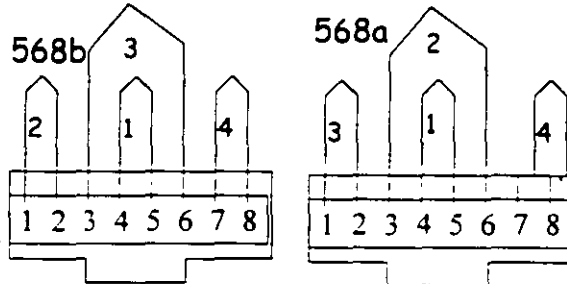
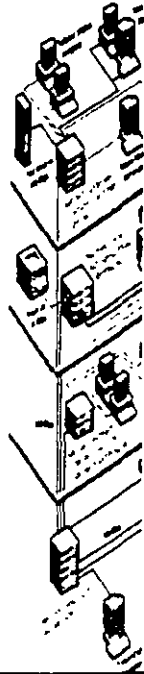

- 1 b/naranja
- 2 naranja
- 3 b/verde
- 4 azul
- 5 b/azul
- 6 verde
- 7 b/cafe
- 8 cafe

- 1 b/verde
- 2 verde
- 3 b/naranja
- 4 azul
- 5 b/azul
- 6 naranja
- 7 b/cafe
- 8 cafe

Comunicaciones S.A. de C.V.
Tel. 4383726



Notas:



DIPLOMADO EN REDES DE COMPUTADORAS (LAN, WAN y GAN)

CABLEADO ESTRUCTURADO

Compañía Inmers S.A. de C.V.
T.E. 482726





TIPOS DE CABLES

- AUI (ATTACHMENT UNIT INTERFACE)
- CABLE COAXIAL
- UTP (UNSHIELDED TWISTED PAIR)
- FIBRA OPTICA

Compañía Inmers S.A. de C.V.
T.E. 482726





TIPOS DE CONECTORES

- AUI
- DB15

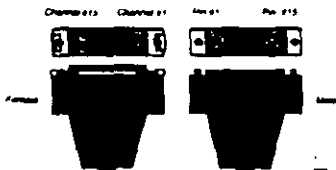

Compañía Inmers S.A. de C.V.
T.E. 482726





TIPOS DE CABLES

AUI (ATTACHMENT UNIT INTERFACE)



Continuing Interf. S.A. & C.V.
T.6. 48877a





TIPOS DE CABLES

CABLE COAXIAL COAXIAL THICK COAXIAL THIN

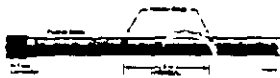

Continuing Interf. S.A. & C.V.
T.6. 48877a





TIPOS DE CABLES

COAXIAL THICK

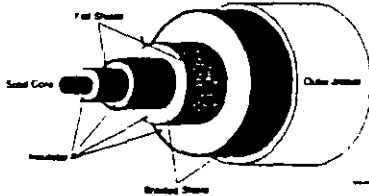

Continuing Interf. S.A. & C.V.
T.6. 48877a



TIPOS DE CONECTORES

T-CONNECTOR

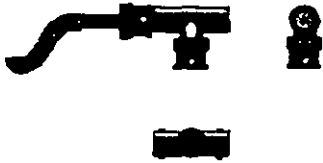

Thin Coax T-Connector

CompuNet S.A. de C.V.
Tel. 4887736



TIPOS DE CABLES

UTP (UNSHIELDED TWISTED PAIR)

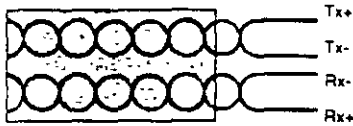

CompuNet S.A. de C.V.
Tel. 4887736



TIPOS DE CABLES

UTP (UNSHIELDED TWISTED PAIR)

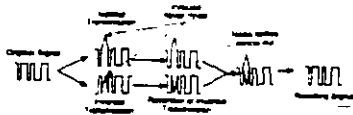

CompuNet S.A. de C.V.
Tel. 4887736



TIPOS DE CABLES

CROSSOVERS

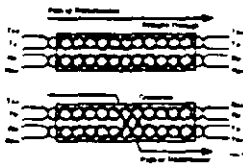

Comunicaciones S.A. de C.V.
T.A. 482776



TIPOS DE CABLES

CABLE DE CUATRO PARES (FOUR-PAIR)

Wire Color	BIA/TIA Pair	Minimum Signal Use	
		ISDA	ISDN
White/Blue (WB-BL)	Pair 1	Not Used	
Blue (BL)			
White/Orange (WO-OR)	Pair 2	EO+	TE+
Orange (OR)		EO-	TE-
White/Green (WG-GR)	Pair 3	TE+	EO+
Green (GR)		TE-	EO-
White/Red (WR-RE)	Pair 4	Not Used	
Red (RE)			

Comunicaciones S.A. de C.V.
T.A. 482776



TIPOS DE CONECTORES

CABLE UTP

- RJ45
- RJ21 (TELCO)

Comunicaciones S.A. de C.V.
T.A. 482776





TIPOS DE CONECTORES

- RJ45

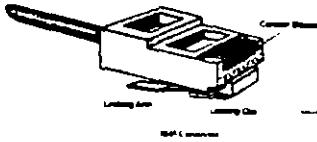

CompuLink Systems S.A. de C.V.
Tel. 4827726





TIPOS DE CONECTORES

- RJ21 (TELCO)

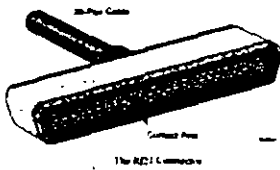

CompuLink Systems S.A. de C.V.
Tel. 4827726





TIPOS DE CONECTORES

- RJ21 (TELCO)

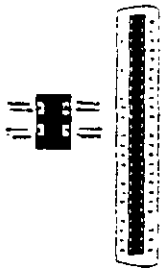

CompuLink Systems S.A. de C.V.
Tel. 4827726





TIPOS DE CABLES

• CATEGORIA 5

- PUEDE SER USADO EN 100BASE-TX NETWORKS
- 22 O 24 AWG WIRE
- ATENUACION MAXIMA A 10 MHZ
- 65 DB/KM
- TEMPERATURA 20°C

CompuNet S.A. de C.V.
Tel. 462736



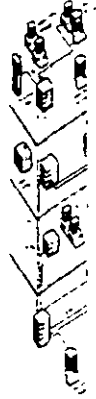

TIPOS DE CABLES

- FIBRA OPTICA
 - UNIMODAL
 - MULTIMODAL



CompuNet S.A. de C.V.
Tel. 462736





TIPOS DE CONECTORES

- FIBRA OPTICA
 - STRAIGHT-TIP
 - SC CONNECTOR

CompuNet S.A. de C.V.
Tel. 462736



TIPOS DE CONECTORES

• STRAIGHT-TIP

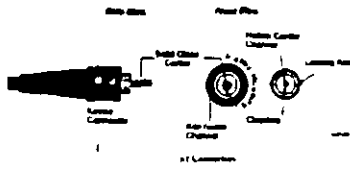

Continuing Systems S.A. de C.V.
Tel: 55537516



TIPOS DE CONECTORES

• SC CONNECTOR

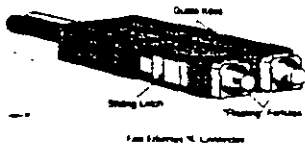

Continuing Systems S.A. de C.V.
Tel: 55537516



Table 4-3. AUI Pinouts

AUI Connector Pin	Wire Function
1	Logic Ref
2	Collision +
3	Transmit +
4	Logic Ref
5	Receive +
6	Power Return
7	No Connection
8	Logic Ref
9	Collision -
10	Transmit -
11	Logic Ref
12	Receive -
13	Power (+12 Vdc)
14	Logic Ref
15	No Connection

Table 4-2. 25-Pair Cable Pair Mapping

Port Number	Wire Use	Wire Color	RJ21 Pin Number	Punchdown In Number	Punchdown Out Number
1	RX +	White/Blue	26	A1	B1
	RX -	Blue/White	1	A2	B2
	TX +	White/Orange	27	A3	B3
	TX -	Orange/White	2	A4	B4
2	RX +	White/Green	28	A5	B5
	RX -	Green/White	3	A6	B6
	TX +	White/Brown	29	A7	B7
	TX -	Brown/White	4	A8	B8
3	RX +	White/Gray	30	A9	B9
	RX -	Gray/White	5	A10	B10
	TX +	Red/Blue	31	A11	B11
	TX -	Blue/Red	6	A12	B12

Table 4-2. 25-Pair Cable Pair Mapping (Continued)

Port Number	Wire Use	Wire Color	RJ21 Pin Number	Punchdown In Number	Punchdown Out Number
4	RX +	Red/Orange	32	A13	B13
	RX -	Orange/Red	7	A14	B14
	TX +	Red/Green	33	A15	B15
	TX -	Green/Red	8	A16	B16
5	RX +	Red/Brown	34	A17	B17
	RX -	Brown/Red	9	A18	B18
	TX +	Red/Gray	35	A19	B19
	TX -	Gray/Red	10	A20	B20
6	RX +	Black/Blue	36	A21	B21
	RX -	Blue/Black	11	A22	B22
	TX +	Black/Orange	37	A23	B23
	TX -	Orange/Black	12	A24	B24
7	RX +	Black/Green	38	A25	B25
	RX -	Green/Black	13	A26	B26
	TX +	Black/Brown	39	A27	B27
	TX -	Brown/Black	14	A28	B28
8	RX +	Black/Gray	40	A29	B29
	RX -	Gray/Black	15	A30	B30
	TX +	Yellow/Blue	41	A31	B31
	TX -	Blue/Yellow	16	A32	B32
9	RX +	Yellow/Orange	42	A33	B33
	RX -	Orange/Yellow	17	A34	B34
	TX +	Yellow/Green	43	A35	B35
	TX -	Green/Yellow	18	A36	B36

Table 4-2. 25-Pair Cable Pair Mapping (Continued)

Port Number	Wire Use	Wire Color	RJ21 Pin Number	Punchdown In Number	Punchdown Out Number
10	RX +	Yellow/Brown	44	A37	B37
	RX -	Brown/Yellow	19	A38	B38
	TX +	Yellow/Gray	45	A39	B39
	TX -	Gray/Yellow	20	A40	B40
11	RX +	Violet/Blue	46	A41	B41
	RX -	Blue/Violet	21	A42	B42
	TX +	Violet/Orange	47	A43	B43
	TX -	Orange/Violet	22	A44	B44
12	RX +	Violet/Green	48	A45	B45
	RX -	Green/Violet	23	A46	B46
	TX +	Violet/Brown	49	A47	B47
	TX -	Brown/Violet	24	A48	B48
Unused Pair	N/A	-	25	N/A	N/A
	N/A	-	50	N/A	N/A

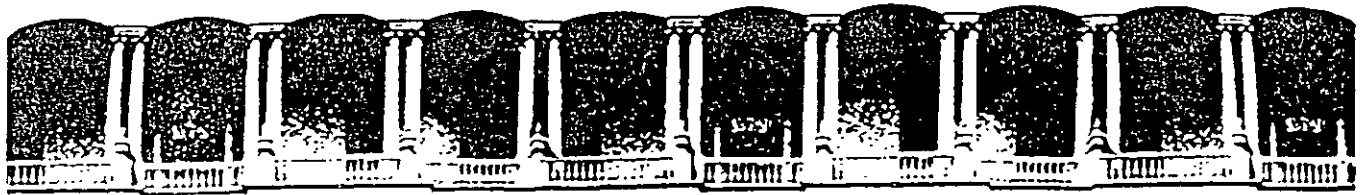

**FACULTAD DE INGENIERIA U.N.A.M.
DIVISION DE EDUCACION CONTINUA**

Cableado Estructurado

Material Suplementario

Noviembre, 2000

PRODUCTOS DEL SISTEMA AVANZADO DE CABLEADO ESTRUCTURADO

DISTRIBUCION HORIZONTAL

- ▣ CABLE DE 4 Y 32 PARES, CAT.5.F.T.P. (ISO 11801)
- ▣ PANELES DE PARCHEO MODULARES (12 Y 24 PUERTOS)
- ▣ JACK MODULAR (4PARES + DRAIN), CAT 5, USO SIN HERRAMIENTA
- ▣ PLACAS DE 2 Y 4 POSICIONES (CON TAPA CIEGA Y ETIQUETA, REGLETAS, RAKS, ETC.

DISTRIBUCION VERTICAL / CAMPUS.

- ▣ FIBRA OPTICA (TIGHT BUFFER, 6 Y 12, ARMADAS Y S/ARMAR)
- ▣ DISTRIBUIDORES DE FIBRA
- ▣ MOJUELOS (REGLETAS) CAT 5 , ETC.

NORMAS Y CERTIFICADOS

TIENE UL, ISO 11801, ISO 9001, NOM, COMPATIBILIDAD ELECTROMAGNETICA

Tabla práctica para calcular la cantidad de cables que caben dentro de distintos diámetros de ductería

φ pulgadas	φ mm	Cable de 4 pares	Cable de 32 pares
1/2	12	0	0
3/4	19	4	0
1	25	6	0
1 1/8	31	10	1
1 1/2	38	16	1
2	50	21	1
2 1/2	63	34	2,3
3	76	50	3
3 1/2	88	-	5
4	101	-	7

- a) Considera longitudes mínimas de 10 y máximas de 30 metros entre registros.
- b) Considera como máximo una suma de dobles de 180° a lo largo de la trayectoria.
- c) Considera registros adecuados en los extremos (no conductes).

ENTENDIENDO EL SISTEMA DE TIERRAS

BASADO EN LAS
OM-001-SEM-2-1994

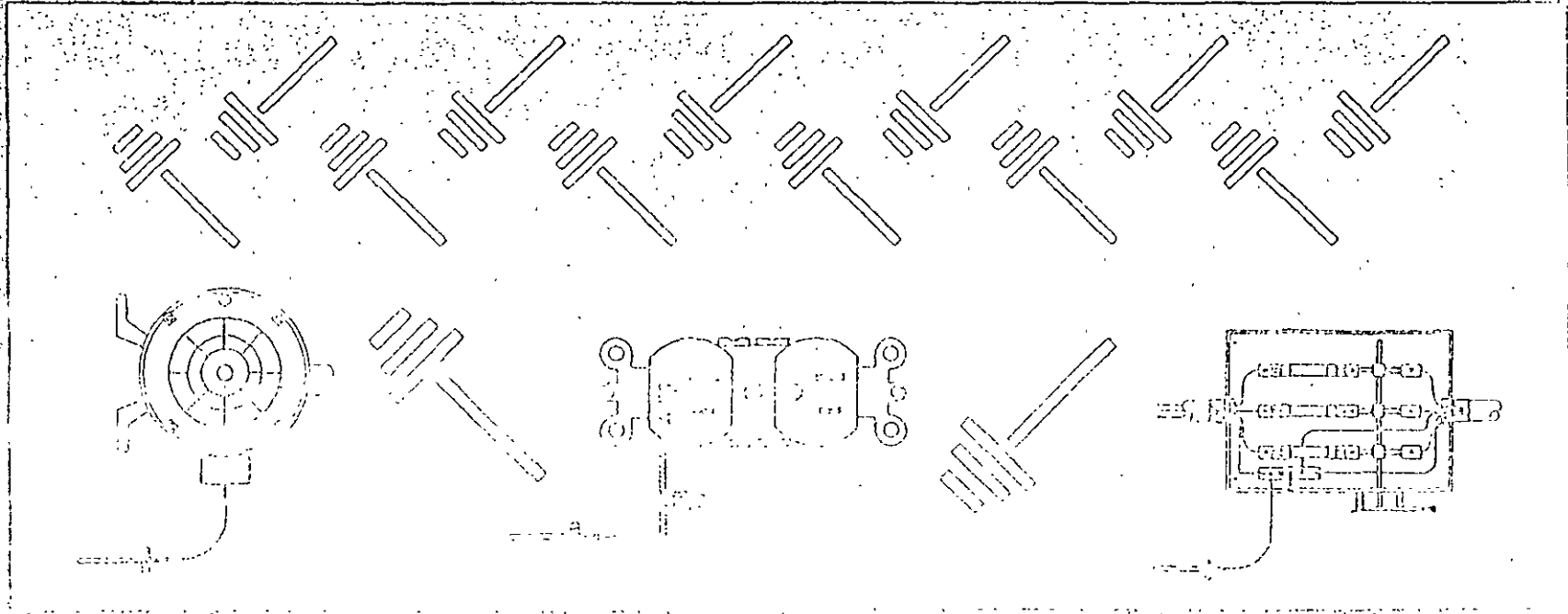

Jesús Velasco Solís

NORMAS GENERALES DE INFRAESTRUCTURA

CIVIL PARA LA CONEXIÓN DE LOS CLIENTES

A LA RED DIGITAL INTEGRADA A TRAVÉS DE

FIBRA OPTICA.

I N D I C E

I ESPECIFICACIONES GENERALES.

*II REQUERIMIENTOS ELÉCTRICOS PARA EQUIPO DE
TRANSMISIÓN Y FUERZA PARA FIBRA ÓPTICA S.*

III SISTEMA DE TIERRA FÍSICA.

IV FIBRA ÓPTICA.

IV.1 ESPECIFICACIONES GENERALES PARA LA FIBRA ÓPTICA.

IV.2 CANALIZACIÓN TÍPICA EN INTERIOR DE INSTALACIONES DE USUARIO.

IV.3 CASO DE TUBERÍA FORZADA A REGISTRO DE TELMEX

IV.4 CANALIZACIÓN TÍPICA EN VÍA PÚBLICA.

I ESPECIFICACIONES GENERALES.

1.- AREA.

Se requiere de un local en el inmueble del usuario con dimensiones mínimas de 15 m². La entrega de este espacio se oficializará mediante la recepción de un plano con la superficie asegurada del área que se entrega, así como las rutas de tubería de fuerza que alimentan al nodo, fibra óptica y/o cable de alta frecuencia para radio.

2.- ACCESO.

El local deberá ser de fácil acceso para personal autorizado solamente, de esta manera se podrán llevar a cabo trabajos de operación y mantenimiento las 24 horas al día los 365 días del año.

3.- OBR. CIVIL.

- a) Firme de concreto $F_c = 200 \text{ Kg/cm}^2$, sin ondulaciones, 3mm. máximo de desnivel, cubierto con loseta vinílica antiestática ó tapete antiestático.
- b) No se recomienda el piso falso, en el caso de que éste exista, la instalación se adaptaría.
- c) De preferencia no deben de existir plafones.
- d) Se requiere al menos un muro de tabique rojo recocido ó de concreto.
- e) En caso de que no se cumpla lo anterior el equipo se deberá anclar al piso y techo.
- f) La altura mínima del local será de 2.40 mts.

TELÉFONOS DE MÉXICO S.A. DE C.V.
RED DIGITAL INTEGRADA

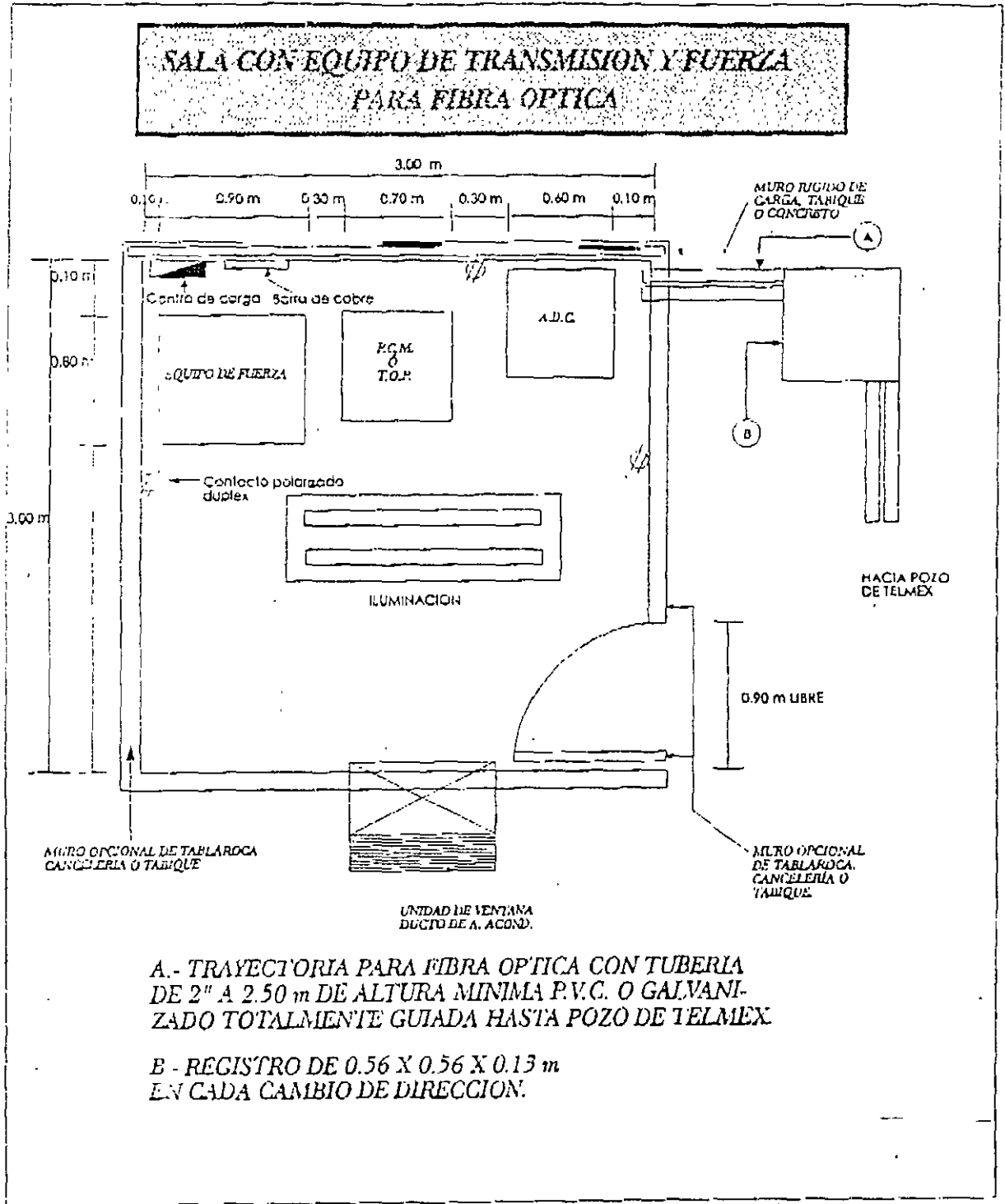

TELÉFONOS DE MÉXICO S.A. DE C.V.
RED DIGITAL INTEGRADA

II. REQUERIMIENTOS ELÉCTRICOS PARA EQUIPO DE
TRANSMISIÓN Y FUERZA PARA FIBRA ÓPTICA.

Los equipos de comunicación a instalar se alimentan con 48VCD. Para obtener este voltaje se instalan dos rectificadores quedando uno de ellos como respaldo. Dependiendo del equipo de comunicación a instalar, el sistema de fuerza requiere de lo siguiente:

1. Alimentación trifásica regulada de 220 Volts. $\pm 5\%$ entre fase y fase.
2. En la acometida se usará cable de calibre 8 TWC.
3. De interruptores termomagnéticos de 2x20 amper. con 220 v. entre fase y fase y 2 de 1 x 15 para contactos polarizados con fases independientes.
4. Cable forrado para tierra física dentro del local del equipo, rematado a una barra de cobre de 16X4X0.25 pulgadas. El calibre del cable deberá ser de 1/0 AWG y en la posición marcada por TELMEX. Ver croquis III de tierra física.
5. Un tablero independiente QO-412 trifásico, a una altura libre de 1.60 mts. a la base del tablero conectado a un tablero general.
6. ~~El consumo general máximo de energía eléctrica será de 3000 Watts.~~
7. El consumo general máximo de energía eléctrica será de 3000 Watts.
8. Todos los sistemas requieren de un par de contactos dobles tipo comerciales de 127 VCA para efectos de instalación.
9. La localización de contactos, tierra física y centro de carga se determinarán en la visita técnica.
10. Se proporcionarán al usuario los conectores coaxiales para que él realice la conexión de su equipo terminal hacia la repisa de distribución del multiplexor de RDI.
11. En todos los casos los equipos deberán de contar con aire acondicionado, temperatura de 18 °C como mínimo y 22 °C máximo.
Humedad máxima de 40% sin condensación.
12. El área mínima necesaria para este equipamiento será de 9 m².



~~10. 16 x 4 x 0.25~~ x ~~10. 16 x 4~~ x 1/4 de Ancho.
dimensiones de la Barra.

III. SISTEMA DE TIERRA FÍSICA

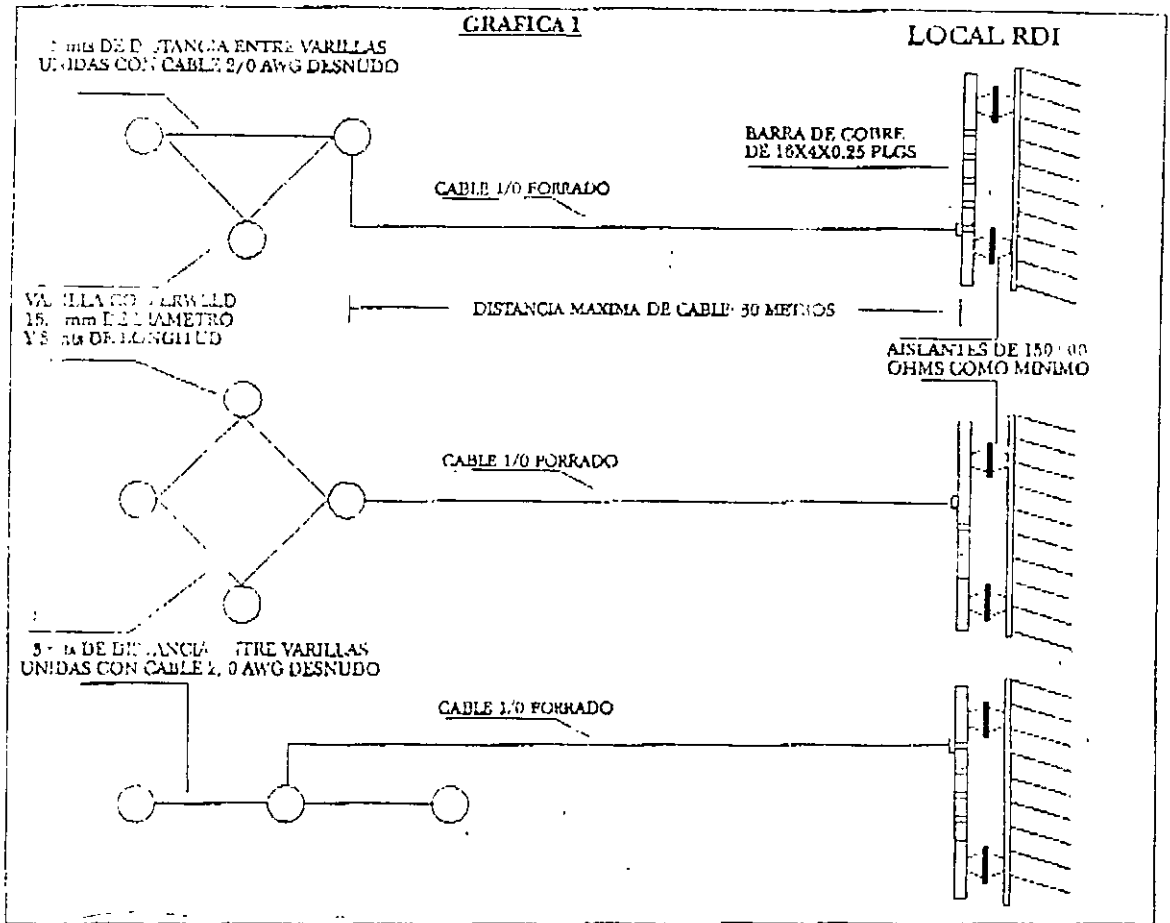

* La calidad de la tierra física proporcionada por el usuario deberá ser menor o igual a 8 ohms, en caso contrario se construirá una hasta obtener dicha impedancia. (ver graficas arriba), estas configuraciones se deben realizar cuando la distancia de la varilla al local de RDI no exceda de 30 mts. en caso de excederse, ver grafica II.

* El cable de la tierra física deberá ser forrado y nunca se deberá acompañar con cables que tengan señales alternas.

* Todo cable de tierra física nunca se deberá pasar a través de ductos metálicos, se recomienda ductería PVC.

* El cable de tierra física nunca deberá de hacer contacto con los muros o varillas del edificio, se deberán utilizar aislantes.

* No deberán existir ángulos de 90 grados en el cable de tierra física.

* El neutro de comision y la tierra física deberán unirse en el centro de carga o tablero principal.

* La distancia máxima del conductor (Cable # 6 color verde) no deberá exceder los 30 metros de longitud desde la barra de tierras hasta el bastidor del equipo, en caso de existir una mayor distancia, se utilizará el cable de 1/0 AWG

III SISTEMA DE TIERRA FÍSICA

DISTRIBUCIÓN IDEAL DE CABLEADOS Y TIERRAS FÍSICAS

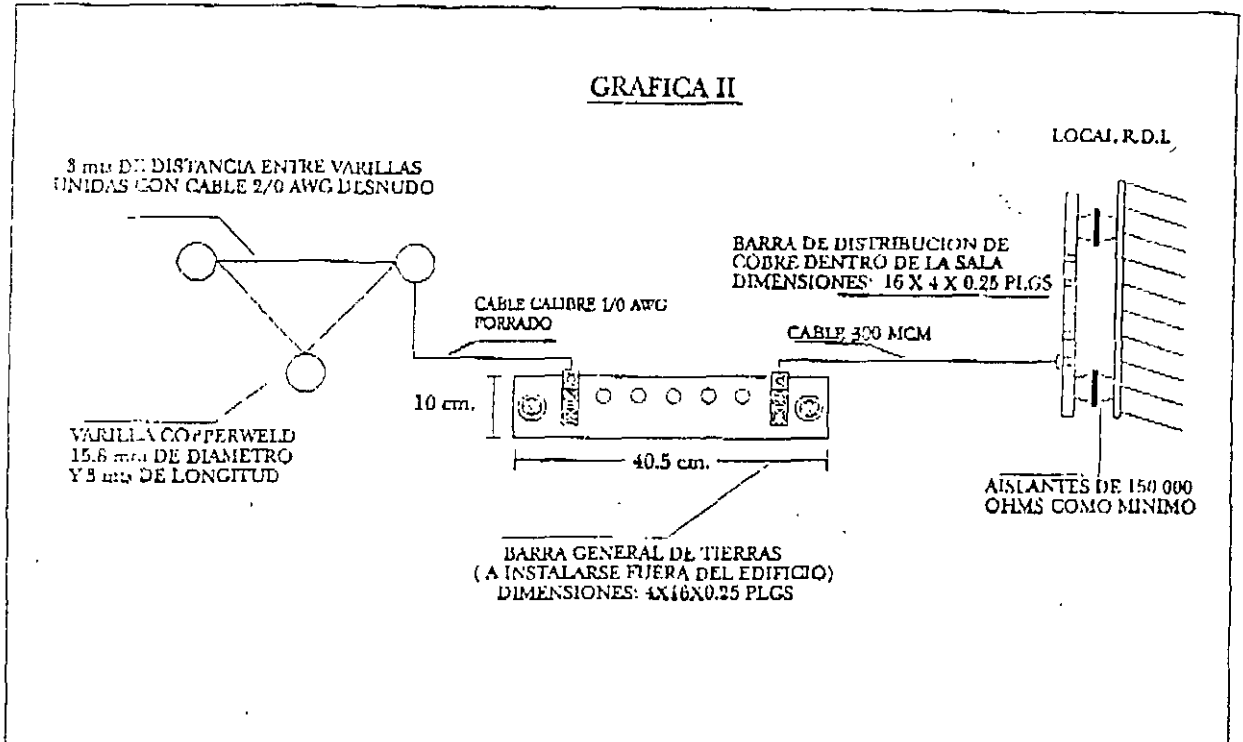

- * Esta distribución se recomienda cuando la distancia entre la tierra física y la sala de RDI es mayor a 30 mts.
- * las dos barras de cobre deberan estar debidamente aisladas. Se recomienda utilizar el aislador tipo barril para 300 voltios.
- * Se debe aislar el cable de tierra física con PVC al pasar a través de la losa.
- * el cable se tendra que etiquetar (TIERRA FÍSICA RDI) con etiquetas que no se desprendan y sean visibles.
- * Se deben utilizar conectores burny de dos hoyos.
- * Se recomienda utilizar conectores ponchables en todas y cada una de las uniones entre el cable y la varilla por ser estos mas seguros y no requieren mantenimiento.
- * La tierra física debe de estar en una zona donde pueda recibir humedad constante, se recomienda una zona de jardín.
- * El lugar donde queden enterradas las varillas deben ser registrables.

IV FIBRA ÓPTICA

IV.1 ESPECIFICACIONES DE CANALIZACIÓN PARA FIBRA ÓPTICA.

1. Toda la tubería deberá ser dos de 2" de diámetro conduit para exteriores y pvc. para interiores y canalización subterránea, totalmente guiada.
2. Los registros deberán ser de $0.56 \times 0.56 \times 0.13$ m en cada cambio de dirección y a cada 20.00 mts. de longitud.
3. Las entradas de la tubería al registro serán por una esquina y saldrán por el extremo contrario.
4. Los radios de curvatura no deberán ser menores a 0.30 m.
5. La tubería deberá conectarse del local de R.D.I. al pozo de TELMEX previamente indicado. En caso de no existir un registro de TELMEX en las cercanías, el usuario construirá un registro de visita. La ubicación y tipo de registro se determinará en la visita técnica.
6. El remate de la tubería deberá de estar a una altura de 2.50 mts.
7. Registros de tabique de $1.40 \times 0.70 \times 0.75$ mts. (Pozo L2T).
8. La trayectoria de la tubería será la más directa.

TELÉFONOS DE MÉXICO S.A. DE C.V.
RED DIGITAL INTEGRADA

CENTRO DE CARGA PARA EQUIPO DE FIBRA OPTICA Y RADIO

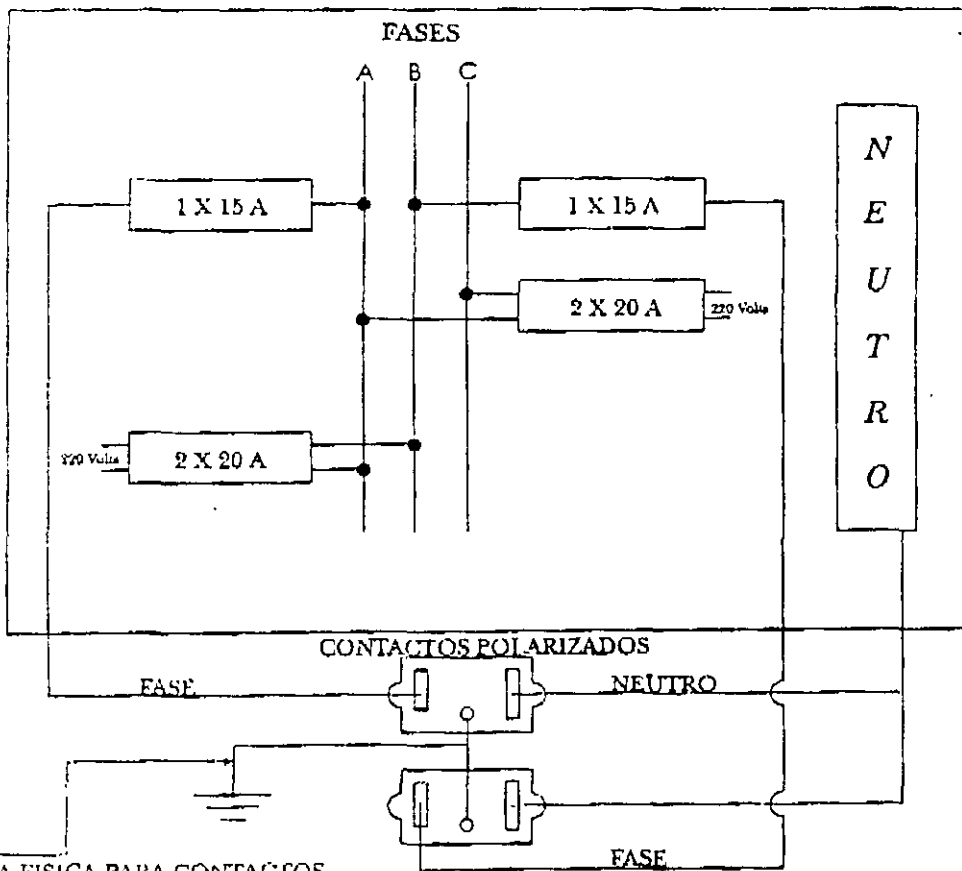

TIERRA FISICA PARA CONTACTOS
POLARIZADOS CON CABLE # 8 AWG

TELÉFONOS DE MÉXICO S.A. DE C.V.
RED DIGITAL INTEGRADA

L3T POZO BAJO BANQUETA L3T

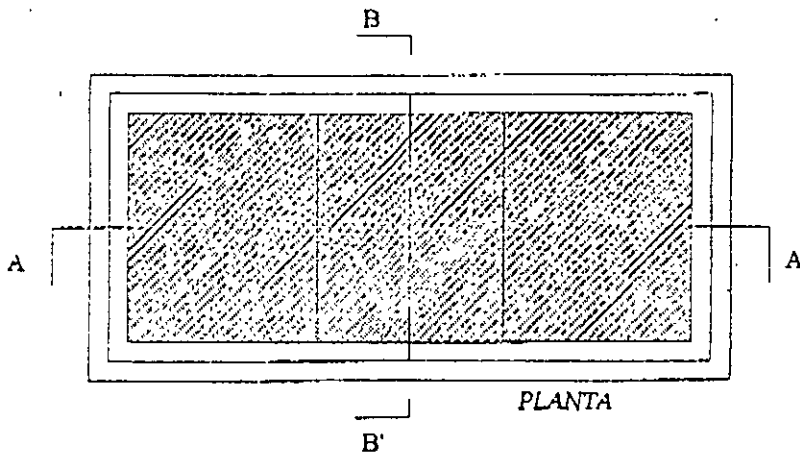
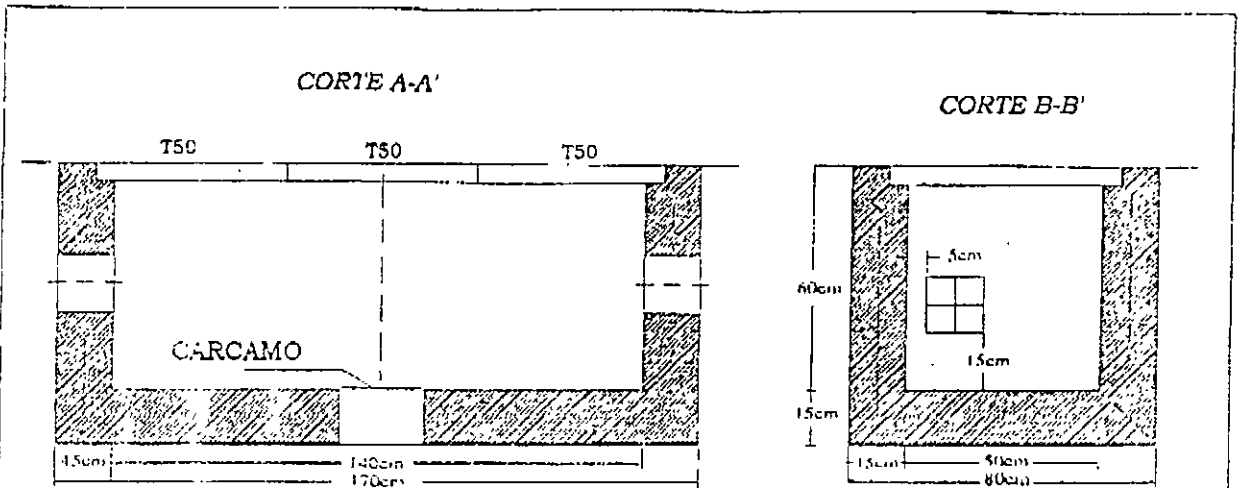

EN CASO DE UTILIZARSE ESTE REGISTRO PARA CAMBIO DE DIRECCION
DUCTERIA DEBERA ENTRAR POR UNA ESQUINA Y SALIR POR LA ESQUINA OPUESTA

TELÉFONOS DE MÉXICO S.A. DE C.V.
RED DIGITAL INTEGRADA

L2T POZO BAJO BANQUETA L2T

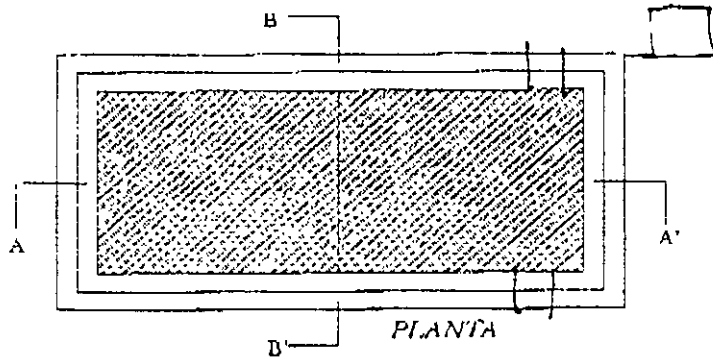
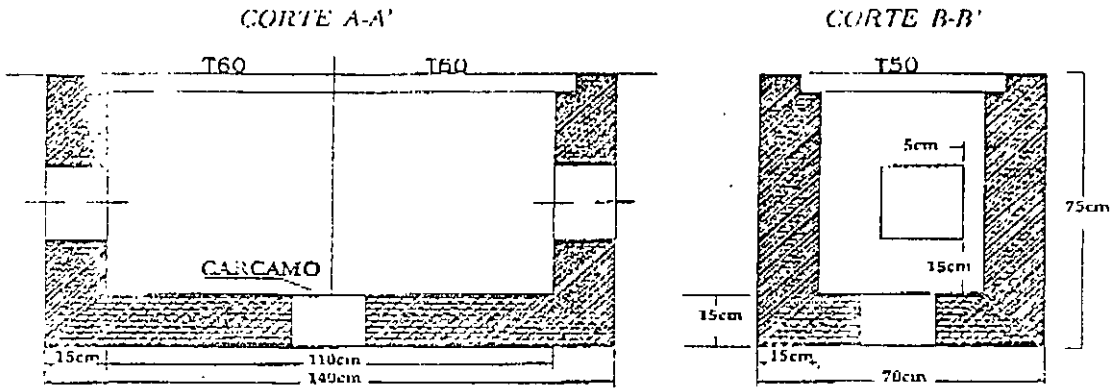

EN CASO DE UTILIZARSE ESTE REGISTRO PARA CAMBIO DE DIRECCION, LA
DUCTERIA DEBERA ENTRAR POR UNA ESQUINA Y SALIR POR LA ESQUINA OPUESTA

TELÉFONOS DE MÉXICO S.A. DE C.V.
RED DIGITAL INTEGRADA

I.I.T. POZO BAJO BANQUETA I.I.T.

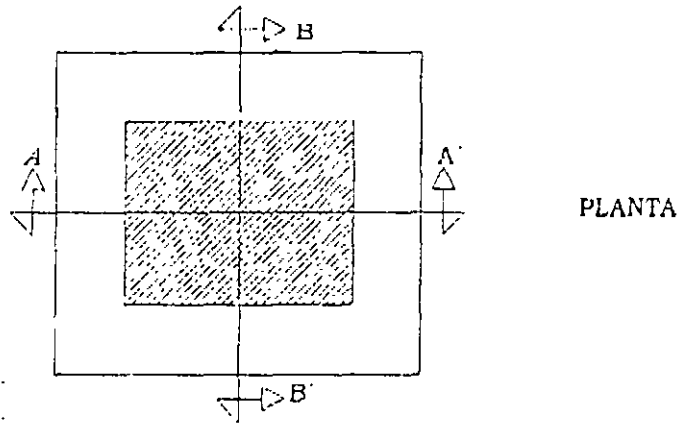
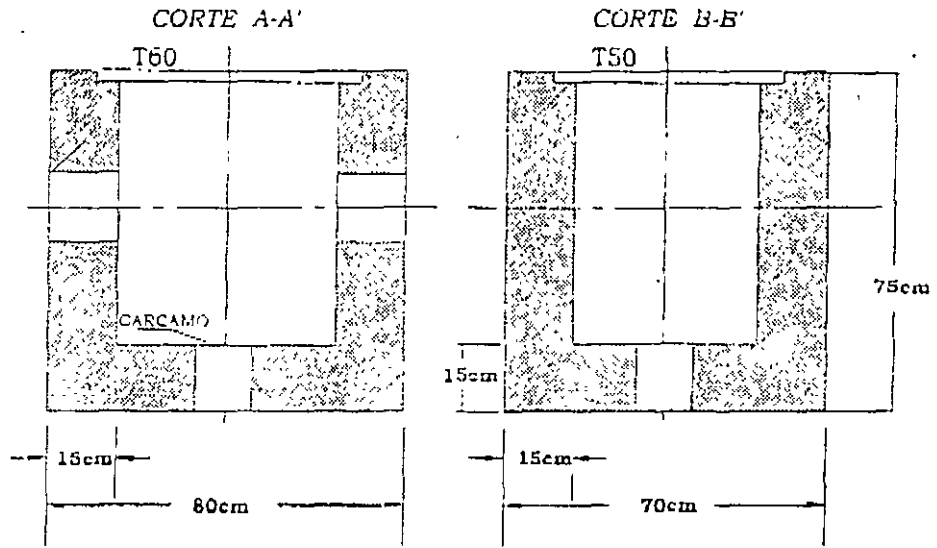

EN CASO DE UTILIZARSE ESTE REGISTRO PARA CAMBIO DE DIRECCION
DUCTERIA DEBERA ENTRAR POR UNA ESQUINA Y SALIR POR LA ESQUINA OPUESTA

V.2 CANALIZACION TIPICA EN INTERIOR DE
INSTALACIONES DE USUARIOS

DUCTERIA O CHAROLAS PARA CABLE OPTICO

DETALLE DE CAMBIO DE TRAYECTORIAS Y DUCTERIA PARA CABLE OPTICO

CASO ESCALERILLA O CHAROLA

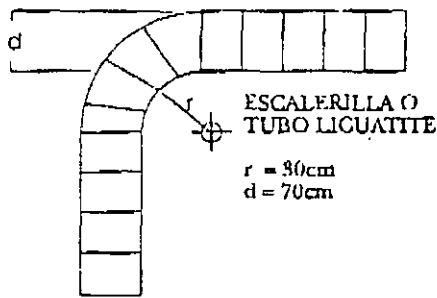

CASO DUCTERIA

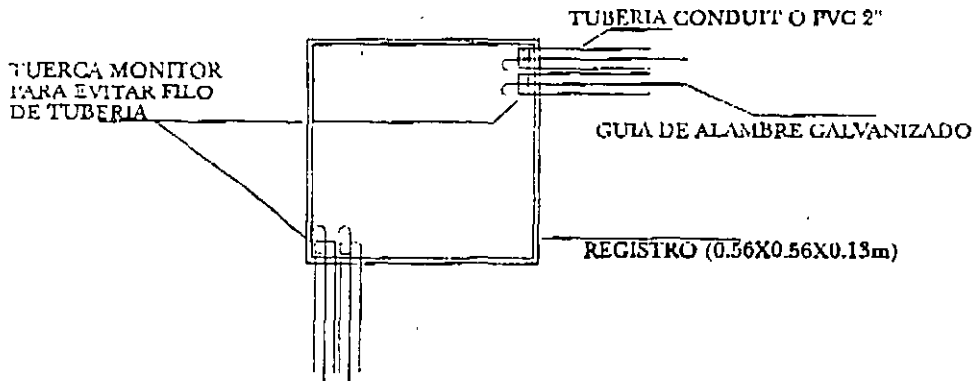

NOTA: LAS TUBERIAS DEBEN INTERCEPTAR EL
REGISTRO TELMEX EN ESQUINAS OPUESTAS
DIAGONALMENTE

IV.3 CASO DE TUBERÍA FORZADA A REGISTRO TELMEX

SE UTILIZA EL REGISTRO L2F COMO EJEMPLO

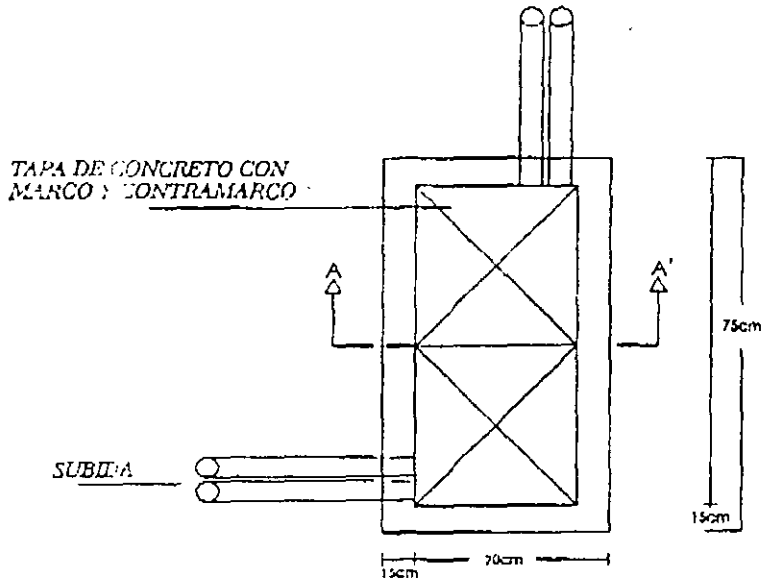

CORTE SUPERIOR

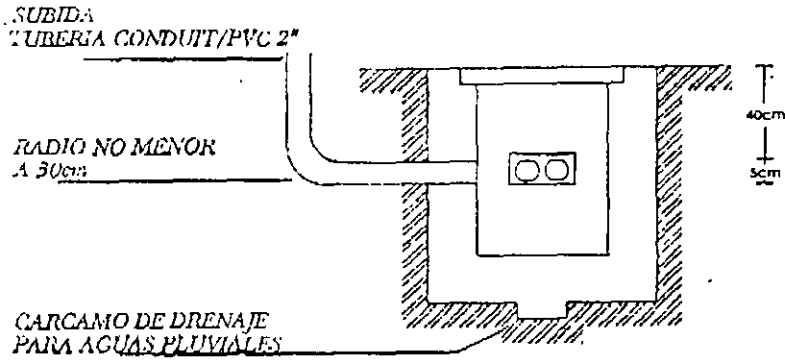

CORTE A-A'

TELÉFONOS DE MÉXICO S.A. DE C.V.
RED DIGITAL INTEGRADA

IV.4 CANALIZACIÓN TÍPICA EN VÍA PÚBLICA PARA LA INMERSIÓN DE FIBRA ÓPTICA

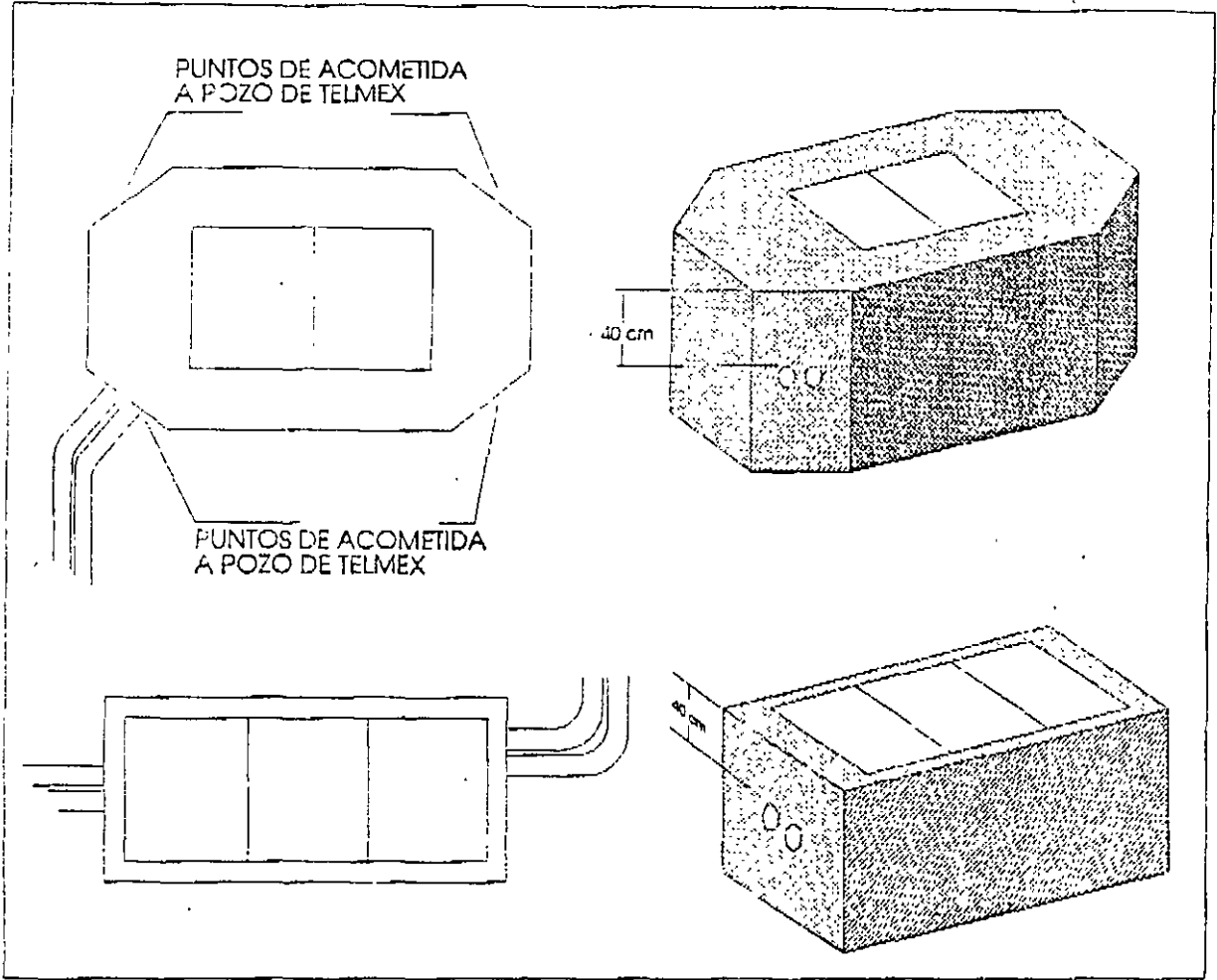

LA CANALIZACIÓN SE DEBERA REALIZAR POR EL CENTRO DE LA BANQUETA Y SI SE PRESENTARA ALGUNA INSTALACION AJENA A TELMEX SE RESPETARA Y SE HARA UN DESVIO LATERAL SIN DAÑARLA



COLOCACION CORRECTA DE REGISTROS PARA FIBRA OPTICA

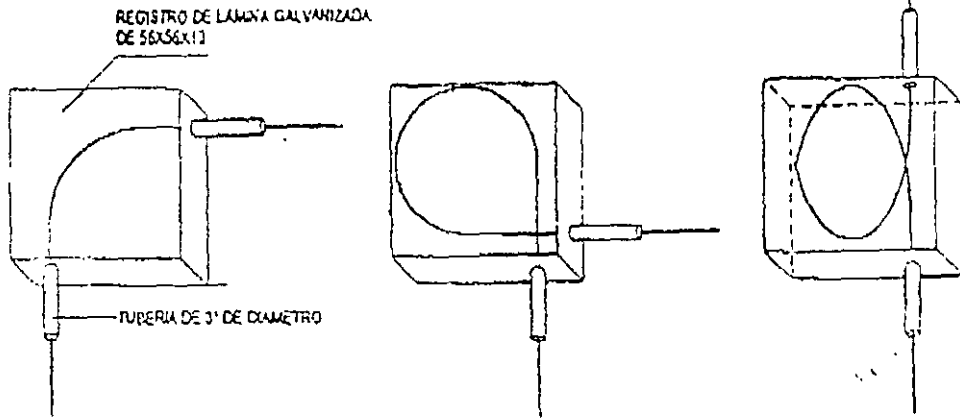

COLOCACION INCORRECTA DE REGISTROS PARA FIBRA OPTICA

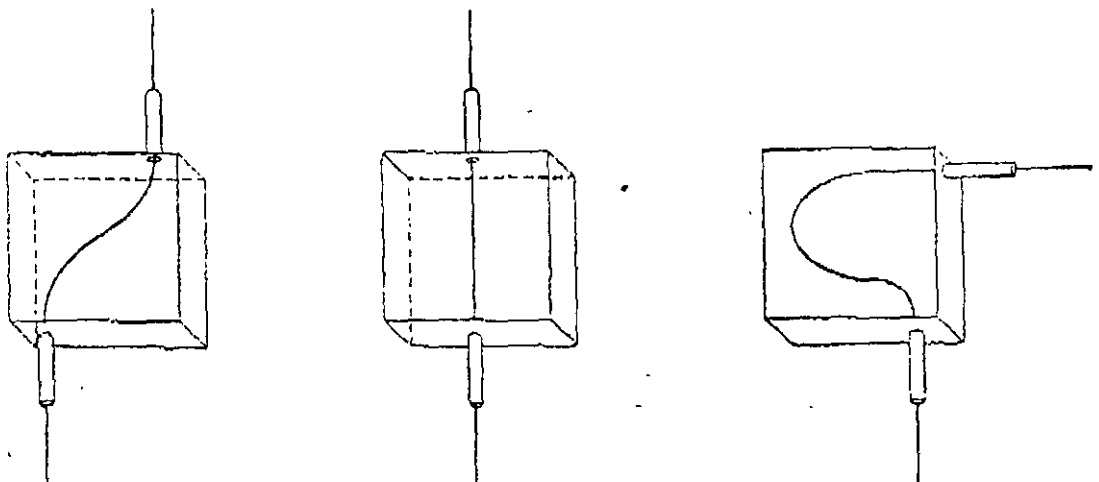

NOTA: NO SE ACEPTARA NINGUN REGISTRO CON ESTA COLOCACION

NOMBRE TELEFONISTA

NOMBRE USUARIO



USUARIO:

DOMICILIO:

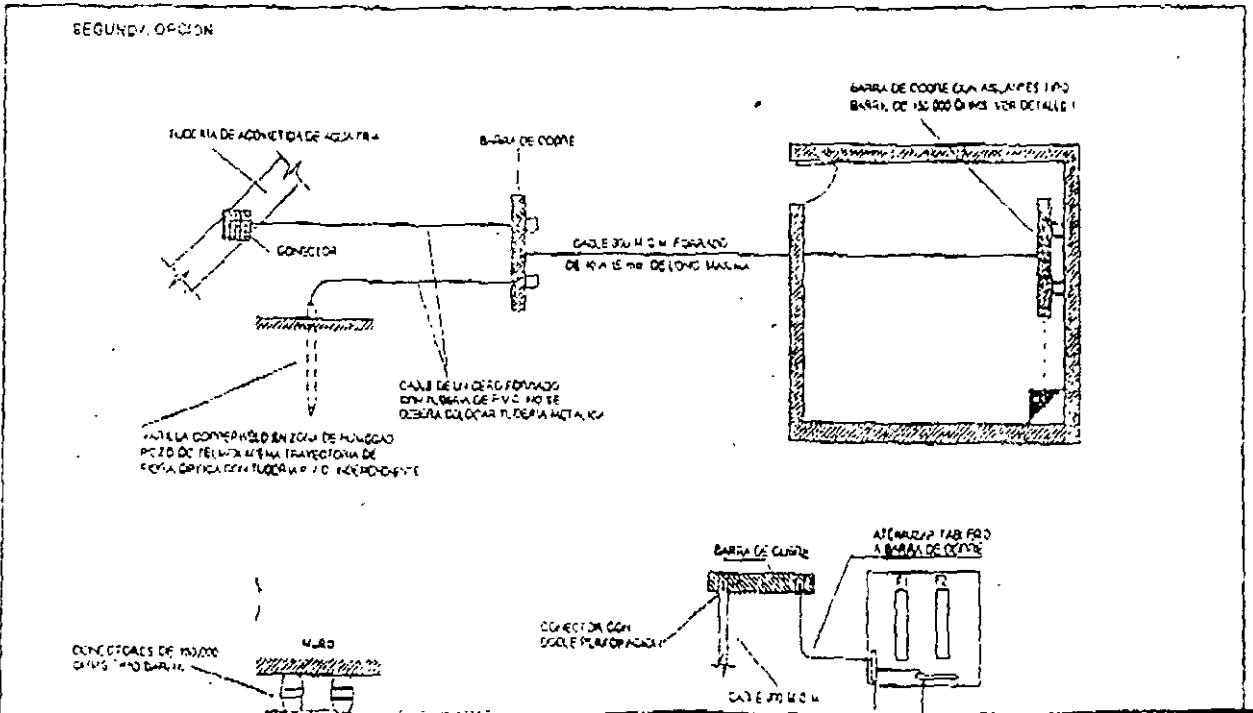
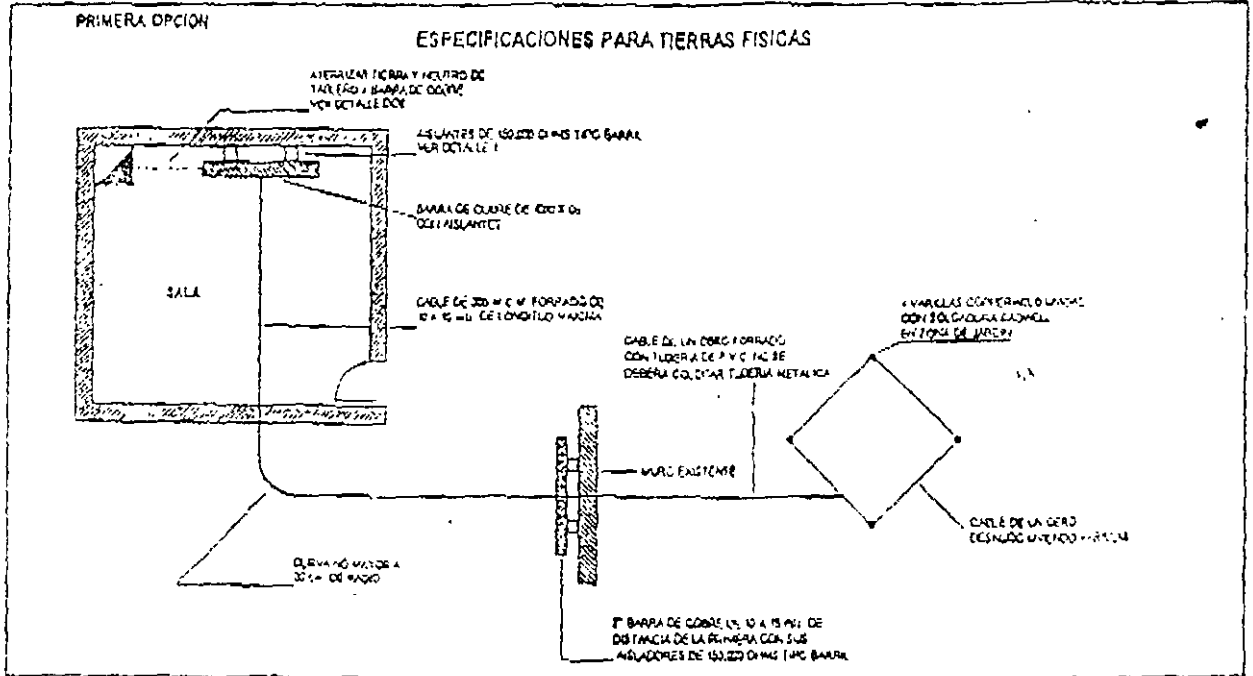

COLOCACION CORRECTA DE REGISTROS PARA FIBRA OPTICA

REGISTRO DE LAMINA GALVANIZADA DE 56X56X13cm

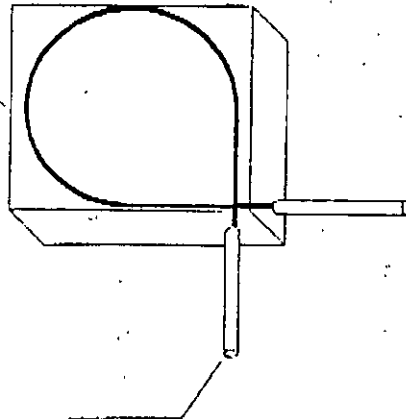

DUCTERIA DE 2" DE DIAMETRO

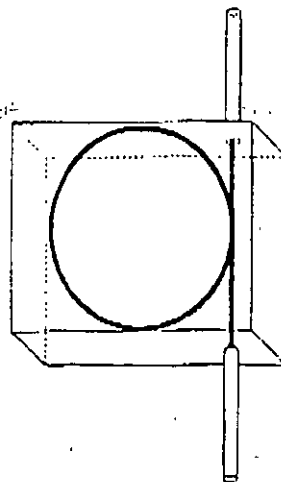
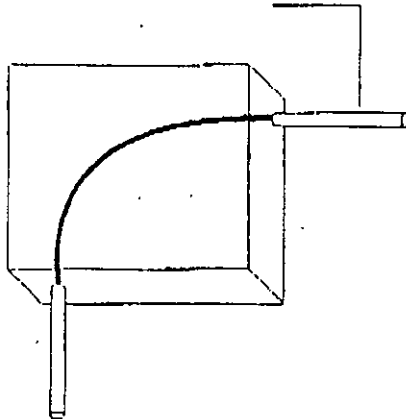



ESPECIFICACIONES PARA FIBRA OPTICA.

1. Toda la tubería deberá ser de 3" de diámetro conduit y totalmente guiada
2. Los registros deberán ser de 0.56 x 0.56 x 0.13 M. en cada cambio de dirección y A/C 20.00 M. de longitud.
3. Las entradas de tubería a registro será por una esquina y salir por extremo contrario.
4. Los radios de curvatura no deberán ser menores a 0.30 M.
5. La tubería de 3" de diámetro deberá conectarse al pozo de TELMEX indicado.
6. Registros de tabique de 0.60 x 0.80 x 1.00 M.

7. La tierra para equipo deberá de ser independiente forrada con 5 ohms de resistencia máxima

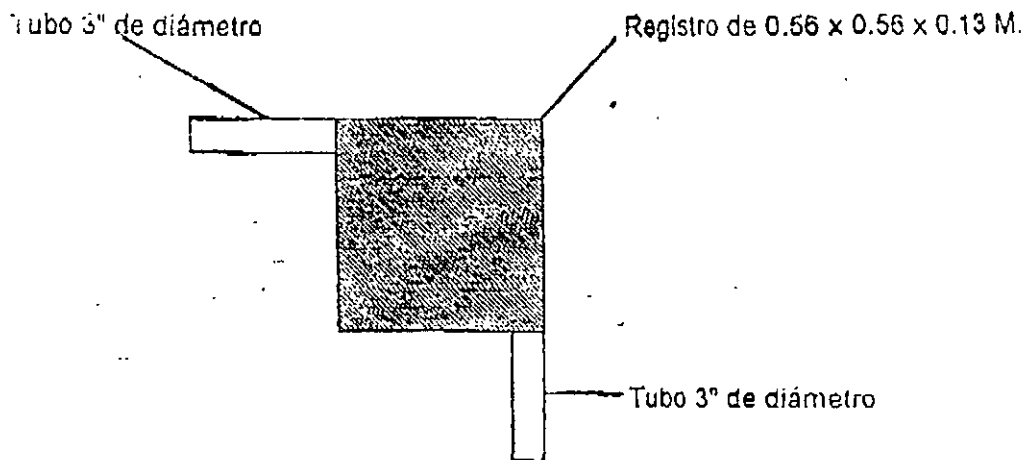

8. La trayectoria de tubería será la mas directa, del pozo a la sala.



TELEFONOS DE MEXICO S.A. DE C.V.
GERENCIA DE INSTALACIONES INTERNAS DE USUARIOS

ESPECIFICACIONES PARA BASE DE CONTENEDOR

USUARIO:

DOMICILIO:

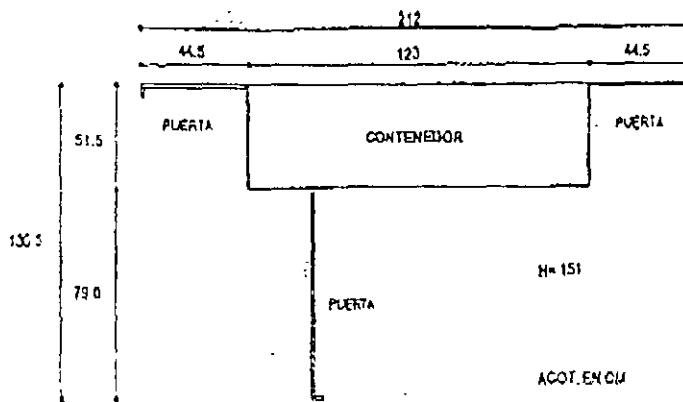

CONTENEDOR VISTA EN PLANTA

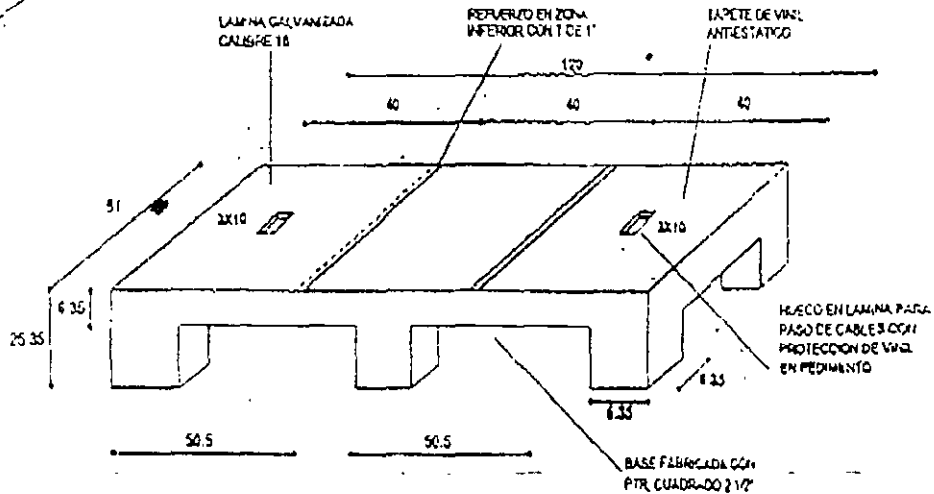

BASE PARA CONTENEDOR



TELEFONOS DE MEXICO, S.A. de C.V.

SUBDIRECCION DE ASESORIA Y SERVICIO A CLIENTES
GERENCIA DE INSTALACIONES INTERNAS DE USUARIOS