



**FACULTAD DE INGENIERIA U.N.A.M.  
DIVISION DE EDUCACION CONTINUA**

**CURSOS INSTITUCIONALES**

**No. 39**

**MANTENIMIENTO DE HARDWARE**

**DEL 8 AL 13 DE JUNIO**

**UNIVERSIDAD AUTONOMA DEL ESTADO DE MEXICO**

**MATERIAL DIDACTICO**

**MEXICO, D.F.  
PALACIO E MINERIA  
1992**

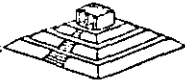

CURSO PARA PERSONAL PROFESIONAL DE LA

UNIVERSIDAD AUTONOMA DEL ESTADO DE MEXICO

"MANTENIMIENTO DE PC's Y PERIFERICOS AVANZADO"

**INTRODUCCION**

CURSO PARA PERSONAL PROFESIONAL DE LA

UNIVERSIDAD AUTONOMA DEL ESTADO DE MEXICO

"MANTENIMIENTO DE PC's Y PERIFERICOS AVANZADO"

### OBJETIVOS

Obtener de los participantes el perfil medio de conocimientos con base a un evento de retroalimentación (TEST), a efecto de lograr la plataforma de partida, firme y bien orientada que permita un buen aprovechamiento.

Reafirmar en el grupo los conocimientos previos del tema y elevar su gradiente con tópicos y tendencias de actualidad; reforzándolo con teoría y principalmente prácticas, en cada apartado del temario, a efecto de que consolide los hábitos adecuados en el mantenimiento preventivo y correctivo básico-medio de sus equipos, sin pretender llegar a detalles de alto nivel en el campo de la Ingeniería del Hardware para Microcomputadoras.

Lograr que los participantes estén ciertos de que no se debe abusar de la confianza adquirida, ni perderle el respeto a los equipos, ya que durante el desarrollo del curso deberán ir aplicando con seguridad, los conocimientos logrados, sin el mínimo riesgo para el hardware.



CURSO PARA PERSONAL PROFESIONAL DE LA  
UNIVERSIDAD AUTONOMA DEL ESTADO DE MEXICO

MANTENIMIENTO DE PC's Y PERIFERICOS AVANZADO.

**TEMARIO**

- 1.- EVALUACIÓN PREVIA DEL GRUPO
- 2.- REPASO Y CONSOLIDACIÓN DE CONCEPTOS

- 2.1.- Arquitectura de una computadora
- 2.2.- Características de los equipos: AT-286, 386, 486, 586, PS/2
- 2.3.-Tecnologías ISA,EISA,MCA, SPARC,RISC.Cuadro comparativo.
- 2.4.- Inventario-diagnóstico de control
- 2.5.- Sección de práctica.

3.- HERRAMIENTAS DE DIAGNÓSTICO .

- 3.1- Programas de diagnóstico .
- 3.2 .- "EPROM's" de Diagnóstico.
- 3.3.- Rutinas al BIOS; poderosa herramienta.
- 3.4.- Equipos de Diagnóstico.
- 3.5.- Sección de Práctica.

4.-CONTROLADORES PRINCIPALES Y SISTEMAS MÍNIMOS.

- 4.1.-Controlador de Bus.
- 4.2.- Controlador de DMA.
- 4.3.- Generador de Reloj.
- 4.4.- Controlador Programable de Periféricos.
- 4.5.- Controlador de Unidades de Disco.
- 4.6.- Controlador de Teclado.
- 4.7.-Sección de Práctica con manejo de Osciloscopio y Puntas Lógicas



**5.- PERIFÉRICOS Y AJUSTES PRINCIPALES.**

- 5.1.- Monitores.
- 5.2.- Unidades de Disco.
- 5.3.- Impresores.
- 5.4.- Sección de Práctica con manejo de Dispositivos de Diagnóstico y Alineación.

**6.- MANTENIMIENTO CORRECTIVO BÁSICO-MEDIO..**

- 6.1.- Diagramas.
- 6.2.- Señales de Prueba y Diagnóstico.
- 6.3.- Microcontroladores, relojes y bases de tiempo.
- 6.4.- Tendencias del Servicio y Metodología Práctica.
- 6.5.- Sección de Práctica.

**7.- DISCOS DUROS.**

- 7.1.- Principales Tecnologías y sus características.
- 7.2.- Fallas de origen y mantenimiento físico.
- 7.3.- Mantenimiento Lógico.
- 7.4.- Utilerías y Software de apoyo.

**PROFESORES:**

Ing. Juan F. Magaña Carrillo  
Ing. Saul S. Magaña Cisneros

**APOYO TECNICO:**

Francisco G. Magaña Durán  
Pedro Huerta Anguiano  
Adrián F. Magaña Cisneros



# Arquitectura de una computadora

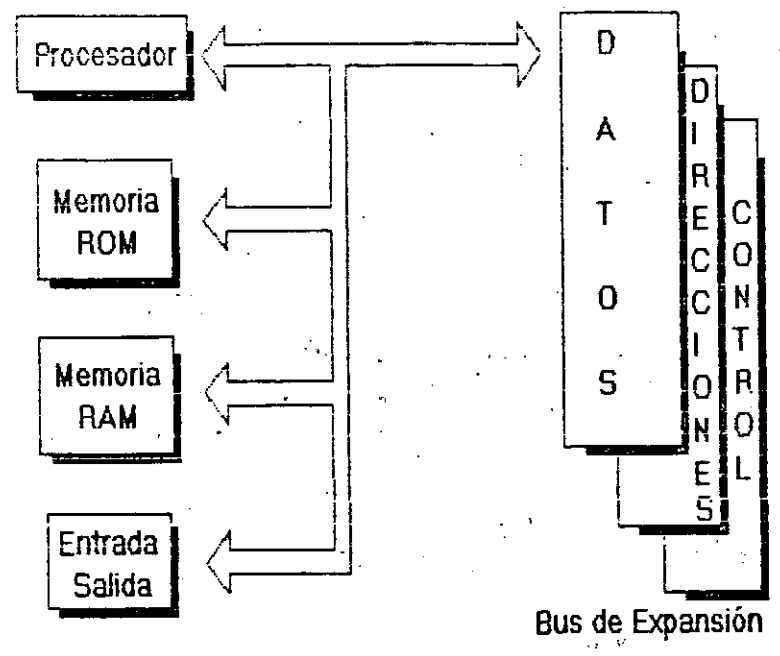
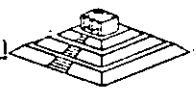

apuntes

# Arquitectura de una computadora



BLOCK DIAGRAM

ATTACHMENT II

B.1 System Block Diagram

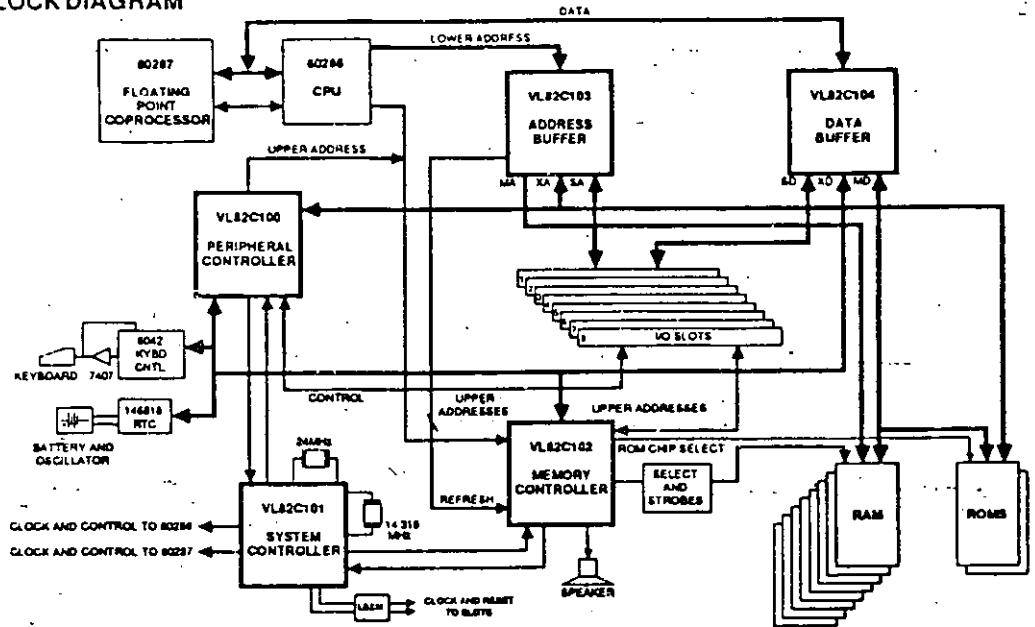

apuntes

# Mapa de memoria XT (RAM)

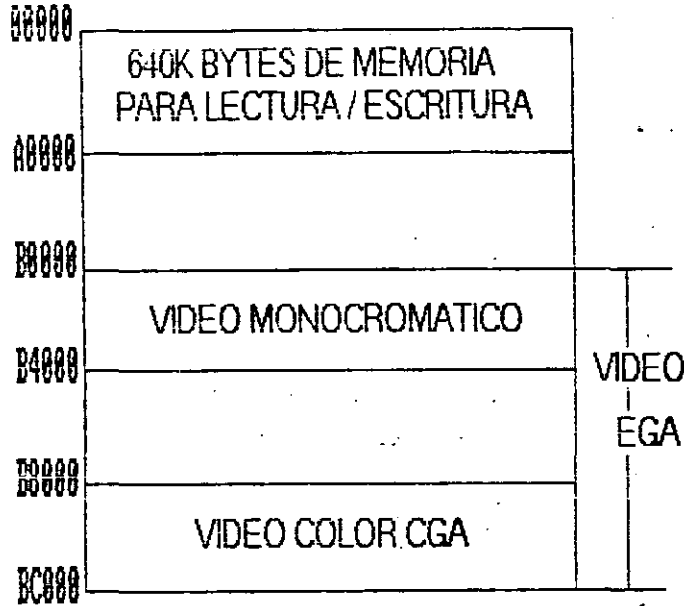
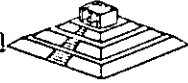

apuntes



# Mapa de memoria XT (ROM)

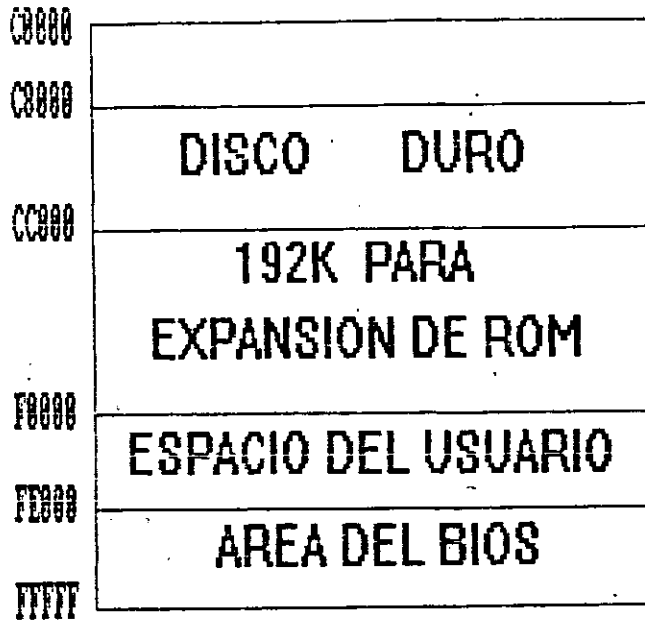

apuntes

# Arquitectura de una computadora



## C.1 System Memory Map

Address Range	Start-End	Name	Function
000000-03FFFF	000K-256K	Bank 0	System memory (256K)
040000-07FFFF	256K-512K	Bank 1	System memory (256K)
080000-09FFFF	512K-640K	Bank 2	System memory (128K)
0AFFFF-0BFFFF	640K-768K	Video	Display card buffer (128K)
0C0000-0DFFFF	768K-896K	I/O ROM	Expansion ROM (128K)
0E0000-0EFFFF	896K-960K	ROM	System usage (64K)
0F0000-0FFFFFFF	960K-1024K	ROM	BIOS (64K)
100000-11FFFF	1024K-1152K	Bank 2	System memory (128K)
120000-15FFFF	1152K-1408K	Bank 3	System memory (128K)
160000-FDFFFF	1408K-16146K	RAM	Expansion RAM (14870K)
FE0000-FEFFFF	16146K-16210K	ROM	System usage (64K)
FF0000-FFFFFFF	16210K-16274K	ROM	BIOS (64K)

apuntes

# Arquitectura de una computadora

## D.1 I/O Address Map



Hex Range	Devices	Usage
000-01F	DMA Controller 1	System
020-03F	Interrupt controller 1	System
040-05F	Timer	System
060-06F	8042 (keyboard)	System
070-07F	Real time clock, NMI mask	System
080-09F	DMA page register	System
0A0-0BF	Interrupt controller 2	System
0C0-0DF	DMA controller 2	System
0F0	Clear math Coprocessor busy	System
0F1	Reset math coprocessor	System
0FB-0FF	Math coprocessor	System
1F0-1F8	Fixed disk	I/O
200-207	Game I/O	I/O
278-27F	Parallel printer port 2	I/O
2F8-2FF	Serial port 2	I/O
300-31F	Prototype card	I/O
360-36F	Reserved	I/O
378-37F	Parallel printer port 1	I/O
380-38F	SDLC, bisynchronous 2	I/O
3A0-3AF	Bisynchronous 1	I/O
3B0-3BF	Monochrome display and printer adapter	I/O
3C0-3CF	Reserved	I/O
3D0-3DF	Color/graphics monitor adapter	I/O
3F0-3F7	Diskette controller	I/O
3FB-3FF	Serial port 1	I/O

apuntes

# Arquitectura de una computadora bus XT

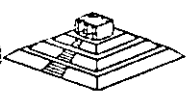

REAR PANEL

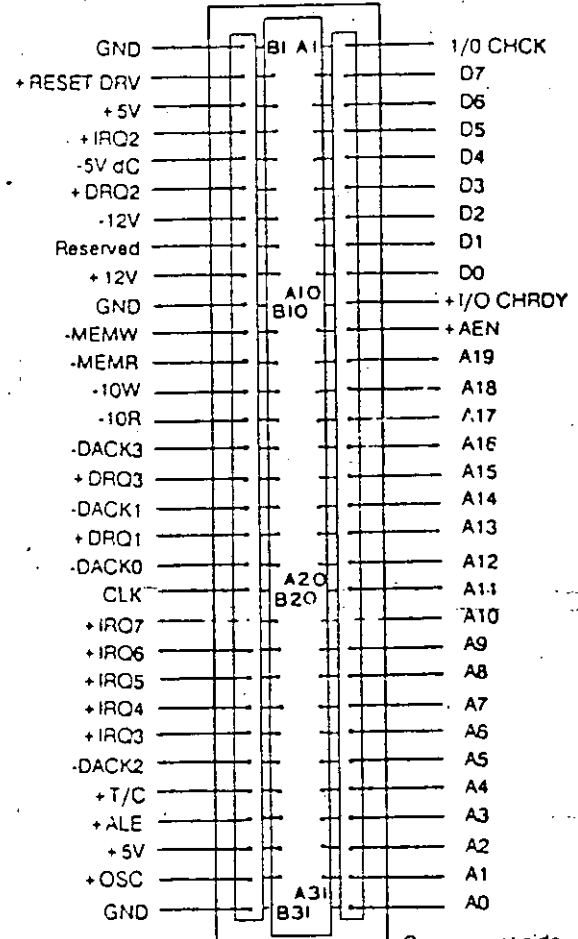

Component side (B)

I/O CHANNEL SLOT

apuntes

# Arquitectura de una computadora



## D.2 I/O Channel

### Rear Panel

GND	B1	A1	-I/O CH CK
RESET DRV	B2	A2	SD7
+5Vdc	B3	A3	SD6
IRQ2	B4	A4	SD5
-5Vdc	B5	A5	SD4
DRQ2	B6	A6	SD3
-12Vdc	B7	A7	SD2
OWS	B8	A8	SD1
+12Vdc	B9	A9	SD0
GND	B10	A10	-I/O CH RDY
-SMEMW	B11	A11	AEN
-SMEMR	B12	A12	SA19
-IOW	B13	A13	SA18
-IOR	B14	A14	SA17
-DCK3	B15	A15	SA16
DRQ3	B16	A16	SA15
-DACK1	B17	A17	SA14
DRQ1	B18	A18	SA13
-REFRESH	B19	A19	SA12
CLK	B20	A20	SA11
IRQ7	B21	A21	SA10
IRQ6	B22	A22	SA9
IRQ5	B23	A23	SA8
IRQ4	B24	A24	SA7
IRQ3	B25	A25	SA6
-DACK2	B26	A26	SA5
T/C	B27	A27	SA4
BALE	B28	A28	SA3
+5Vdc	B29	A29	SA2
OSC	B30	A30	SA1
GND	B31	A31	SA0

slot 1 - slot 8

apuntes

# Arquitectura de una computadora



-MEMCS16	D1	C1	SBHE
I/O CS16	D2	C2	LA23
IRQ16	D3	C3	LA22
IRQ11	D4	C4	LA21
IRQ12	D5	C5	LA20
IRQ15	D6	C6	LA19
IRQ14	D7	C7	LA18
-DACK0	D8	C8	LA17
DRQ0	D9	C9	-MEMR
-DACK5	D10	C10	-MEMW
DRQ5	D11	C11	SD08
-DACK6	D12	C12	SD09
DRQ6	D13	C13	SD10
-DACK7	D14	C14	SD11
DRQ7	D15	C15	SD12
+5Vdc	D16	C16	SD13
-MASTER	D17	C17	SD14
GND	D18	C18	SD15

slot 10 - slot 15

apuntes

# Arquitectura de una computadora



## E.1 DMA Channels

Channel	Function
0	Spare (8-bit transfer)
1	SDLC (8-bit transfer)
2	Floppy disk (8-bit transfer)
3	Spare (8-bit transfer)
4	Cascade for DMA controller
5	Spare (16-bit transfer)
6	Spare (16-bit transfer)
7	Spare (16-bit transfer)

## E.2 DMA Controller Registers

Hex Address	Command Codes
0C0	CH0 base and current address
0C2	CH0 base and current word count
0C4	CH1 base and current address
0C6	CH1 base and current word count
0C8	CH2 base and current address
0CA	CH2 base and current word count
0CC	CH3 base and current address
0CE	CH3 base and current word count
0D0	Read status register/Write command register
0D2	Write mode register
0D4	Read temporary registers/write command register
0D6	Write mode register
0D8	Clear byte pointer flip-flop
0DA	Read temporary register/Write mask clear
0DC	Clear mask register
0DE	Write all mask register bits

apuntes

# Arquitectura de una computadora



## E.3 Page Register Addresses

Page Register	i/O Hex Address
DMA Channel 0	0087
DMA Channel 1	0083
DMA Channel 2	0081
DMA Channel 3	0082
DMA Channel 5	008B
DMA Channel 6	0089
DMA Channel 7	008A
Refresh	008F

## E.4 Interrupts

Level	Function
0	System timer output 0
1	Keyboard output buffer full
2	Interrupt from controller 2 (level 8-15)
3	Serial port 2
4	Serial port 1
5	Parallel port 2
6	Diskette controller
7	Parallel port
8	Real-time clock
9	Software redirected to INT 0AH
10	Reserved
11	Reserved
12	Reserved
13	30287
14	Hard disk drive
15	Reserved

apuntes



# Arquitectura de una computadora



## E.5 Timers

Channel	Function
0	System timer
1	Refresh request generator
2	Tone generation for speaker

apuntes

# Características de los Procesadores

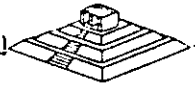

---

---

---

---

---



\* Modo REAL      \*Modo PROTEGIDO

---

---

---

---

---



---

---

---

---

---



---

---

---

---

---

apuntes

# Características de las distintas arquitecturas

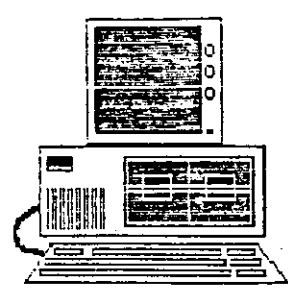
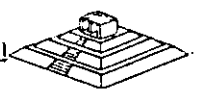

## XT 8088

- \* Liberación: 1982
- \* Direccionamiento: 1MB
- \* Memoria Usuario: 640KB
- \* Almacenamiento:  
32MB (MS-DOS 2.xx)  
70MB (MS-DOS 3.xx)
- \* Velocidad: de 4.77 a 10 Mhz.
- \* \$:

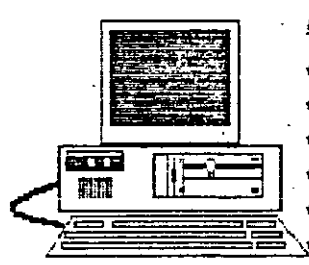

## AT 80286

- \* Liberación: 1986
- \* Direccionamiento: 16MB
- \* Memoria Usuario: 15MB
- \* Almacenamiento: 2GB
- \* Velocidad: de 8 a 16 Mhz.
- \* \$:

apuntes

# Características de las distintas arquitecturas

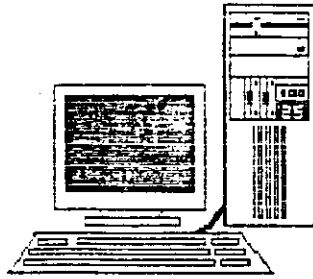
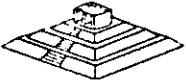

## AT 80386-80386/SX

- \* Liberación: 1982
- \*Direccionamiento: 4GB
- \* Memoria Usuario:  
Limitante Tecnológica
- \* Almacenamiento: en TB
- \* Velocidad: de 16 a 30 Mhz.
- \* \$:

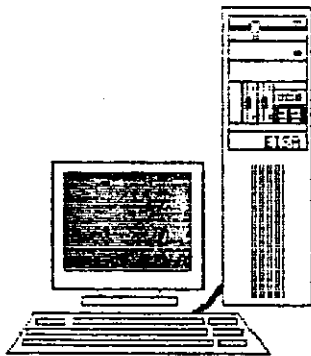

## AT 80486

- \* Liberación: 1990
- \* Características  
Similares al 386
- \* Incluye Memoria Caché  
y Coprocesador
- \* Tecnología: RISC
- \* Velocidad: de 25 a 55 Mhz.
- \* \$:

apuntes

# Principales Periféricos Características

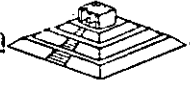

IMPRESORES

*Paralelo / Serial*  
*Impacto / No Impacto*  
*Vel. de impresión (c.p.s.)*  
*Tipo de Alimentación*  
*Buffer*



MODEMS

*Homologados*  
*Internos / Externos*  
*Vel. de Transmisión (B.p.s.)*  
*Protocolo*  
*Inteligentes*  
*Niveles de M.P.N.*



CONTROLADORES

*Dependiendo del tipo; se ponderan varios puntos.*



UNIDADES DE ALMACENAMIENTO Y/O RESPALDO

*Capacidad*  
*Tecnología*  
*Velocidad*  
*Costo*

apuntes

# Configuración switches XT



The locations of the two switches are shown in the following illustration of the system board.

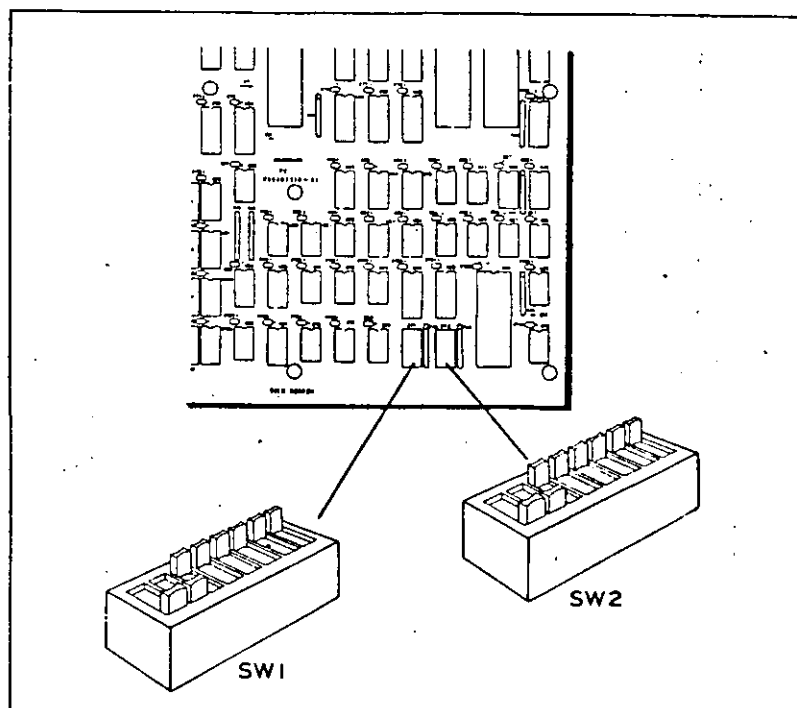

Fig. Locations of the DIP switches

apuntes

# Configuración switches XT



## A.3 Descriptions of the corresponding DIP Switches

### 1) SW1 -- DIP Switch One

<u>Switch No.</u>	<u>Default Setting</u>	<u>Function</u>
SW1-1	OFF	Enables disk drive.
SW1-2	ON	Disables 8087 interrupt.
SW1-3	*	(SW1-3 and SW1-4 determine the amount of RAM installed on the system board.)
SW1-4	*	
SW1-5	*	Determines display type.
SW1-6	*	Determines display type.
SW1-7	*	(SW1-7 and SW1-8 determine the number of disk drive(s) installed to the system unit.)
SW1-8	*	

# Configuración switches XT

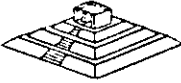

## 2) SW2 -- DIP Switch Two

<u>Switch No.</u>	<u>Default Setting</u>	<u>Function</u>
SW2-1		Reserved.
SW2-2		Reserved.
SW2-3		Reserved.
SW2-4		Reserved.
SW2-5		Reserved.
SW2-6	*	Determines the maximum amount of RAM which can be installed to the system board without using a memory expansion adapter.
SW2-7	ON	Enables the built-in RS-232C port.
SW2-8	ON	Enables the built-in parallel port.

apuntes



# Configuración switches XT



## A.5 Quick reference for Switch Settings involved with the memory size

SW2-6 ON - indicates the 640KB version.  
OFF - indicates the 256KB version.

SW1-3	SW1-4	Enabled Bank	256K Version	640K Version
ON	ON	1	64K	256K
OFF	ON	1,2	128K	512K
ON	OFF	1,2,3	192K	576K
OFF	OFF	1,2,3,4	256K	640K

apuntes

# Configuración switches AT



## Quick Guide

■ ON (or closed) □ OFF (or open)

FUNCTION SELECTION	SW1				SW2				SW3				SW4		JP1
	1	2	3	4	1	2	3	4	1	2	3	4	COLOR	MONO	
RAM SIZE	256KB				<input checked="" type="checkbox"/>	<input checked="" type="checkbox"/>									
	512KB					<input checked="" type="checkbox"/>	<input checked="" type="checkbox"/>								
	640KB						<input checked="" type="checkbox"/>	<input checked="" type="checkbox"/>							
	768KB							<input checked="" type="checkbox"/>							
DISPLAY TYPE	DISABLE														COLOR
	COLOR														COLOR
	MONO-CRIME														MONO
SYSTEM SPEED	HIGH SPEED (10 MHz)														
	LOW SPEED (4.77 MHz)														
	DISK DRIVE														
DRIVE NUMBER	1 DISK DRIVE														
	2 DISK DRIVE														
IDE1	ENABLE														
	DISABLE														
COM1	ENABLE														
	DISABLE														
COM2	ENABLE														
	DISABLE														
CURRENT SETTING															

\* RTC BANK WINDOW ADDRESS ON BOARD DISPLAY DISABLE | please refer to manual for

## Switch Position

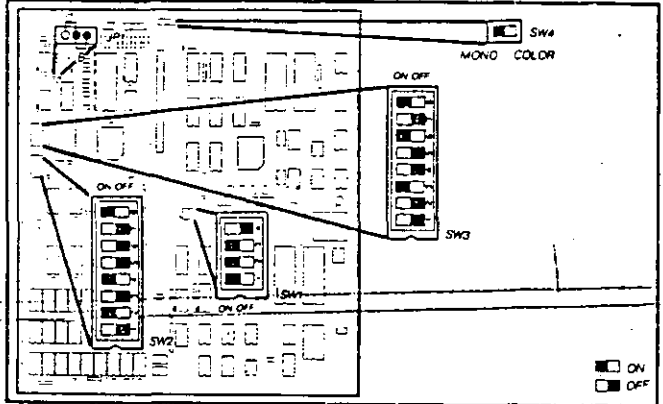

40.71003.011

apuntes

# Configuración switches AT



## SW1 - SWITCH ONE

Switch No.	Setting	Function
SW1-1	OFF	Disable COM1
	ON (DEFAULT)	Enable COM1
SW1-2	OFF	Disable COM2
	ON (DEFAULT)	Enable COM2
SW1-3	OFF	Enable real time clock (RTC1)
	ON (DEFAULT)	Enable real time clock (RTC0)
SW1-4	OFF (DEFAULT)	Disable IRQ2
	ON	Enable IRQ2

apuntes

# Que es un jumper ?

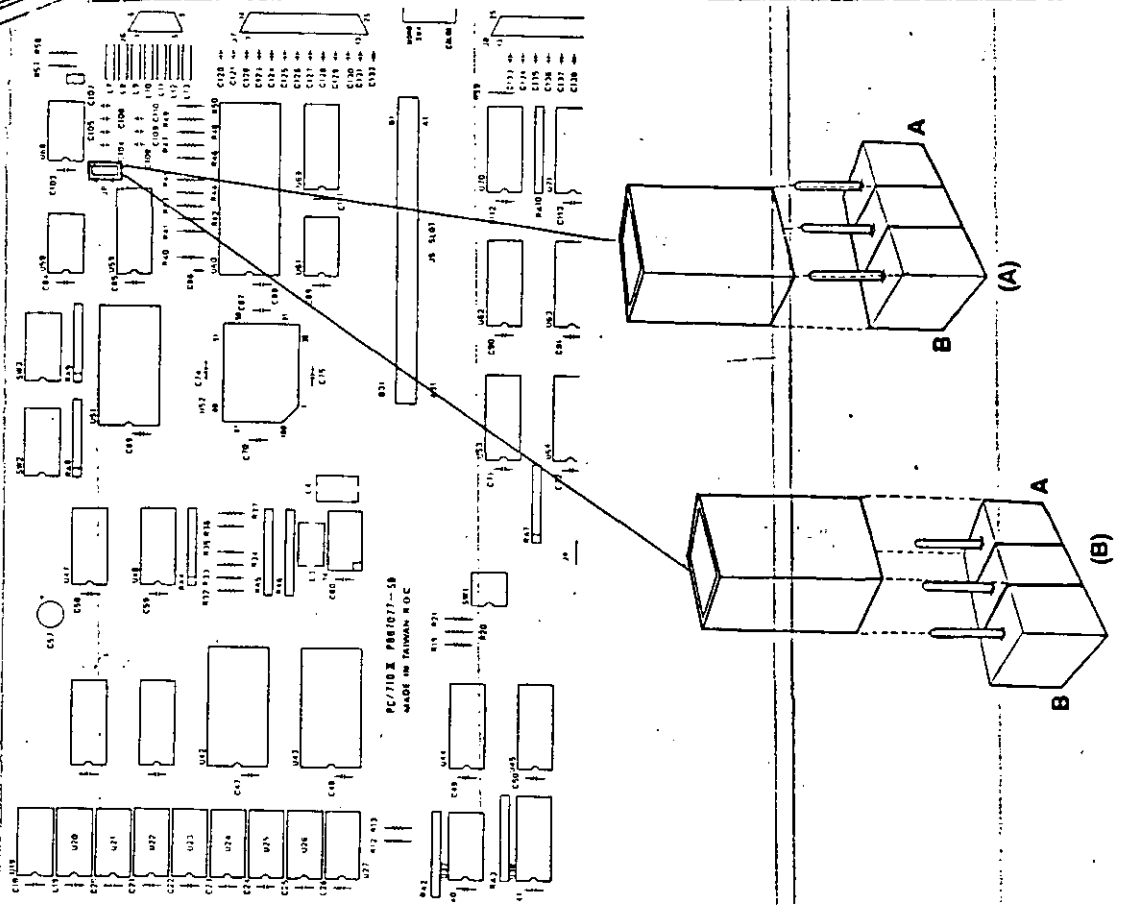

apuntes

# Jumpers AT



## JUMPER SETTING FOR DISPLAY AT JP1

The built-in display interface supports flicker free scrolling for the following display types:

- IBM monochrome compatibility
- IBM color graphics compatibility
- Hercules monochrome graphics compatibility
- Plantronics color plus compatibility

You may enable or disable the built-in display adapter by setting the JP1 jumper.

When using EGA card, the built-in display interface should be disabled by closing jumper JP1 at position A and setting SW2-6 to ON. The slide switch SW4 must be set to COLOR or MONOCHROME respectively when using color or monochrome monitor. Set SW4 to color if EGA mode is used.

apuntes

# Configuración switches AT



Refer to the table on the floppy disk driver bracket. Adjacent to 768 KB and under SW2 you will see two small rectangles. The rectangles indicate how the switches are set. The third switch on switch block SW2 (SW2-3), and the fifth switch on switch block SW3 (SW3-5) are both set to OFF; and the fourth switch on the switch block SW2 (SW2-4), and the sixth switch on switch block SW3 (SW3-6) are both set to ON.

Again referring to the table, the two diskette drive configuration requires you to set the switches SW2-1, SW2-7 and SW2-8 to OFF, OFF and ON respectively.

## apuntes

[Empty section for notes]

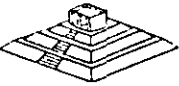

2.- REBASO DE LA PARTE 1

# BIOS AMERICAN MEGATRENDS



CMOS SETUP (C) Copyright 1985-1989, American Megatrends Inc.,

Date (mn/date/year) : Wed, Mar 15 1989  
 Time (hour/min/sec) : 13 : 29 : 34  
 Floppy drive A: : 1.44 MB, 3 1/2"  
 Floppy drive B: : 1.2 MB, 5 1/4"

Base memory size : 640 KB  
 Ext. memory size : 384 KB  
 Numeric processor : Not installed

Hard disk C: type : 47 = USER TYPE      Cyln Head WPcom LZone Sec Size  
 1224 16 1224 1224 36 330 MB  
 Hard disk D: type : 40                      820 6 820 820 17 42MB  
 Primary display : VGA or EGA  
 Keyboard : Installed

Scratch RAM option : 1

Sun	Mon	Tue	Wed	Thu	Fri	Sat
26	27	28	1	2	3	4
5	6	7	8	9	10	11
12	13	14	15	16	17	18
19	20	21	22	23	24	25
26	27	28	29	30	31	1
2	3	4	5	6	7	8

FIXED type = 01....46, USER defined type = 47  
 For type 47 Enter: Cyln,Head,WPcom,LZone,Sec,  
 (WPcom is 0 for ALL, 65535 for NONE)

ESC = Exit, ↓ ← ↑ → = Select, PgUp/PgDn = Modify

apuntes



# BIOS AMERICAN MEGATRENDS



Use the ↓ ← ↑ → keys to highlight the parameters you want to change.  
Use the <PgUp> and <PgDn> keys to modify the values.

## Date and Time

Use the ↓ ← ↑ → keys to select the parameters you want to change.  
Use the <PgUp> and <PgDn> keys to cycle through the available settings.

## Floppy Disk Drives

Select the Floppy drive field. Press the <PgUp> and <PgDn> keys to cycle through the available settings. Available floppy disk drives are 5 1/4" (360KB, 1.2MB) and 3 1/2" (720KB, 1.44MB). If your system does not have a floppy drive B, be certain to specify "Not installed".

## Primary Display

Select the Primary display field to establish the primary video display adapter type. Press the <PgUp> and <PgDn> keys to cycle through the available settings:

- Monochrome (Monochrome adapter, including MDA and Hercules)
- Color 40x25 (Color Graphics Adapter initialized in 40-column mode).
- EGA (Enhanced Graphics Adapter) or VGA (Video Graphic Array).
- Color 80x25 (Color Graphics Adapter initialized in 80-column mode).

apuntes

# BIOS AMERICAN MEGATRENDS



### Hard Disk Drives

For hard disk drives, use the <PgUp> and <PgDn> keys to cycle through the 46 types of disk drives supported. Type 47 is given to help the user defined its own drive type which will be stored in the CMOS. See Table 3.2 for a printed list of these drive types.

### Bypassing Keyboard Error

To configure the system for non dedicated file servers, you can set the keyboard "Not installed" in the SETUP menu so that BIOS will not report any "Keyboard error" and will not wait for "F1" key to be pressed during system boot.

apuntes

# BIOS AMERICAN MEGATRENDS



## Bypassing Video Error

To configure the system for non dedicated file servers, you can set the video "Not installed" in the SETUP menu if you do not have a display connected. The BIOS will not report any "Video error" and will not wait for any "F1" key to be pressed during system boot.

## Bypassing Floppy Error

To configure the system without floppy controller, you can set both the BIOS supported floppy drives (A and B) as "Not installed". In that case BIOS will not check for the floppy controller and will not report any error.

After you have finished with the SETUP program, press the < Esc > key. A prompt will then appear:

Write data into CMOS and exit (Y/N)

Type "Y" and press the < Enter > key. The computer performs a cold boot (equivalent to turning the power off and back again), followed by memory test, and then tries to boot from the disk drive. If your hard disk has not yet been initialized, be sure that you have a bootable DOS diskette.

# BIOS AMERICAN MEGATRENDS



Table 3.2 Supported Hard Disk Drives

Type	Cylinders	Heads	Write Precomp	Landing Zone	Capacity
1	306	4	128	305	10MB
2	615	4	300	615	20MB
3	615	6	300	615	31MB
4	940	8	512	940	62MB
5	940	6	512	940	47MB
6	615	4	None	615	20MB
7	462	8	256	511	31MB
8	733	5	None	733	30MB
9	900	15	None	901	112MB
10	820	3	None	820	20MB
11	855	5	None	855	35MB
12	855	7	None	855	50MB
13	306	8	128	319	20MB
14	733	7	None	733	43MB
15	Reserved				
16	612	4	All	663	20MB
17	997	5	300	977	41MB
18	977	7	None	997	57MB
19	1024	7	512	1023	60MB
20	733	5	300	732	30MB
21	733	7	300	732	43MB
22	733	5	300	733	30MB
23	306	4	All	336	10MB
24	925	7	All	925	54MB
25	925	9	None	925	69MB
26	754	7	754	754	44MB
27	754	11	None	754	69MB
28	699	7	256	699	41MB
29	823	10	None	823	68MB
30	918	7	918	918	53MB
31	1024	11	None	1024	94MB
32	1024	15	None	1024	128MB

Continue on next page ...

apuntes

# BIOS AMERICAN MEGATRENDS



Table 3.2 Supported Hard Disk Drives

Type	Cylinders	Heads	Write Precomp	Landing Zone	Capacity
33	1024	5	1024	1024	43MB
34	612	2	128	612	10MB
35	1024	9	None	1024	77MB
36	1024	8	512	1024	68MB
37	615	8	128	615	41MB
38	987	3	987	987	25MB
39	987	7	987	987	57MB
40	820	6	820	820	41MB
41	977	5	977	977	41MB
42	981	5	981	981	41MB
43	830	7	512	830	48MB
44	830	10	None	830	69MB
45	917	15	None	918	114MB
46	1224	15	None	1223	152MB

apuntes

# BIOS AWARD



The SETUP program lets you specify your system's configuration of diskette drives, hard disk drives, video display, memory, date and time. The SETUP program is built-in, you do not need a diskette to use it.

### Note

The following procedures assume your system has the Award 286 Modular BIOS installed. If your system has a different BIOS installed, these procedures will not work.

To run SETUP program, simultaneously press the < Ctrl > < Alt > < Esc > keys. The SETUP screen appears on your display:

AWARD SOFTWARE CMOS SETUP					
DATE (MM/DD/YY)	6/15/89*				
TIME (HH:MM:SS)	11:08:14				
DISKETTE 1	1.2M				
DISKETTE 2	360K				
DISK 1	22	CYLS 733	HEADS 5	SECTORS 17	PRECOME 300
DISK 2	NONE				
VIDEO	EGA				
BASE MEMORY	512				
EXTENDED MEMORY	0				
ERROR HALT	NO DISK ERROR HALT				
SPEED SELECT	NO CHANGE				

↓ ↑ moves between items, ← → selects values  
F10 records changes, F1 exits, F2 for color toggle

apuntes

Table 3.3 Supported Hard Disk Drives

Type	Cylinders	Heads	Write Precomp	Landing Zone	Specific Disk
0	306	4	128	305	
1	615	4	300	615	Seagate 225
2	615	6	300	615	
3	940	8	512	940	
4	940	6	512	940	
5	615	4	0	615	
6	462	8	256	511	
7	733	5	0	733	Seagate 4038
8	900	15	0	901	
9	820	3	0	820	
10	855	5	0	855	
11	855	7	0	855	
12	855	7	0	855	
13	306	8	128	319	Seagate 225
14	733	7	0	733	
15	Reserved				
16	612	4	0	663	
17	997	5	300	997	
18	997	7	0	997	
19	1024	7	512	1023	
20	733	5	300	732	
21	733	7	300	732	
22	733	5	300	733	Seagate 4038
23	306	4	0	336	
24	Reserved				
25	1024	9	0	1023	Seagate 4096
26	1224	7	0	1223	Maxtor 2085
27	1224	11	0	1223	Maxtor 2140
28	1224	15	0	1223	Maxtor 2190
29	1024	8	0	1023	Maxtor 1085
30	1024	11	0	1023	Maxtor 1105
31	918	11	0	1023	Maxtor 1170

Continue on next page ...

BIOS AWARD

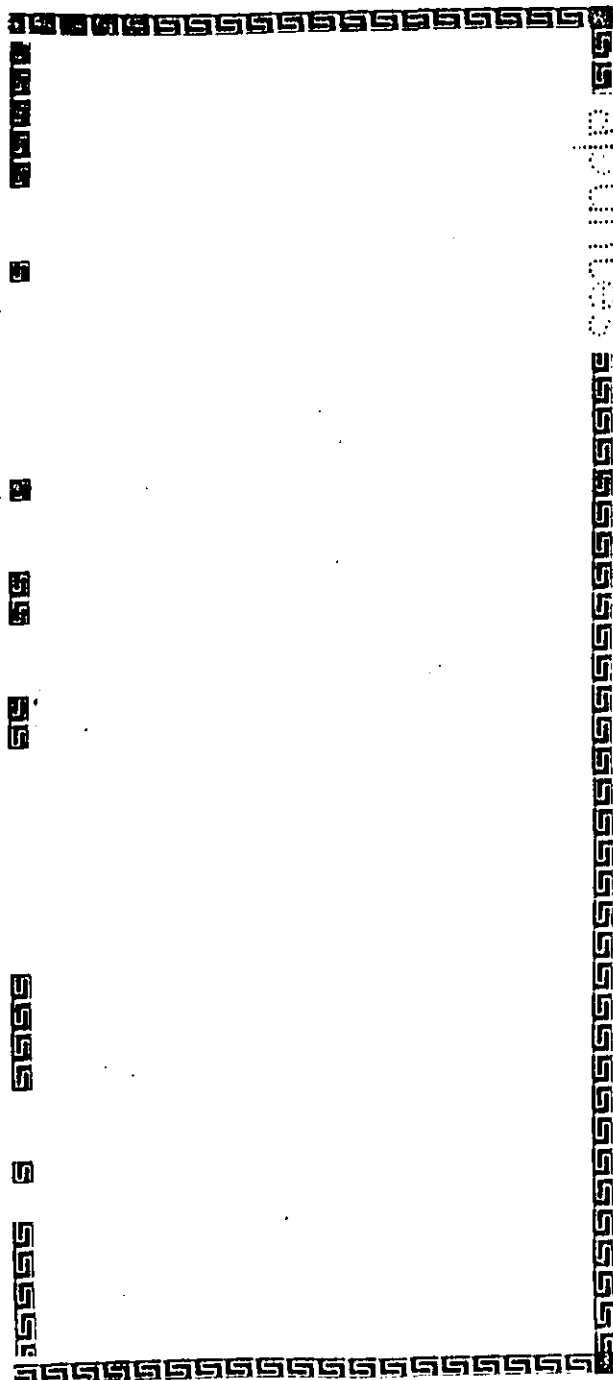

apures

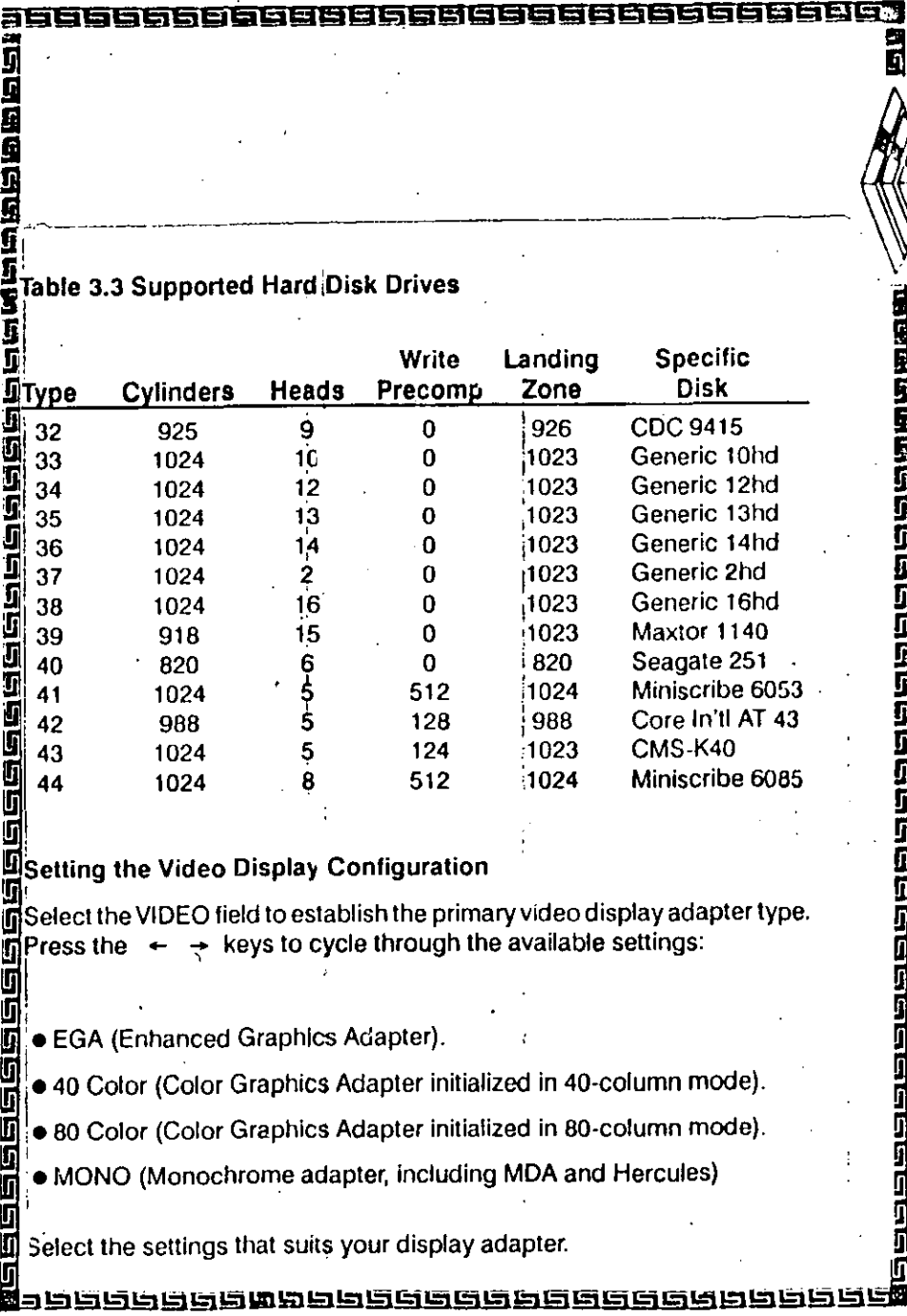

Table 3.3 Supported Hard Disk Drives

Type	Cylinders	Heads	Write Precomp	Landing Zone	Specific Disk
32	925	9	0	926	CDC 9415
33	1024	10	0	1023	Generic 10hd
34	1024	12	0	1023	Generic 12hd
35	1024	13	0	1023	Generic 13hd
36	1024	14	0	1023	Generic 14hd
37	1024	2	0	1023	Generic 2hd
38	1024	16	0	1023	Generic 16hd
39	918	15	0	1023	Maxtor 1140
40	820	6	0	820	Seagate 251
41	1024	5	512	1024	Miniscribe 6053
42	988	5	128	988	Core In'tl AT 43
43	1024	5	124	1023	CMS-K40
44	1024	8	512	1024	Miniscribe 6085

Setting the Video Display Configuration

Select the VIDEO field to establish the primary video display adapter type. Press the ← → keys to cycle through the available settings:

- EGA (Enhanced Graphics Adapter).
- 40 Color (Color Graphics Adapter initialized in 40-column mode).
- 80 Color (Color Graphics Adapter initialized in 80-column mode).
- MONO (Monochrome adapter, including MDA and Hercules)

Select the settings that suits your display adapter.





# Registros de Reloj



## D.4 Real-Time CLock Information

(Addresses 00-0D)

Byte	Function	Address
0	Seconds	00
1	Second alarm	01
2	Minutes	02
3	Minute alarm	03
4	Hours	04
5	Hour alarm	05
6	Day of week	06
7	Date of month	07
8	Month	08
9	Year	09
10	Status register A	0A
11	Status register B	0B
12	Status register C	0C
13	Status register D	0D

apuntes



3- HERRAMIENTAS DE DIAGNOSTICO

# PROGRAMAS DE DIAGNOSTICO

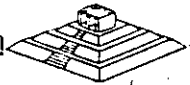

Serial Number: 00-000000

COPYRIGHT (c) 1990, 1991 TouchStone Software Corporation  
COPYRIGHT (c) 1989, 1990 Diagsoft, Inc.  
ALL RIGHTS RESERVED.

Press Any Key to Continue

apuntes

# PROGRAMAS DE DIAGNOSTICO



CheckIt 2.1

LOADING

INVESTIGATING SYSTEM CONFIGURATION.

Local	↓	Check for Remote Operation
AMI	↓	Identify BIOS Manufacturer
Complete	↓	Determine System Components
Complete	↓	Look for RAM (Base, Extended, Expanded)
Not Present	↓	Look for Math Co-processor
Not Present	↓	Look for Mouse

System Configuration Checks Complete.

Press Any Key to Continue

apuntes

# PROGRAMAS DE DIAGNOSTICO

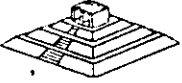

— CheckIt 3.20 —

SysInfo   Tests   Benchmarks   Tools   Setup   Exit

Configuration  
Interrupts  
CMOS Table  
Device Drivers

Displays information about the hardware and firmware on this PC.

Use Arrows to Point • Return to Select • F1 - Help • ESC - Cancel

apuntes

# PROGRAMAS DE DIAGNOSTICO

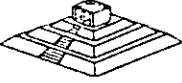

CheckIt 3.20

SysInfo Tests Benchmarks Tools Setup Exit

Configuration Information

DOS Version: 3.31

ROM BIOS: Unknown

BIOS Date: Unknown

Processor Type: 80286 XT Machine

Math Coprocessor: Not Present

Base Memory: 640K

Largest Free Block: 200K

Extended Memory: None

EXPANDED Memory: None

Video Adapter: CGA

Video Address: 8000h

Video RAM Size: 16K

Hard Drive(s): Drive 0 (C:) = 33M

Floppy Drive(s): A:Present

Clock/Calendar: None

Parallel Port(s): LPT1=3BCh, LPT2=378h

Serial Port(s): COM1=3F8h

Joystick(s): None

Mouse: None

F2 - Copy to Activity Log • Press Any Other Key to Continue

apuntes

# PROGRAMAS DE DIAGNOSTICO

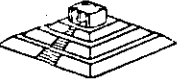

CheckIt 2.1

SysInfo	Tests	Benchmarks	Tools	Setup	Exit
---------	-------	------------	-------	-------	------

Configuration Information

DOS Version: 3.31

ROM BIOS: AMI

BIOS Date: 04/09/90

Processor Type: 80386 AT Machine

Math Coprocessor: Not Present

Base Memory: 640K

Available: 436K

Extended Memory: 1024K

Available: 0K

EXPANDED Memory: No EMS driver installed

Video Adapter: EGA

EGA Switches: 0110

Video Address: A000h

Video RAM Size: 256K

Hard Drive(s): Drive 0 (Non-DOS) = 43M

Floppy Drive(s): A:1.2M(5"), B:1.44M(3 1/2")

Clock/Calendar: CMOS Clock

Parallel Port(s): LPT1=3BCh, LPT2=278h

Serial Port(s): COM1=3F8h, COM2=2F8h

Mouse: None

Joystick(s): None

F2 - Copy to Activity Log • Press Any Other Key to Continue

apuntes

# PROGRAMAS DE DIAGNOSTICO

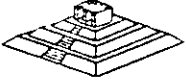

CheckJit 3.20

Sysinfo   Tests   Benchmarks   Tools   Setup   Exit

Configuration  
Interrupts  
CMOS Table  
Device Drivers

Displays information about the hardware and firmware on this PC.

Use Arrows to Point • Return to Select • F1 - Help • ESC - Cancel

apuntes



# PROGRAMAS DE DIAGNOSTICO

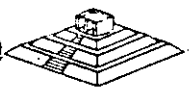

— CheckJit 3.20 —

<u>SysInfo</u>	Tests	Benchmarks	Tools	Setup	Exit
----------------	-------	------------	-------	-------	------

Interrupt Usage

INTERRUPT ASSIGNMENTS:

- IRQ 0 System Timer,SK
- IRQ 1 Keyboard,SK
- IRQ 2 Available
- IRQ 3 Available
- IRQ 4 COM1
- IRQ 5 Hard Disk
- IRQ 6 Floppy Disk
- IRQ 7 LPT1,LPT2

DEVICES WITH NO IRQ

None

STANDARD DMA ASSIGNMENTS:

- DMA 0 RAM Refresh
- DMA 1
- DMA 2 Floppy Disk
- DMA 3 Fixed Disk

---

F2 - Copy to Activity Log • Press Any Other Key to Continue

apuntes

# PROGRAMAS DE DIAGNOSTICO

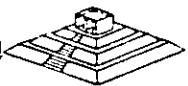

CheckIt 2.1

SysInfo Tests Benchmarks Tools Setup Exit

Interrupt Usage

INTERRUPT ASSIGNMENTS:

- IRQ 0 System Timer,SK
- IRQ 1 Keyboard,SK
- IRQ 2 [Cascade]
- IRQ 3 COM2,NET\$OS
- IRQ 4 COM1
- IRQ 5 Available
- IRQ 6 Floppy Disk
- IRQ 7 LPT1
- IRQ 8 Clock/Calendar
- IRQ 9 Available
- IRQ 10 Available
- IRQ 11 Available
- IRQ 12 Available
- IRQ 13 Reserved for NPU
- IRQ 14 Hard Disk
- IRQ 15 NET\$OS

DEVICES WITH NO IRQ  
LPT2

STANDARD DMA ASSIGNMENTS:

- DMA 0
- DMA 1
- DMA 2 Floppy Disk
- DMA 3
- DMA 4 [Cascade]
- DMA 5
- DMA 6
- DMA 7

F2 - Copy to Activity Log • Press Any Other Key to Continue

apuntes

# PROGRAMAS DE DIAGNOSTICO

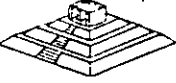

CheckJit 2.1

SysInfo Tests Benchmarks Tools Setup Exit

Configuration  
Interrupts  
CMOS Table  
Device Drivers

Displays the current settings of the non-volatile CMOS setup memory, if present.

Use Arrows to Point • Return to Select • F1 - Help • ESC - Cancel

apuntes

# PROGRAMAS DE DIAGNOSTICO

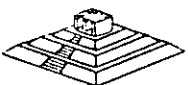

CheckIt 2.1

SysInfo Tests Benchmarks Tools Setup Exit

Display CMOS Table

Current Date & Time: 11/01/1990 18:34:49

Floppy Drive A: 1.2M(5¼")  
Floppy Drive B: 1.44M(3½")

Base Memory Size: 640K  
Extended Memory Size: 1024K

Primary Display: EGA, PGA, VGA, etc.

DRIVE TYPE	CYLS	HEADS	SECTS	WRITE PRECOMP	PARK PLACE	STEP RATE	CTRL BYTE	TOTAL BYTES
0:	40	820	6	17	820	820	0	42,823,680
1:	0	No Drive. ESDI Drive, or SCSI Drive.						

F2 - Copy to Activity Log • Press Any Other Key to Continue

apuntes

# PROGRAMAS DE DIAGNOSTICO

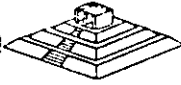

CheckIt 2.1

Sysinfo	<u>T</u> ests	Benchmarks	Tools	Setup	Exit
---------	---------------	------------	-------	-------	------

Test Everything

Memory

Hard Disk

Floppy Disk

System Board

Real-Time Clock

Serial Ports

Parallel Ports

Printers

Video

Input Devices

Select Batch...

---

Tests the random access memory on the PC.

---

Use Arrows to Point • Return to Select • F1 - Help • ESC - Cancel

apuntes

# PROGRAMAS DE DIAGNOSTICO



## Memory Test

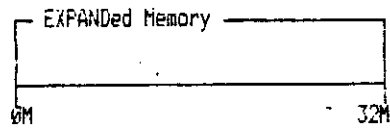
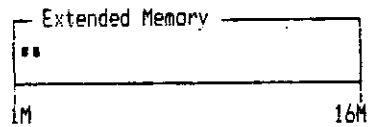
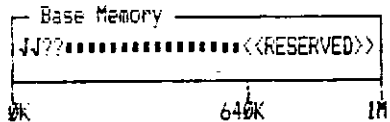

Passed  Test Program Buffers  
 Test Base Memory  
 Test Extended Memory  
 Test EXPANDED Memory

Will Test: 0000000h to 009FFFFh  
Now Testing: 0010000h to 001FFFFh

Using: Pseudo-Random Test

Quick Memory Test Only: Y

Number of Test Passes: 1

Total: 640K Base + 1.000M Extended + 0K EXPANDED ( 1.625M in all).  
Testing: 640K Base + 1.000M Extended + 0K EXPANDED ( 1.625M in all).

ESC - Interrupt (Might Not Be Immediate)

apuntes

# PROGRAMAS DE DIAGNOSTICO

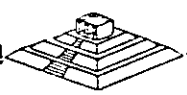

## System Board Test

- Passed  CPU General Functions
- Passed  CPU Interrupt Bug
- Passed  CPU 32-bit Multiply Bug (80386 only)
- Passed  CPU Protected Mode (80286 and 80386 only)
- Skipped  NPU Arithmetic Functions
- Skipped  NPU Trigonometric Functions
- Skipped  NPU Comparison Functions
- Passed  DMA Controller(s)
- Passed  Interrupt Controller(s)

Press Any Key to Continue

apuntes





# PROGRAMAS DE DIAGNOSTICO

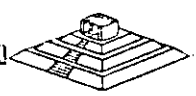

Hard Disk Test

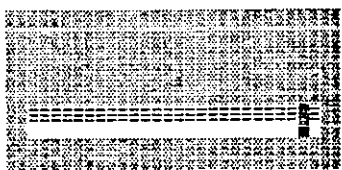

Drive: 0 (Non-DOS)  
 Cylinders: 819  
 Heads: 6  
 Sectors/Track: 17  
 Total Bytes: 42,771,456

Testing: Cyl 3, Head 2  
 To Go: 815

Passed	✓	Controller Diags	
Passed	✓	Linear Read	
Passed	✓	Butterfly Read	
Passed	✓	Random Read	

Errors

Cyl	Hd	Notes

Press Any Key to Continue

apuntes

# PROGRAMAS DE DIAGNOSTICO

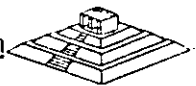

CheckIt 2.1

SysInfo   Tests   Benchmarks   Tools   Setup   Exit

Main System  
Hard Disk

Measures video speed, numerical calculation speed, and overall system performance.

Use Arrows to Point • Return to Select • F1 - Help • ESC - Cancel

apuntes

# PROGRAMAS DE DIAGNOSTICO

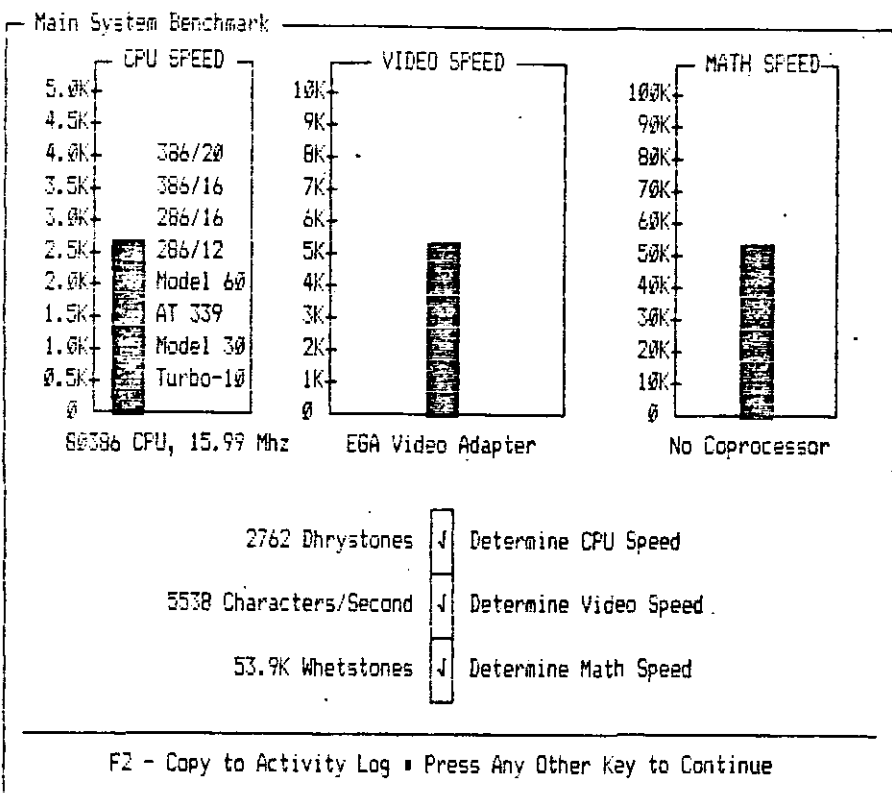
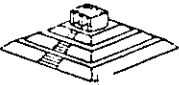

apuntes

# PROGRAMAS DE DIAGNOSTICO



CheckIt 2.1

SysInfo   Tests   Benchmarks   Tools   Setup   Exit

Color On/Off  
Activity Log  
RAM Layout

Used to describe this system's memory boards to CheckIt so that "Locate RAM Chips" can display pictures of them.

Use Arrows to Point • Return to Select • F1 - Help • ESC - Cancel

apuntes

# PROGRAMAS DE DIAGNOSTICO

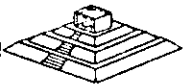

## RAM Layout

Sample Board	32 Bits:	640K Base	(Address 000000h to 009FFFFh)
		384K Extended	(Address 010000h to 015FFFFh)
Slot 1	16 Bits:	2.048M EXPANDED	(Address 000000h to 01FFFFFFh)
Slot 2	Undefined.		
Slot 3	Undefined.		
Slot 4	Undefined.		

Select Activity: C  
V-View C-Change D-Delete

-Select Board ESC-Cancel

apuntes

# PROGRAMAS DE DIAGNOSTICO

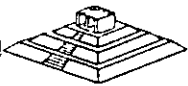

RAM Layout

Sample Board	Name: Sample Board	Word Size: 32 Bits																									
Slot 1	Bank 0 on Top? Y	Parity on Right? Y																									
Slot 2	<table border="1"> <thead> <tr> <th>RAM Chips:</th> <th>Bank Size</th> <th>Bank Size</th> <th>Bank Size</th> <th>Bank Size</th> </tr> </thead> <tbody> <tr> <td>0</td> <td>256K</td> <td>4 None</td> <td>8 None</td> <td>12 None</td> </tr> <tr> <td>1</td> <td>256K</td> <td>5 None</td> <td>9 None</td> <td>13 None</td> </tr> <tr> <td>2</td> <td>None</td> <td>6 None</td> <td>10 None</td> <td>14 None</td> </tr> <tr> <td>3</td> <td>None</td> <td>7 None</td> <td>11 None</td> <td>15 None</td> </tr> </tbody> </table>		RAM Chips:	Bank Size	Bank Size	Bank Size	Bank Size	0	256K	4 None	8 None	12 None	1	256K	5 None	9 None	13 None	2	None	6 None	10 None	14 None	3	None	7 None	11 None	15 None
RAM Chips:	Bank Size	Bank Size	Bank Size	Bank Size																							
0	256K	4 None	8 None	12 None																							
1	256K	5 None	9 None	13 None																							
2	None	6 None	10 None	14 None																							
3	None	7 None	11 None	15 None																							
Slot 3	Base? Y	Amount: 640K	Start: 0K (000000h)																								
Slot 4	Extended? Y	Amount: 384K	Start: 1.000M (100000h)																								
	EXPANDED? N	Amount:	Start: ( h)																								
Total RAM on Board: 2.000M																											

Enter a name to identify the board you are modifying.

- Select Field - ESC - Cancel

apuntes

# PROGRAMAS DE DIAGNOSTICO

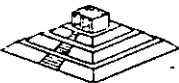

CheckNIt 2.1

SysInfo   Tests   Benchmarks   Tools   Setup   Exit

Locate RAM Chips  
Set Real-Time Clock  
Hard Disk Formatter

After a memory test, can be used to display a picture of the system's memory boards showing the chip or chips that need replacing.

Use Arrows to Point ■ Return to Select ■ F1 - Help ■ ESC - Cancel

apuntes

# PROGRAMAS DE DIAGNOSTICO



## Locate RAM Chips

### Sample Board

Bank 0	0	1	2	3	4	5	6	7 => P	256K
	8	9	10	11	12	13	14	15 => P	256K
	16 => 17	18	19	20 => 21	22	23 => P	256K		
	24	25	26	27	28	29	30	31 => P	256K
				MORE					

### 32 Bit Words

640K Base (Address 000000h to 009FFFFh)  
 384K Extended (Address 010000h to 015FFFFh)

This is the memory layout for the motherboard.

- View Board • F2 - Copy to Activity Log • ESC - Cancel

apuntes



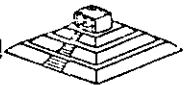

MICROCONTROLADORES PRINCIPALES  
Y SISTEMAS MINIMOS

# Sistemas Mínimos

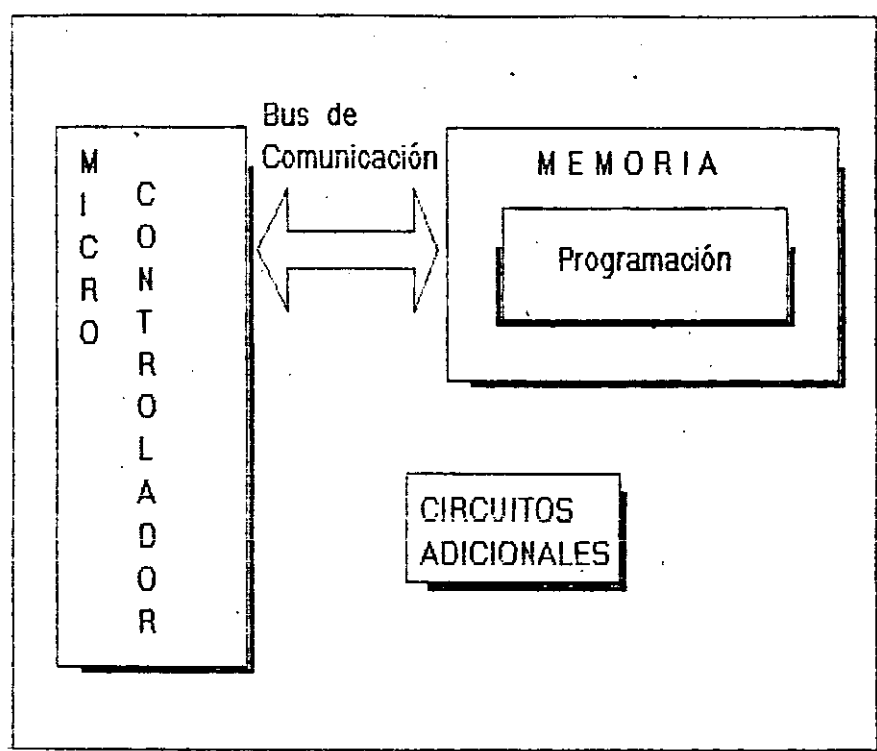
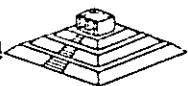

apuntes

# Microcontroladores Principales y Sistemas Mínimos

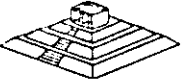

Generador de Reloj: 82284 - 82384 - 8284

Controlador de DMA: 8257 - 8237

Controlador de  
Periféricos Programable: 8255

Controlador de  
Unidades de Disco: 82064 - 82062

Controlador de Teclado: 8040 - 8248

Controlador de  
Interrupciones Programable: 8259

Controlador de Puerto Serie: 8250

Controlador Programable  
de "Interval Timer:" 8253



apuntes

apures  
seque

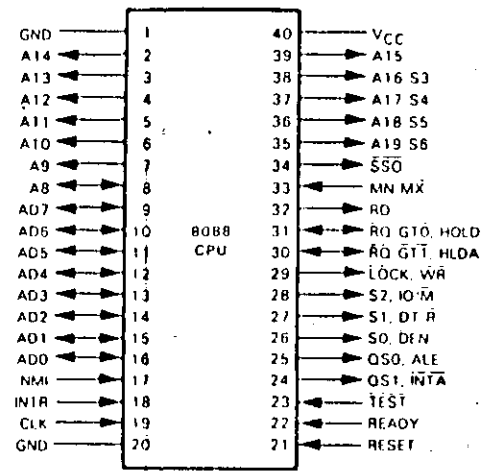

Pin Name	Description	Type
AD0-AD7	Address Data Bus	Bidirectional, tristate
A8-A15	Address Bus	Output, tristate
A16-S3, A17-S4	Address Segment Identifier	Output, tristate
A18-S5	Address Interrupt enable status	Output, tristate
A19-S6	Address status	Output, tristate
SS0	Status output	Output, tristate
RO	Read control	Output, tristate
READY	Wait state request	Input
TEST	Wait for test control	Input
INTR	Interrupt request	Input
NMI	Non-maskable interrupt request	Input
RESET	System Reset	Input
CLK	System Clock	Input
MN-MX	= GND for a maximum system	
S0, S1, S2	Machine cycle status	Output, tristate
RO GT0, RO GT1	Local bus priority control	Bidirectional
OS0, OS1	Instruction queue status	Output
LOCK	Bus hold control	Output, tristate
MN-MX	= VCC for a minimum system	
IO M	Memory or I/O access	Output, tristate
WR	Write control	Output, tristate
ALE	Address Latch enable	Output
DT R	Data transmit/receive	Output, tristate
DEN	Data enable	Output, tristate
INTA	Interrupt acknowledge	Output, tristate
HOLD	Hold request	Input
HLOA	Hold acknowledge	Output
VCC	Power supply	

Maximum System Signals  
 Minimum System Signals

8088 Pin and Signal Assignments

8088 CPU

Opus 2000

Instruction	Object Code	Bytes	Clock Periods
CBW	98	1	2
CLC	F8	1	2
CLD	FC	1	2
CLI	FA	1	2
CMC	F5	1	2
CMP	ac, data 001110w kk ijl	2 or 3	4
CMP	mem/reg, data 10000sw mod 111 r/m {DISP} {DISP} kk ijl	3, 4, 5 or 6	reg 4 mem: 10 + EA
CMP	mem/reg1, mem/reg2 001110dw mod rrr r/m {DISP} {DISP}	2, 3 or 4	reg to reg 3 mem to reg: 9 + EA reg to mem: 9 + EA
CMPS	1010011w	1	22 9 + 22/repetition'
CWD	99	1	5
DAA	27	1	4
DAS	2F	1	4
DEC	mem/reg 111111w mod 001 r/m {DISP} {DISP}	2, 3 or 4	reg: 3 mem: 15 + EA
DEC	16-bit reg 01001rr	1	2
DIV	mem/reg 1111011w mod 110 r/m {DISP} {DISP}	2, 3 or 4	8-bit reg 80 - 90 16-bit reg 144 - 162 8-bit mem: (86 - 96) + EA 16-bit mem: (150 - 168) + EA
ESC	mem/reg 1101xxx mod xxx r/m {DISP} {DISP}	2, 3 or 4	mem: 8 + EA reg: 2
HLT	F4	1	2
IDIV	mem/reg 1111011w mod 111 r/m {DISP} {DISP}	2, 3 or 4	8-bit reg 101 - 112 16-bit reg: 165 - 184 8-bit mem: (107 - 118) + EA 16-bit mem: (171 - 190) + EA
IMUL	mem/reg 1111011w mod 101 r/m {DISP} {DISP}	2, 3 or 4	8-bit reg 80 - 98 16-bit reg 128 - 154 8-bit mem: (86 - 104) + EA 16-bit mem: (134 - 180) + EA
IN	ac, DX 1110110w	1	8
IN	ac, port 1110010w	2	10



0000 0000 CPU

opurtes

Instruction		Object Code	Bytes	Clock Periods
INC	mem/reg	1111111w mod 000 r/m (DISP) (DISP)	2, 3 or 4	reg: 3 mem: 15 + EA
INC	16-bit reg	01000rrr	1	2
INT		11001100*	1	52
		11001101	2	51
		type		
INTO		CE	1	interrupt: 53 no interrupt: 4
IRET		CF	1	24
JA	disp	77	2	4/No Branch
JNBE	disp	disp		16/Branch
JAE	disp	73	2	4/No Branch
JNB	disp	disp		16/Branch
JB	disp	72	2	4/No Branch
JNAE	disp	disp		8/Branch
JBE	disp	76	2	4/No Branch
JNA	disp	disp		16/Branch
JCXZ	disp	E3	2	6/No Branch
		disp		18/Branch
JE	disp	74	2	4/No Branch
JZ	disp	disp		16/Branch
JG	disp	7F	2	4/No Branch
JNLE	disp	disp		16/Branch
JGE	disp	7D	2	4/No Branch
JNL	disp	disp		16/Branch
JL	disp	7C	2	4/No Branch
JNGE	disp	disp		16/Branch
JLE	disp	7E	2	4/No Branch
JNG	disp	disp		16/Branch
JMP	addr	EA kk j hh 00	5	15
JMP	disp	EB disp	2	15
JMP	disp16	E9 kk j	3	15
JMP	mem	FF mod 101 r/m (DISP) (DISP)	2, 3 or 4	mem ptr: 32 24 + EA
JMP	mem/reg	FF mod 100 r/m (DISP) (DISP)	2, 3 or 4	reg ptr: 16 11 mem ptr: 16: 18 + EA
JNE	disp	75	2	4/No Branch
JNZ	disp	disp		16/Branch
JNO	disp	71	2	4/No Branch
		disp		16/Branch
JNP	disp	78	2	4/No Branch
JPO	disp	disp		16/Branch
JNS	disp	79	2	4/No Branch
		disp		16/Branch
JO	disp	70	2	4/No Branch
		disp		16/Branch

\*Implied type = 3

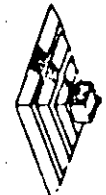

0000 0000

Instruction	Object Code	Bytes	Clock Periods
AAA	37	1	4
AAD	05 0A	2	60
AAM	04 0A	2	83
AAS	3F	1	4
ADC	ac.data 0001010w kk {j}	2 or 3	4
ADC	mem/reg1.data 100000sw mod 010 r/m {DISP} {DISP} kk {j}	3, 4, 5 or 6	reg 4  mem: 17 + EA
ADC	mem/reg1.mem/reg2 000100dw mod rrr r/m {DISP} {DISP}	2, 3 or 4	reg to reg 3 mem to reg: 8 + EA reg to mem: 16 + EA
ADD	ac.data 0000010w kk {j}	2 or 3	4
ADD	mem/reg.data 100000sw mod 000 r/m {DISP} {DISP} kk {j}	3, 4, 5 or 6	reg 4 mem 17 + EA
ADD	mem/reg1.mem/reg2 000000dw mod rrr r/m {DISP} {DISP}	2, 3 or 4	reg to reg 3 mem to reg: 9 + EA reg to mem: 16 + EA
AND	ac.data 0010010w kk {j}	2 or 3	4
AND	mem/reg.data 1000000w mod 100 r/m {DISP} {DISP} kk {j}	3, 4, 5 or 6	reg 4  mem: 17 + EA
AND	mem/reg1.mem/reg2 001000dw mod rrr r/m {DISP} {DISP}	2, 3 or 4	reg to reg 3 mem to reg 9 + EA reg to mem 16 + EA
CALL	addr 9A kk ü hh	5	28
CALL	disp16 EB kk ü	3	19
CALL	mem FF mod 011 r/m {DISP} {DISP}	2, 3 or 4	32-bit mem pointer: 37 + EA
CALL	mem/reg FF mod 110 r/m {DISP} {DISP}	2, 3, or 4	16-bit reg pointer: 16 16-bit mem pointer: 21 + EA



CPU 0088



**82284**  
**CLOCK GENERATOR AND READY INTERFACE**  
**FOR IAPX 286 PROCESSORS**  
 (82284-10, 82284-8, 82284-6)

- Generates System Clock for IAPX 286 Processors
- Uses Crystal or TTL Signal for Frequency Source
- Provides Local READY and MULTIBUS®\* READY Synchronization
- Available in 18-Lead Cerdip Package (See Packaging Spec, Order #231369)
- Single +5V Power Supply
- Generates System Reset Output from Schmitt Trigger Input
- Available in EXPRESS
  - Standard Temperature Range
  - Extended Temperature Range

The 82284 is a clock generator/driver which provides clock signals for IAPX 286 processors and support components. It also contains logic to supply READY to the CPU from either asynchronous or synchronous sources and synchronous RESET from an asynchronous input with hysteresis.

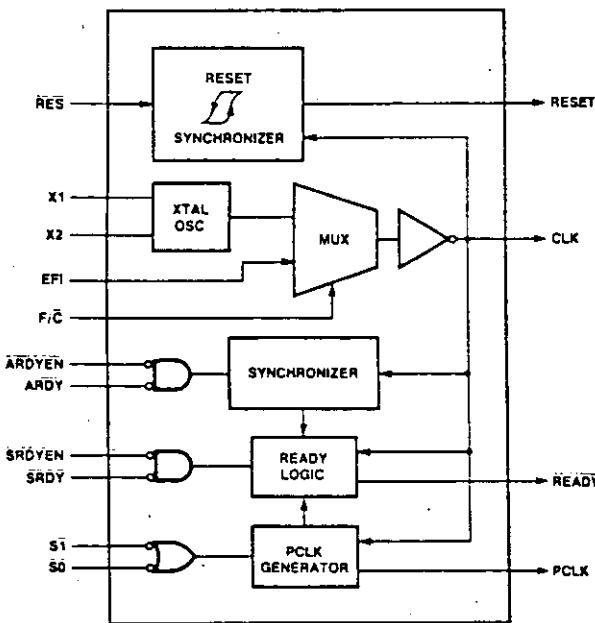

Figure 1. 82284 Block Diagram

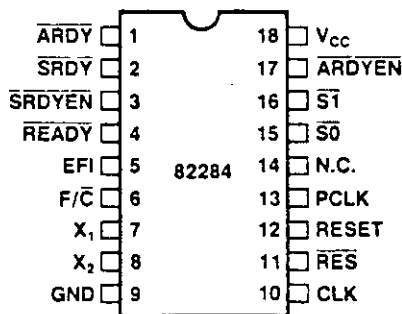

Figure 2.  
82284 Pin Configuration

\*MULTIBUS is a patented bus of Intel.

Intel Corporation Assumes No Responsibility for the Use of Any Circuitry Other Than Circuitry Embodied in an Intel Product. No Other Circuit Patent Licenses are Implied.





82284

Waveforms

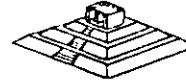

CLK as a Function of EFl (82284-6 only)

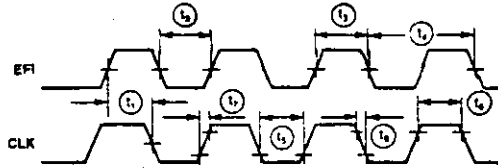

NOTE: The EFl input LOW and HIGH times as shown are required to guarantee the CLK LOW and HIGH times shown.

RESET and READY Timing as a Function of RES with S1, S0, ARDY to ARDYEN, and SRDY + SRDYEN HIGH

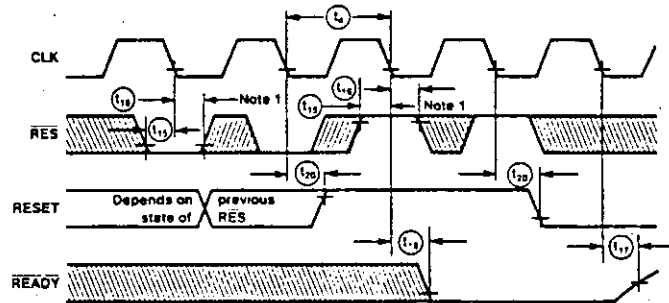

NOTE 1: This is an asynchronous input. The setup and hold times shown are required to guarantee the response shown.

READY and PCLK Timing with RES HIGH

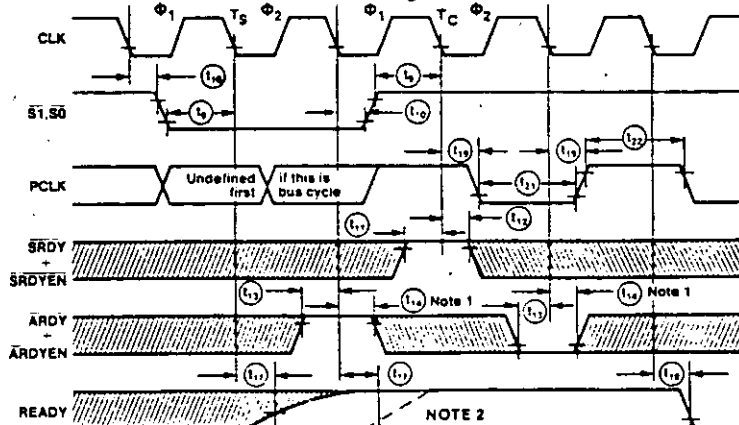

NOTE 1: This is an asynchronous input. The setup and hold times shown are required to guarantee the response shown.

NOTE 2: If SRDY + SRDYEN or ARDY - ARDYEN are active before and/or during the first bus cycle after RESET, READY may not be deasserted until after the falling edge of  $\Phi_2$  of  $T_S$ .

intel

82284

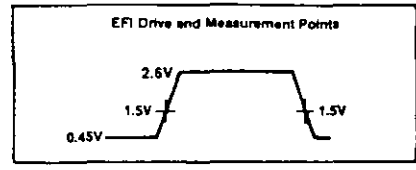

NOTE 9:

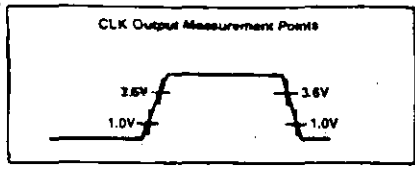

NOTE 10:

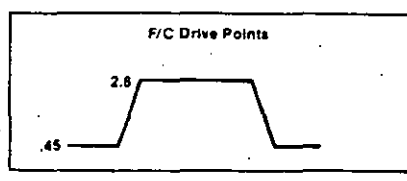

NOTE 11:

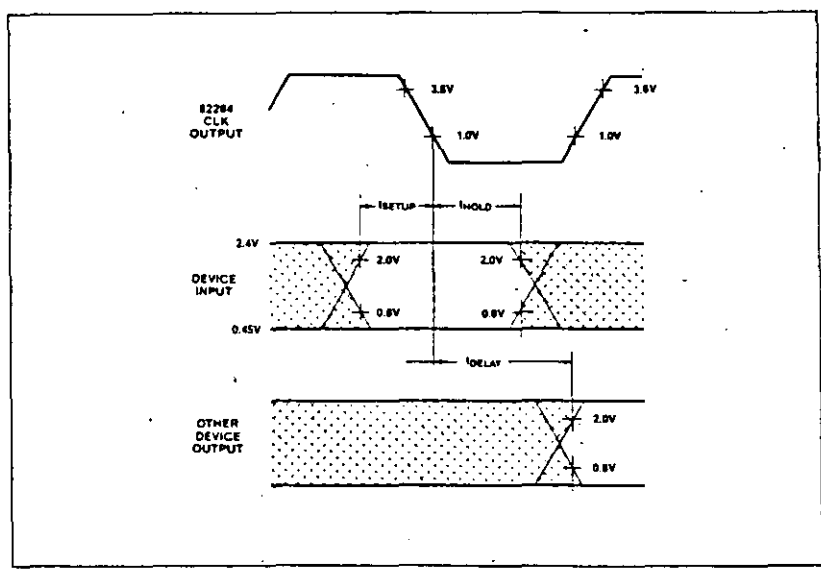

NOTE 12: AC Setup, Hold and Delay Time Measurement—General

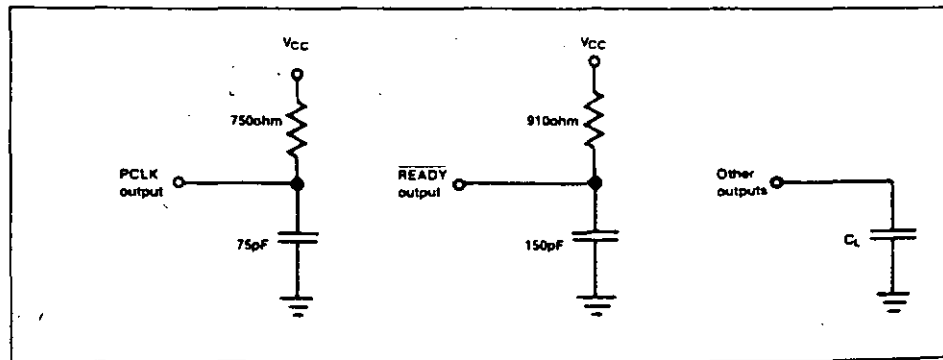

NOTE 13: AC Test Loading on Outputs



## 8284A/8284A-1 CLOCK GENERATOR AND DRIVER FOR IAPX 86, 88 PROCESSORS

- Generates the System Clock for the IAPX 86, 88 Processors:  
5 MHz, 8 MHz with 8284A  
10 MHz with 8284A-1
- Uses a Crystal or a TTL Signal for Frequency Source
- Provides Local READY and MULTIBUS® READY Synchronization
- 18-Pin Package
- Single +5V Power Supply
- Generates System Reset Output from Schmitt Trigger Input
- Capable of Clock Synchronization with Other 8284As
- Available in EXPRESS
  - Standard Temperature Range
  - Extended Temperature Range

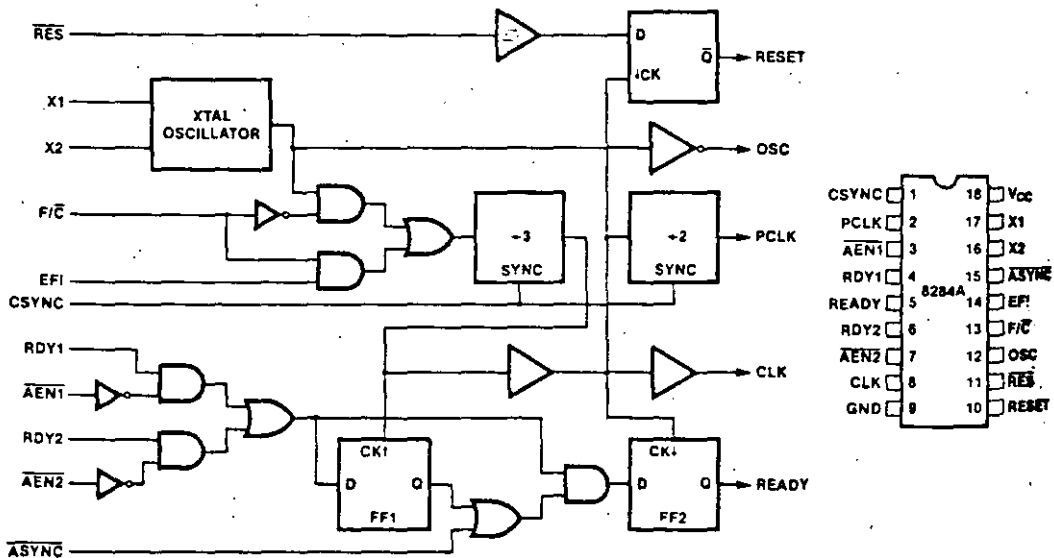

8284A/8284A-1 Block Diagram

8284A/8284A-1 Pin Configuration

3-246

GENERADOR DE RELOJ



## 8237A/8237A-4/8237A-5 HIGH PERFORMANCE PROGRAMMABLE DMA CONTROLLER

- Enable/Disable Control of Individual DMA Requests
- Four Independent DMA Channels
- Independent Autoinitialization of all Channels
- Memory-to-Memory Transfers
- Memory Block Initialization
- Address Increment or Decrement
- High performance: Transfers up to 1.6M Bytes/Second with 5 MHz 8237A-5
- Directly Expandable to any Number of Channels
- End of Process Input for Terminating Transfers
- Software DMA Requests
- Independent Polarity Control for DREQ and DACK Signals
- Available in EXPRESS - Standard Temperature Range
- Available in 40-Lead Cerdip and Plastic Packages  
(See Packaging Spec. Order #231369)

The 8237A Multimode Direct Memory Access (DMA) Controller is a peripheral interface circuit for microprocessor systems. It is designed to improve system performance by allowing external devices to directly transfer information from the system memory. Memory-to-memory transfer capability is also provided. The 8237A offers a wide variety of programmable control features to enhance data throughput and system optimization and to allow dynamic reconfiguration under program control.

The 8237A is designed to be used in conjunction with an external 8-bit address register such as the 8282. It contains four independent channels and may be expanded to any number of channels by cascading additional controller chips.

The three basic transfer modes allow programmability of the types of DMA service by the user. Each channel can be individually programmed to Autoinitialize to its original condition following an End of Process (EOP).

Each channel has a full 64K address and word count capability.

The 8237A-4 and 8237A-5 are 4 MHz and 5 MHz selected versions of the standard 3 MHz 8237A respectively.

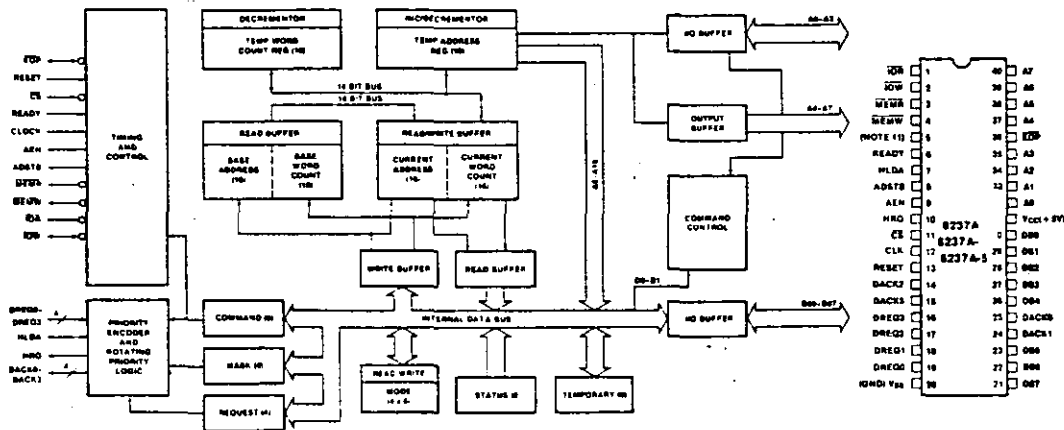

Figure 1. Block Diagram

Figure 2. Pin Configuration

Table 1. Pin Description

Symbol	Type	Name and Function
VCC		Power: +5 volt supply.
VSS		Ground: Ground.
CLK	I	<b>Clock Input:</b> Clock Input controls the internal operations of the 8237A and its rate of data transfers. The input may be driven at up to 3 MHz for the standard 8237A and up to 5 MHz for the 8237A-5.
CS	I	<b>Chip Select:</b> Chip Select is an active low input used to select the 8237A as an I/O device during the Idle cycle. This allows CPU communication on the data bus.
RESET	I	<b>Reset:</b> Reset is an active high input which clears the Command, Status, Request and Temporary registers. It also clears the first/last flip/flop and sets the Mask register. Following a Reset the device is in the Idle cycle.
READY	I	<b>Ready:</b> Ready is an input used to extend the memory read and write pulses from the 8237A to accommodate slow memories or I/O peripheral devices. Ready must not make transitions during its specified setup/hold time.
HLDA	I	<b>Hold Acknowledge:</b> The active high Hold Acknowledge from the CPU indicates that it has relinquished control of the system busses.
DREQ0-DREQ3	I	<b>DMA Request:</b> The DMA Request lines are individual asynchronous channel request inputs used by peripheral circuits to obtain DMA service. In fixed Priority, DREQ0 has the highest priority and DREQ3 has the lowest priority. A request is generated by activating the DREQ line of a channel. DACK will acknowledge the recognition of DREQ signal. Polarity of DREQ is programmable. Reset initializes these lines to active high. DREQ must be maintained until the corresponding DACK goes active.
DB0-DB7	I/O	<b>Data Bus:</b> The Data Bus lines are bidirectional three-state signals connected to the system data bus. The outputs are enabled in the Program condition during the I/O Read to output the contents of an Address register, a Status register, the Temporary register or a Word Count register to the CPU. The outputs are disabled and the inputs are read during an I/O Write cycle when the CPU is programming the 8237A control registers. During DMA cycles the most significant 8 bits of the address are output onto the data bus to be strobed into an external latch by ADSTB. In mem-

Symbol	Type	Name and Function
		ory-to-memory operations, data from the memory comes into the 8237A on the data bus during the read-from-memory transfer. In the write-to-memory transfer, the data bus outputs place the data into the new memory location.
IOR	I/O	<b>I/O Read:</b> I/O Read is a bidirectional active low three-state line. In the Idle cycle, it is an input control signal used by the CPU to read the control registers. In the Active cycle, it is an output control signal used by the 8237A to access data from a peripheral during a DMA Write transfer.
IOW	I/O	<b>I/O Write:</b> I/O Write is a bidirectional active low three-state line. In the Idle cycle, it is an input control signal used by the CPU to load information into the 8237A. In the Active cycle, it is an output control signal used by the 8237A to load data to the peripheral during a DMA Read transfer.
EOP	I/O	<b>End of Process:</b> End of Process is an active low bidirectional signal. Information concerning the completion of DMA services is available at the bidirectional EOP pin. The 8237A allows an external signal to terminate an active DMA service. This is accomplished by pulling the EOP input low with an external EOP signal. The 8237A also generates a pulse when the terminal count (TC) for any channel is reached. This generates an EOP signal which is output through the EOP Line. The reception of EOP, either internal or external, will cause the 8237A to terminate the service, reset the request, and, if Autoinitialize is enabled, to write the base registers to the current registers of that channel. The mask bit and TC bit in the status word will be set for the currently active channel by EOP unless the channel is programmed for Autoinitialize. In that case, the mask bit remains unchanged. During memory-to-memory transfers, EOP will be output when the TC for channel 1 occurs. EOP should be tied high with a pull-up resistor if it is not used to prevent erroneous end of process inputs.
A0-A3	I/O	<b>Address:</b> The four least significant address lines are bidirectional three-state signals. In the Idle cycle they are inputs and are used by the CPU to address the register to be loaded or read. In the Active cycle they are outputs and provide the lower 4 bits of the output address.

Table 1. Pin Description (Continued)

Symbol	Type	Name and Function
A4-A7	O	<b>Address:</b> The four most significant address lines are three-state outputs and provide 4 bits of address. These lines are enabled only during the DMA service.
HRQ	O	<b>Hold Request:</b> This is the Hold Request to the CPU and is used to request control of the system bus. If the corresponding mask bit is clear, the presence of any valid DREQ causes 8237A to issue the HRQ.
DACK0-DACK3	O	<b>DMA Acknowledge:</b> DMA Acknowledge is used to notify the individual peripherals when one has been granted a DMA cycle. The sense of these lines is programmable. Reset initializes them to active low.

Symbol	Type	Name and Function
AEN	O	<b>Address Enable:</b> Address Enable enables the 8-bit latch containing the upper 8 address bits onto the system address bus. AEN can also be used to disable other system bus drivers during DMA transfers. AEN is active HIGH.
ADSTB	O	<b>Address Strobe:</b> The active high, Address Strobe is used to strobe the upper address byte into an external latch.
MEMR	O	<b>Memory Read:</b> The Memory Read signal is an active low three-state output used to access data from the selected memory location during a DMA Read or a memory-to-memory transfer.
MEMW	O	<b>Memory Write:</b> The Memory Write is an active low three-state output used to write data to the selected memory location during a DMA Write or a memory-to-memory transfer.

**FUNCTIONAL DESCRIPTION**

The 8237A block diagram includes the major logic blocks and all of the internal registers. The data inter-connection paths are also shown. Not shown are the various control signals between the blocks. The 8237A contains 344 bits of internal memory in the form of registers. Figure 3 lists these registers by name and shows the size of each. A detailed description of the registers and their functions can be found under Register Description.

Name	Size	Number
Base Address Registers	16 bits	4
Base Word Count Registers	16 bits	4
Current Address Registers	16 bits	4
Current Word Count Registers	16 bits	4
Temporary Address Register	16 bits	1
Temporary Word Count Register	16 bits	1
Status Register	8 bits	1
Command Register	8 bits	1
Temporary Register	8 bits	1
Mode Registers	6 bits	4
Mask Register	4 bits	1
Request Register	4 bits	1

Figure 3. 8237A Internal Registers

The 8237A contains three basic blocks of control logic. The Timing Control block generates internal timing and external control signals for the 8237A. The Program Command Control block decodes the various commands given to the 8237A by the microprocessor prior to servicing a DMA Request. It also decodes the Mode Control word used to select the type of DMA during the servicing. The Priority Encoder block resolves priority contention between DMA channels requesting service simultaneously.

The Timing Control block derives internal timing from the clock input. In 8237A systems this input will usually

be the  $\phi 2$  TTL clock from an 8224 or CLK from an 8085AH or 8284A. For 8085AH-2 systems above 3.9 MHz, the 8085 CLK(OUT) does not satisfy 8237A-5 clock LOW and HIGH time requirements. In this case, an external clock should be used to drive the 8237A-5.

**DMA Operation**

The 8237A is designed to operate in two major cycles. These are called Idle and Active cycles. Each device cycle is made up of a number of states. The 8237A can assume seven separate states, each composed of one full clock period. State 1 (S1) is the inactive state. It is entered when the 8237A has no valid DMA requests pending. While in S1, the DMA controller is inactive but may be in the Program Condition, being programmed by the processor. State S0 (S0) is the first state of a DMA service. The 8237A has requested a hold but the processor has not yet returned an acknowledge. The 8237A may still be programmed until it receives HLDA from the CPU. An acknowledge from the CPU will signal that DMA transfers may begin. S1, S2, S3 and S4 are the working states of the DMA service. If more time is needed to complete a transfer than is available with normal timing, wait states (SW) can be inserted between S2 or S3 and S4 by the use of the Ready line on the 8237A. Note that the data is transferred directly from the I/O device to memory (or vice versa) with  $\overline{IOR}$  and MEMW (or MEMR and  $\overline{IOW}$ ) being active at the same time. The data is not read into or driven out of the 8237A in I/O-to-memory or memory-to-I/O DMA transfers.

Memory-to-memory transfers require a read-from and a write-to-memory to complete each transfer. The states, which resemble the normal working states, use two digit numbers for identification. Eight states are required for a single transfer. The first four states (S11, S12, S13, S14) are used for the read-from-memory half



### 8237A/8237A-4/8237A-5

and the last four states (S21, S22, S23, S24) for the write-to-memory half of the transfer.

#### IDLE CYCLE

When no channel is requesting service, the 8237A will enter the Idle cycle and perform "SI" states. In this cycle the 8237A will sample the DREQ lines every clock cycle to determine if any channel is requesting a DMA service. The device will also sample CS, looking for an attempt by the microprocessor to write or read the internal registers of the 8237A. When CS is low and HLDA is low, the 8237A enters the Program Condition. The CPU can now establish, change or inspect the internal definition of the part by reading from or writing to the internal registers. Address lines A0-A3 are inputs to the device and select which registers will be read or written. The IOR and IOW lines are used to select and time reads or writes. Due to the number and size of the internal registers, an internal flip-flop is used to generate an additional bit of address. This bit is used to determine the upper or lower byte of the 16-bit Address and Word Count registers. The flip-flop is reset by Master Clear or Reset. A separate software command can also reset this flip-flop.

Special software commands can be executed by the 8237A in the Program Condition. These commands are decoded as sets of addresses with the CS and IOW. The commands do not make use of the data bus. Instructions include Clear First/Last Flip-Flop and Master Clear.

#### ACTIVE CYCLE

When the 8237A is in the Idle cycle and a non-masked channel requests a DMA service, the device will output an HRQ to the microprocessor and enter the Active cycle. It is in this cycle that the DMA service will take place, in one of four modes:

**Single Transfer Mode** — In Single Transfer mode the device is programmed to make one transfer only. The word count will be decremented and the address decremented or incremented following each transfer. When the word count "rolls over" from zero to FFFFH, a Terminal Count (TC) will cause an Autoinitialize if the channel has been programmed to do so.

DREQ must be held active until DACK becomes active in order to be recognized. If DREQ is held active throughout the single transfer, HRQ will go inactive and release the bus to the system. It will again go active and, upon receipt of a new HLDA, another single transfer will be performed. In 8080A, 8085AH, 8088, or 8086 system this will ensure one full machine cycle execution between DMA transfers. Details of timing between the 8237A and other bus control protocols will depend upon the characteristics of the microprocessor involved.

**Block Transfer Mode** — In Block Transfer mode the device is activated by DREQ to continue making transfers during the service until a TC, caused by word count going to FFFFH, or an external End of Process (EOP) is encountered. DREQ need only be held active until DACK

becomes active. Again, an Autoinitialization will occur at the end of the service if the channel has been programmed for it.

**Demand Transfer Mode** — In Demand Transfer mode the device is programmed to continue making transfers until a TC or external EOP is encountered or until DREQ goes inactive. Thus transfers may continue until the I/O device has exhausted its data capacity. After the I/O device has had a chance to catch up, the DMA service is re-established by means of a DREQ. During the time between services when the microprocessor is allowed to operate, the intermediate values of address and word count are stored in the 8237A Current Address and Current Word Count registers. Only an EOP can cause an Autoinitialize at the end of the service. EOP is generated either by TC or by an external signal.

**Cascade Mode**— This mode is used to cascade more than one 8237A together for simple system expansion. The HRQ and HLDA signals from the additional 8237A are connected to the DREQ and DACK signals of a channel of the initial 8237A. This allows the DMA requests of the additional device to propagate through the priority network circuitry of the preceding device. The priority chain is preserved and the new device must wait for its turn to acknowledge requests. Since the cascade channel of the initial 8237A is used only for prioritizing the additional device, it does not output any address or control signals of its own. These could conflict with the outputs of the active channel in the added device. The 8237A will respond to DREQ and DACK but all other outputs except HRQ will be disabled. The ready input is ignored.

Figure 4 shows two additional devices cascaded into an initial device using two of the previous channels. This forms a two level DMA system. More 8237As could be added at the second level by using the remaining channels of the first level. Additional devices can also be added by cascading into the channels of the second level devices, forming a third level.

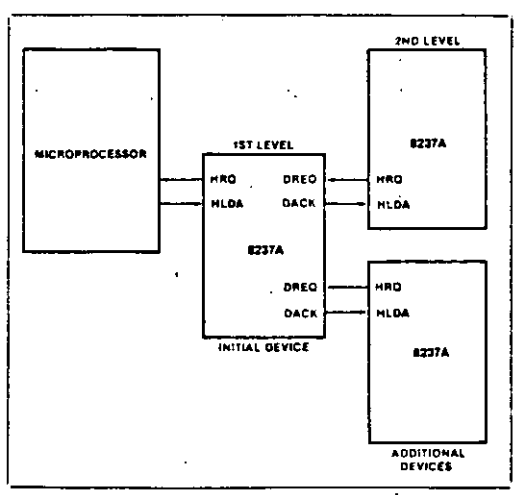

Figure 4. Cascaded 8237As



## 8237A/8237A-4/8237A-5

## TRANSFER TYPES

Each of the three active transfer modes can perform three different types of transfers. These are Read, Write and Verify. Write transfers move data from and I/O device to the memory by activating  $\overline{\text{MEMW}}$  and  $\overline{\text{IOR}}$ . Read transfers move data from memory to an I/O device by activating  $\overline{\text{MEMR}}$  and  $\overline{\text{IOW}}$ . Verify transfers are pseudo transfers. The 8237A operates as in Read or Write transfers generating addresses, and responding to EOP, etc. However, the memory and I/O control lines all remain inactive. The ready input is ignored in verify mode.

**Memory-to-Memory**—To perform block moves of data from one memory address space to another with a minimum of program effort and time, the 8237A includes a memory-to-memory transfer feature. Programming a bit in the Command register selects channels 0 to 1 to operate as memory-to-memory transfer channels. The transfer is initiated by setting the software DREQ for channel 0. The 8237A requests a DMA service in the normal manner. After HLDA is true, the device, using four state transfers in Block Transfer mode, reads data from the memory. The channel 0 Current Address register is the source for the address used and is decremented or incremented in the normal manner. The data byte read from the memory is stored in the 8237A internal Temporary register. Channel 1 then performs a four-state transfer of the data from the Temporary register to memory using the address in its Current Address register and incrementing or decrementing it in the normal manner. The channel 1 current Word Count is decremented. When the word count of channel 1 goes to FFFFH, a TC is generated causing an EOP output terminating the service.

Channel 0 may be programmed to retain the same address for all transfers. This allows a single word to be written to a block of memory.

The 8237A will respond to external  $\overline{\text{EOP}}$  signals during memory-to-memory transfers. Data comparators in block search schemes may use this input to terminate the service when a match is found. The timing of memory-to-memory transfers is found in Figure 12. Memory-to-memory operations can be detected as an active AEN with no DACK outputs.

**Autoinitialize**—By programming a bit in the Mode register, a channel may be set up as an Autoinitialize channel. During Autoinitialize initialization, the original values of the Current Address and Current Word Count registers are automatically restored from the Base Address and Base Word count registers of that channel following EOP. The base registers are loaded simultaneously with the current registers by the microprocessor and remain unchanged throughout the DMA service. The mask bit is not altered when the channel is in Autoinitialize. Following Autoinitialize the channel is ready to perform another DMA service, without CPU intervention, as soon as a valid DREQ is detected. In order to Autoinitialize both channels in a memory-to-memory transfer, both word counts should be programmed identically. If interrupted externally, EOP pulses should be applied in both bus cycles.

**Priority**—The 8237A has two types of priority encoding available as software selectable options. The first is Fixed Priority

which fixes the channels in priority order based upon the descending value of their number. The channel with the lowest priority is 3 followed by 2, 1 and the highest priority channel, 0. After the recognition of any one channel for service, the other channels are prevented from interfering with that service until it is completed.

The second scheme is Rotating Priority. The last channel to get service becomes the lowest priority channel with the others rotating accordingly.

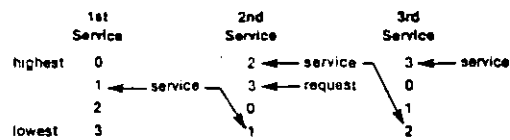

With Rotating Priority in a single chip DMA system, any device requesting service is guaranteed to be recognized after no more than three higher priority services have occurred. This prevents any one channel from monopolizing the system.

**Compressed Timing**—In order to achieve even greater throughput where system characteristics permit, the 8237A can compress the transfer time to two clock cycles. From Figure 11 it can be seen that state S3 is used to extend the access time of the read pulse. By removing state S3, the read pulse width is made equal to the write pulse width and a transfer consists only of state S2 to change the address and state S4 to perform the read/write. S1 states will still occur when A8-A15 need updating (see Address Generation). Timing for compressed transfers is found in Figure 14.

**Address Generation**—In order to reduce pin count, the 8237A multiplexes the eight higher order address bits on the data lines. State S1 is used to output the higher order address bits to an external latch from which they may be placed on the address bus. The falling edge of Address Strobe (ADSTB) is used to load these bits from the data lines to the latch. Address Enable (AEN) is used to enable the bits onto the address bus through a three-state enable. The lower order address bits are output by the 8237A directly. Lines A0-A7 should be connected to the address bus. Figure 11 shows the time relationships between CLK, AEN, ADSTB, DB0-DB7 and A0-A7.

During Block and Demand Transfer mode services, which include multiple transfers, the addresses generated will be sequential. For many transfers the data held in the external address latch will remain the same. This data need only change when a carry or borrow from A7 to A8 takes place in the normal sequence of addresses. To save time and speed transfers, the 8237A executes S1 states only when updating of A8-A15 in the latch is necessary. This means for long services, S1 states and Address Strobes may occur only once every 256 transfers, a savings of 255 clock cycles for each 256 transfers.



REGISTER DESCRIPTION

**Current Address Register** — Each channel has a 16-bit Current Address register. This register holds the value of the address used during DMA transfers. The address is automatically incremented or decremented after each transfer and the intermediate values of the address are stored in the Current Address register during the transfer. This register is written or read by the microprocessor in successive 8-bit bytes. It may also be reinitialized by an Autoinitialize back to its original value. Autoinitialize takes place only after an EOP.

**Current Word Register** — Each channel has a 16-bit Current Word Count register. This register determines the number of transfers to be performed. The actual number of transfers will be one more than the number programmed in the Current Word Count register (i.e., programming a count of 100 will result in 101 transfers). The word count is decremented after each transfer. The intermediate value of the word count is stored in the register during the transfer. When the value in the register goes from zero to FFFFH, a TC will be generated. This register is loaded or read in successive 8-bit bytes by the microprocessor in the Program Condition. Following the end of a DMA service it may also be reinitialized by an Autoinitialization back to its original value. Autoinitialize can occur only when an EOP occurs. If it is not Autoinitialized, this register will have a count of FFFFH after TC.

**Base Address and Base Word Count Registers** — Each channel has a pair of Base Address and Base Word Count registers. These 16-bit registers store the original value of their associated current registers. During Autoinitialize these values are used to restore the current registers to their original values. The base registers are written simultaneously with their corresponding current register in 8-bit bytes in the Program Condition by the microprocessor. These registers cannot be read by the microprocessor.

**Command Register** — This 8-bit register controls the operation of the 8237A. It is programmed by the microprocessor in the Program Condition and is cleared by Reset or a Master Clear instruction. The following table lists the function of the command bits. See Figure 6 for address coding.

**Mode Register** — Each channel has a 6-bit Mode register associated with it. When the register is being written to by the microprocessor in the Program Condition, bits 0 and 1 determine which channel Mode register is to be written.

**Request Register** — The 8237A can respond to requests for DMA service which are initiated by software as well as by a DREQ. Each channel has a request bit associated with it in the 4-bit Request register. These are non-maskable and subject to prioritization by the Priority Encoder network. Each register bit is set or reset separately under software control or is cleared upon generation of a TC or external EOP. The entire register is cleared by a Reset. To set or reset a bit, the software loads the proper form of the data word. See Figure 5 for register address coding. In order to make a software request, the channel must be in Block Mode.

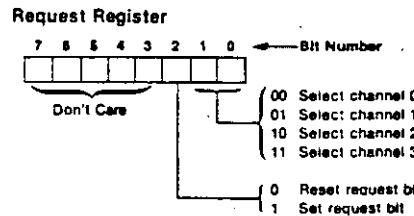
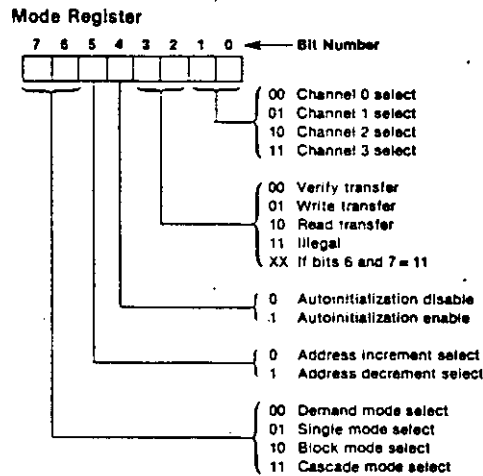
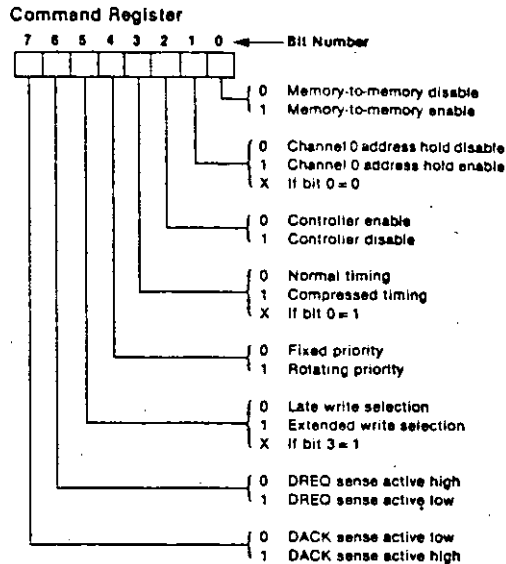



**Mask Register** — Each channel has associated with it a mask bit which can be set to disable the incoming DREQ. Each mask bit is set when its associated channel produces an  $\overline{EOP}$  if the channel is not programmed for Autoinitialize. Each bit of the 4-bit Mask register may also be set or cleared separately under software control. The entire register is also set by a Reset. This disables all DMA requests until a clear Mask register instruction allows them to occur. The instruction to separately set or clear the mask bits is similar in form to that used with the Request register. See Figure 5 for instruction addressing.

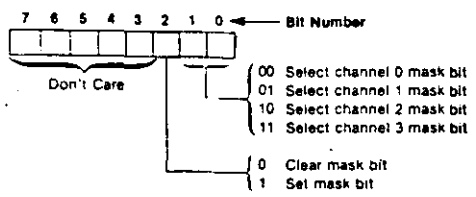

All four bits of the Mask register may also be written with a single command.

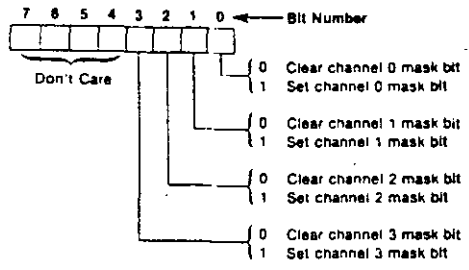

Register	Operation	Signals						
		CS	IOR	IOW	A3	A2	A1	A0
Command	Write	0	1	0	1	0	0	0
Mode	Write	0	1	0	1	0	1	1
Request	Write	0	1	0	1	0	0	1
Mask	Set/Reset	0	1	0	1	0	1	0
Mask	Write	0	1	0	1	1	1	1
Temporary	Read	0	0	1	1	1	0	1
Status	Read	0	0	1	1	0	0	0

Figure 5. Definition of Register Codes

**Status Register** — The Status register is available to be read out of the 8237A by the microprocessor. It contains information about the status of the devices at this point. This information includes which channels have reached a terminal count and which channels have pending DMA requests. Bits 0-3 are set every time a TC is reached by that channel or an external  $\overline{EOP}$  is applied. These bits are cleared upon Reset and on each Status Read. Bits 4-7 are set whenever their corresponding channel is requesting service.

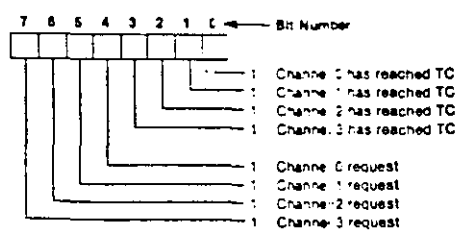

**Temporary Register** — The Temporary register is used to hold data during memory-to-memory transfers. Following the completion of the transfers, the last word moved can be read by the microprocessor in the Program Condition. The Temporary register always contains the last byte transferred in the previous memory-to-memory operation, unless cleared by a Reset.

**Software Commands**—These are additional special software commands which can be executed in the Program Condition. They do not depend on any specific bit pattern on the data bus. The three software commands are:

**Clear First/Last Flip-Flop:** This command is executed prior to writing or reading new address or word count information to the 8237A. This initializes the flip-flop to a known state so that subsequent accesses to register contents by the microprocessor will address upper and lower bytes in the correct sequence.

**Master Clear:** This software instruction has the same effect as the hardware Reset. The Command, Status, Request, Temporary, and Internal First/Last Flip-Flop registers are cleared and the Mask register is set. The 8237A will enter the Idle cycle.

**Clear Mask Register:** This command clears the mask bits of all four channels, enabling them to accept DMA requests.

Figure 6 lists the address codes for the software commands:

Signals							Operation
A3	A2	A1	A0	IOR	IOW		
1	0	0	0	0	1	0	Read Status Register
1	0	0	0	1	0	0	Write Command Register
1	0	0	1	0	1	0	Illegal
1	0	0	1	1	0	0	Write Request Register
1	0	1	0	0	1	0	Illegal
1	0	1	0	1	0	0	Write Single Mask Register Bit
1	0	1	1	0	1	0	Illegal
1	0	1	1	1	0	0	Write Mode Register
1	1	0	0	0	0	1	Illegal
1	1	0	0	1	0	0	Clear Byte Pointer Flip-Flop
1	1	0	1	0	1	0	Read Temporary Register
1	1	0	1	1	0	0	Master Clear
1	1	1	0	0	1	0	Illegal
1	1	1	0	1	0	0	Clear Mask Register
1	1	1	1	0	1	0	Illegal
1	1	1	1	1	1	0	Write All Mask Register Bits

Figure 6. Software Command Codes

Channel	Register	Operation	Signals						Internal Flip-Flop	Data Bus DB0-DB7	
			CS	I/O	IOW	A3	A2	A1			A0
0	Base and Current Address	Write	0	1	0	0	0	0	0	0	A0-A7
			0	1	0	0	0	0	0	1	A8-A15
	Current Address	Read	0	0	1	0	0	0	0	0	A0-A7
			0	0	1	0	0	0	0	1	A8-A15
Base and Current Word Count	Write	0	1	0	0	0	0	1	0	W0-W7	
		0	1	0	0	0	0	1	1	W8-W15	
Current Word Count	Read	0	0	1	0	0	0	1	0	W0-W7	
		0	0	1	0	0	0	1	1	W8-W15	
1	Base and Current Address	Write	0	1	0	0	0	1	0	0	A0-A7
			0	1	0	0	0	1	0	1	A8-A15
	Current Address	Read	0	0	1	0	0	1	0	0	A0-A7
			0	0	1	0	0	1	0	1	A8-A15
Base and Current Word Count	Write	0	1	0	0	0	1	1	0	W0-W7	
		0	1	0	0	0	1	1	1	W8-W15	
Current Word Count	Read	0	0	1	0	0	1	1	0	W0-W7	
		0	0	1	0	0	1	1	1	W8-W15	
2	Base and Current Address	Write	0	1	0	0	1	0	0	0	A0-A7
			0	1	0	0	1	0	0	1	A8-A15
	Current Address	Read	0	0	1	0	1	0	0	0	A0-A7
			0	0	1	0	1	0	0	1	A8-A15
Base and Current Word Count	Write	0	1	0	0	1	0	1	0	W0-W7	
		0	1	0	0	1	0	1	1	W8-W15	
Current Word Count	Read	0	0	1	0	1	0	1	0	W0-W7	
		0	0	1	0	1	0	1	1	W8-W15	
3	Base and Current Address	Write	0	1	0	0	1	1	0	0	A0-A7
			0	1	0	0	1	1	0	1	A8-A15
	Current Address	Read	0	0	1	0	1	1	0	0	A0-A7
			0	0	1	0	1	1	0	1	A8-A15
Base and Current Word Count	Write	0	1	0	0	1	1	1	0	W0-W7	
		0	1	0	0	1	1	1	1	W8-W15	
Current Word Count	Read	0	0	1	0	1	1	1	0	W0-W7	
		0	0	1	0	1	1	1	1	W8-W15	

Figure 7. Word Count and Address Register Command Codes

**PROGRAMMING**

The 8237A will accept programming from the host processor any time that HLDA is inactive; this is true even if HRQ is active. The responsibility of the host is to assure that programming and HLDA are mutually exclusive. Note that a problem can occur if a DMA request occurs, on an unmasked channel while the 8237A is being programmed. For instance, the CPU may be starting to reprogram the two byte Address register of channel 1 when channel 1 receives a DMA request. If the 8237A is enabled (bit 2 in the command register is 0) and channel 1 is unmasked, a DMA service will occur after only one byte of the Address register has been reprogrammed. This can be avoided by disabling the controller (setting bit 2 in the command register) or masking the channel before programming any other registers. Once the programming is complete, the controller can be enabled/unmasked.

After power-up it is suggested that all internal locations, especially the Mode registers, be loaded with some valid value. This should be done even if some channels are unused.



### 8237A/8237A-4/8237A-5

#### APPLICATION INFORMATION

Figure 8 shows a convenient method for configuring a DMA system with the 8237A controller and an 8080A/8085AH microprocessor system. The multimode DMA controller issues a HRQ to the processor whenever there is at least one valid DMA request from a peripheral device. When the processor replies with a HLDA signal, the 8237A takes control of the address bus, the data bus and the control bus. The address for the first transfer

operation comes out in two bytes — the least significant 8 bits on the eight address outputs and the most significant 8 bits on the data bus. The contents of the data bus are then latched into the 8282 8-bit latch to complete the full 16 bits of the address bus. The 8282 is a high speed, 8-bit, three-state latch in a 20-pin package. After the initial transfer takes place, the latch is updated only after a carry or borrow is generated in the least significant address byte. Four DMA channels are provided when one 8237A is used.

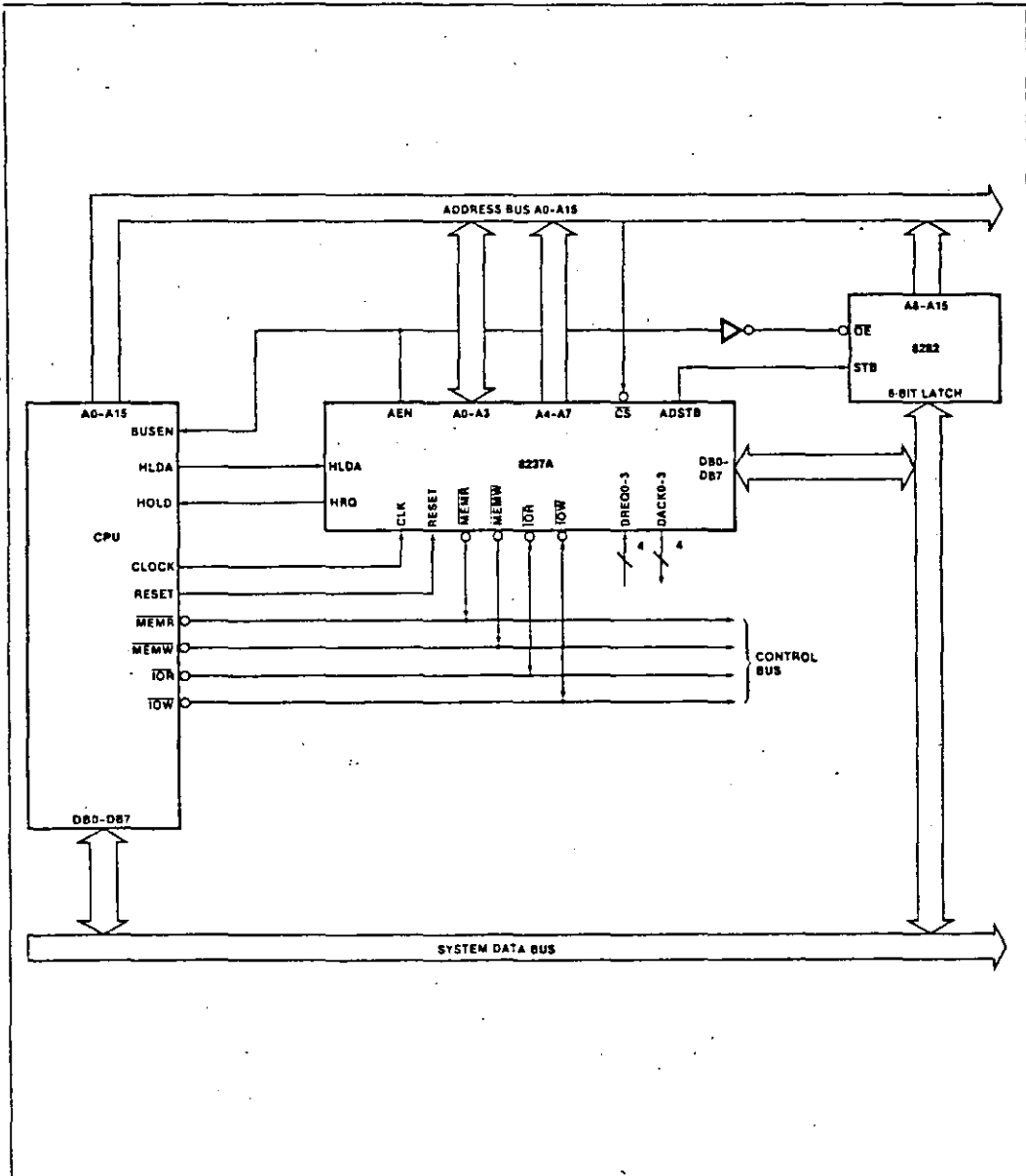

Figure 8. 8237A System Interface



8237A/8237A-4/8237A-5

**ABSOLUTE MAXIMUM RATINGS\***

Ambient Temperature under Bias ..... 0°C to 70°C  
 Storage Temperature ..... - 65°C to + 150°C  
 Voltage on any Pin with  
   Respect to Ground ..... - 0.5 to 7V  
 Power Dissipation ..... 1.5 Watt

*\*NOTICE: Stresses above those listed under "Absolute Maximum Ratings" may cause permanent damage to the device. This is a stress rating only and functional operation of the device at these or any other conditions above those indicated in the operational sections of this specification is not implied. Exposure to absolute maximum rating conditions for extended periods may affect device reliability.*

**D.C. CHARACTERISTICS** ( $T_A = 0^\circ\text{C}$  to  $70^\circ\text{C}$ ,  $V_{CC} = 5.0\text{V} \pm 5\%$ ,  $\text{GND} = 0\text{V}$ )

Symbol	Parameter	Min.	Typ.(1)	Max.	Unit	Test Conditions
$V_{OH}$	Output High Voltage	2.4			V	$I_{OH} = -200 \mu\text{A}$
		3.3			V	$I_{OH} = -100 \mu\text{A}$ (HRQ Only)
$V_{OL}$	Output LOW Voltage			.40	V	$I_{OL} = 2.0\text{mA}$ (data Bus, $\overline{\text{EOP}}$ ) $I_{OL} = 3.2\text{mA}$ (other outputs) $I_{OL} = 2.5\text{mA}$ (ADSTB) (Note 8)
$V_{IH}$	Input HIGH Voltage	2.0		$V_{CC} + 0.5$	V	(Note 8)
$V_{IL}$	Input LOW Voltage	-0.5		0.8	V	
$I_{I1}$	Input Load Current			$\pm 10$	$\mu\text{A}$	$0\text{V} \leq V_{IN} \leq V_{CC}$
$I_{LO}$	Output Leakage Current			$\pm 10$	$\mu\text{A}$	$0.45\text{V} \leq V_{OUT} \leq V_{CC}$
$I_{CC}$	$V_{CC}$ Supply Current		110	130	mA	$T_A = +25^\circ\text{C}$
			130	150	mA	$T_A = 0^\circ\text{C}$
$C_O$	Output Capacitance		4	8	pF	$t_c = 1.0 \text{ MHz}$ , Inputs = 0V
$C_I$	Input Capacitance		8	15	pF	
$C_{I/O}$	I/O Capacitance		10	18	pF	

- NOTES:**
- Typical values are for  $T_A = 25^\circ\text{C}$ , nominal supply voltage and nominal processing parameters.
  - Input timing parameters assume transition times to 20 ns or less. Waveform measurement points for both input and output signals are 2.0V for HIGH and 0.8V for LOW, unless otherwise noted.
  - Output loading is 1 TTL gate plus 150pF capacitance, unless otherwise noted.
  - The net  $\overline{\text{IOW}}$  or  $\overline{\text{MEMW}}$  Pulse width for normal write will be  $\text{TCY}-100 \text{ ns}$  and for extended write will be  $2\text{TCY}-100 \text{ ns}$ . The net  $\overline{\text{IOR}}$  or  $\overline{\text{MEMR}}$  pulse width for normal read will be  $2\text{TCY}-50 \text{ ns}$  and for compressed read will be  $\text{TCY}-50 \text{ ns}$ .
  - $\text{TDO}$  is specified for two different output HIGH levels.  $\text{TDO1}$  is measured at 2.0V.  $\text{TDO2}$  is measured at 3.3V. The value for  $\text{TDO2}$  assumes an external 3.3K $\Omega$  pull-up resistor connected from HRQ to  $V_{CC}$ .
  - DREQ should be held active until DACK is returned.
  - DREQ and DACK signals may be active high or active low. Timing diagrams assume the active high mode.
  - The values of  $V_{OL}$  and  $V_{IH}$  have been changed from the 1985 specification to allow more design margin.
  - Successive read and/or write operations by the external processor to program or examine the controller must be timed to allow at least 600 ns for the 8237A, at least 500 ns for the 8237A-4 and at least 400 ns for the 8237A-5, as recovery time between active read or write pulses. The same recovery time is needed between an active read or write pulse followed by a DMA transfer.
  - $\overline{\text{EOP}}$  is an open collector output. This parameter assumes the presence of a 2.2K pullup to  $V_{CC}$ .
  - Pin 5 is an input that should always be at a logic high level. An internal pull-up resistor will establish a logic high when the pin is left floating. It is recommended however, that pin 5 be tied to  $V_{CC}$ .
  - Output Loading on the Data Bus is 1  $\tau_L$  Gate plus 100pF capacitance.

**A.C. TESTING INPUT, OUTPUT WAVEFORM**

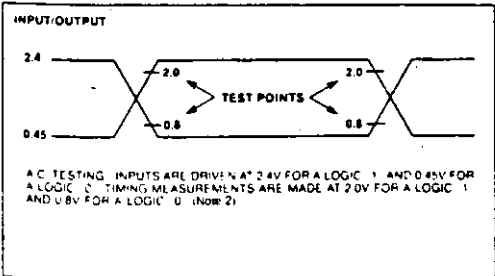



8237A/8237A-4/8237A-5

A.C. CHARACTERISTICS—DMA (MASTER) MODE (T<sub>A</sub> = 0°C to 70°C, V<sub>CC</sub> = +5V ± 5%, GND = 0V)

Symbol	Parameter	8237A		8237A-4		8237A-5		Unit
		Min.	Max.	Min.	Max.	Min.	Max.	
TAEL	MEMR HIGH from CLK LOW (SI) Delay Time		300		225		200	ns
TAET	MEMR LOW from CLK HIGH (SI) Delay Time		200		150		130	ns
TAFAB	MEMR Active to Float Delay from CLK HIGH		150		120		90	ns
TAFAC	MEMR Active to Float Delay from CLK HIGH		150		120		120	ns
TAFDB	MEMR Active to Float Delay from CLK HIGH		250		190		170	ns
TAHR	MEMR from READ HIGH Hold Time	TCY-100		TCY-100		TCY-100		ns
TAHS	MEMR from ADSTB LOW Hold Time	40		40		30		ns
TAHW	MEMR from WRITE HIGH Hold Time	TCY-50		TCY-50		TCY-50		ns
TAK	MEMR Valid from CLK LOW Delay Time (Note 7)		250		220		170	ns
	MEMR HIGH from CLK HIGH Delay Time (Note 10)		250		190		170	ns
	MEMR LOW from CLK HIGH Delay Time		250		190		170	ns
TASM	MEMR Stable from CLK HIGH		250		190		170	ns
TASS	MEMR to ADSTB LOW Setup Time	100		100		100		ns
TCH	MEMR Clock High Time (Transitions < 10 ns)	120		100		80		ns
TCL	MEMR Clock Low Time (Transitions < 10 ns)	150		110		88		ns
TCY	MEMR Clock Cycle Time	320		250		200		ns
TDCL	MEMR CLK HIGH to READ or WRITE LOW Delay (Note 4)		270		200		190	ns
TDCTR	MEMR READ HIGH from CLK HIGH (S4) Delay Time (Note 4)		270		210		190	ns
TDCTW	MEMR WRITE HIGH from CLK HIGH (S4) Delay Time (Note 4)		200		150		130	ns
TDQ1	MEMRQ Valid from CLK HIGH Delay Time (Note 5)		160		120		120	ns
TDQ2			250		190		120	ns
TEPS	MEMRQ LOW from CLK LOW Setup Time	60		45		40		ns
TEPW	MEMRQ Pulse Width	300		225		220		ns
TFAAB	MEMR Float to Active Delay from CLK HIGH		250		190		170	ns
TFAAC	MEMR Active from CLK HIGH		200		150		150	ns
TFADB	MEMR Float to Active Delay from CLK HIGH		300		225		200	ns
THS	MEMRDLDA Valid to CLK HIGH Setup Time	100		75		75		ns
TICH	MEMR Input Data from MEMR HIGH Hold Time	0		0		0		ns
TICS	MEMR Input Data to MEMR HIGH Setup Time	250		190		170		ns
TOCH	MEMR Output Data from MEMR HIGH Hold Time	20		20		10		ns
TOCV	MEMR Output Data Valid to MEMR HIGH	200		125		125		ns
TCS	MEMRQ to CLK LOW (SI, S4) Setup Time (Note 7)	0		0		0		ns
TRH	MEMRQ to READY LOW Hold Time	20		20		20		ns
TRS	MEMRQ to CLK LOW Setup Time	100		60		60		ns
TS <sup>HL</sup>	MEMR ADSTB HIGH from CLK HIGH Delay Time		200		150		130	ns
TS <sup>LL</sup>	MEMR ADSTB LOW from CLK HIGH Delay Time		140		110		90	ns



8237A/8237A-4/8237A-5

A.C. CHARACTERISTICS—PERIPHERAL (SLAVE) MODE (T<sub>A</sub> = 0°C to 70°C, V<sub>CC</sub> = 5.0V ±5%, GND = 0V)

Symbol	Parameter	8237A		8237A-4		8237A-5		Unit
		Min.	Max.	Min.	Max.	Min.	Max.	
TAR	ADR Valid or CS LOW to READ LOW	50		50		50		ns
TAW	ADR Valid to WRITE HIGH Setup Time	200		150		130		ns
TCW	CS LOW to WRITE HIGH Setup Time	200		150		130		ns
TDW	Data Valid to WRITE HIGH Setup Time	200		150		130		ns
TRA	ADR or CS Hold from READ HIGH	0		0		0		ns
TRDE	Data Access from READ LOW (Note 12)		200		200		140	ns
TRDF	DB Float Delay from READ HIGH	20	100	20	100	0	70	ns
TRSTD	Power Supply HIGH to RESET LOW Setup Time	500		500		500		ns
TRSTS	RESET to First IOWR	2TCY		2TCY		2TCY		ns
TRSTW	RESET Pulse Width	300		300		300		ns
TRW	READ Width	300		250		200		ns
TWA	ADR from WRITE HIGH Hold Time	20		20		20		ns
TWC	CS HIGH from WRITE HIGH Hold Time	20		20		20		ns
TWD	Data from WRITE HIGH Hold Time	30		30		30		ns
TWWS	Write Width	200		200		160		ns

WAVEFORMS

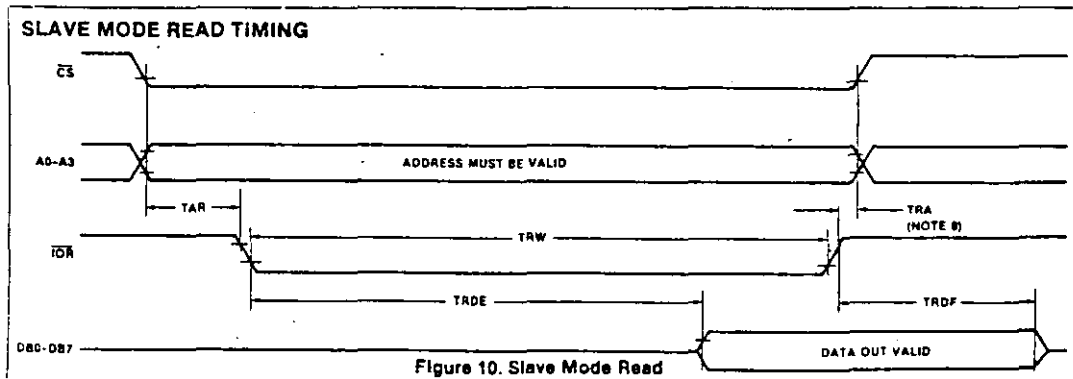
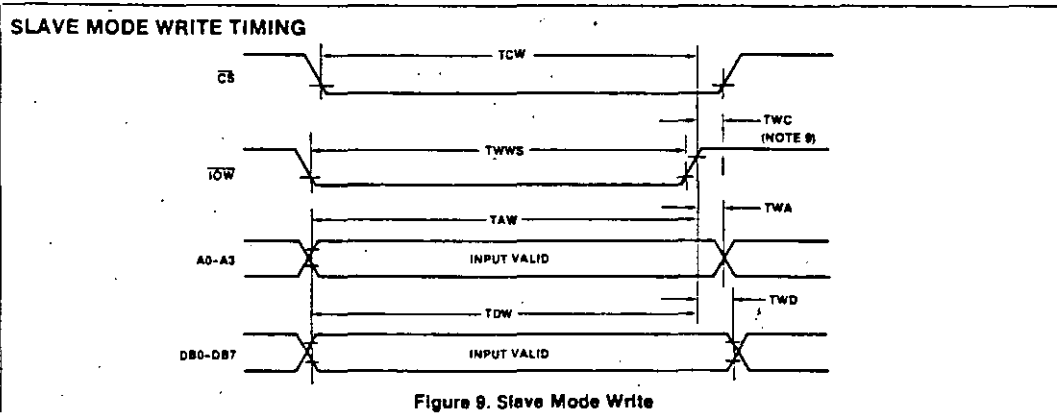



WAVEFORMS (Continued)

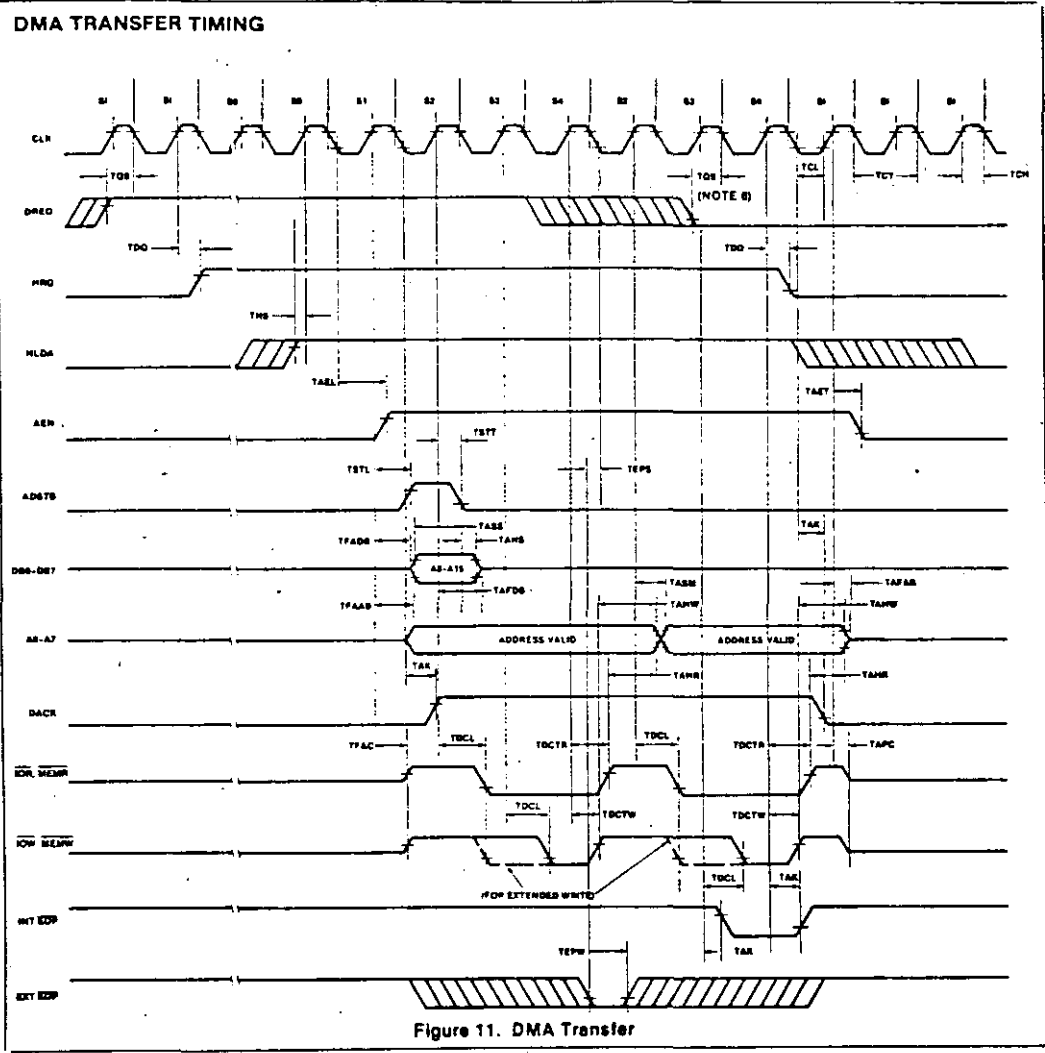



WAVEFORMS (Continued)

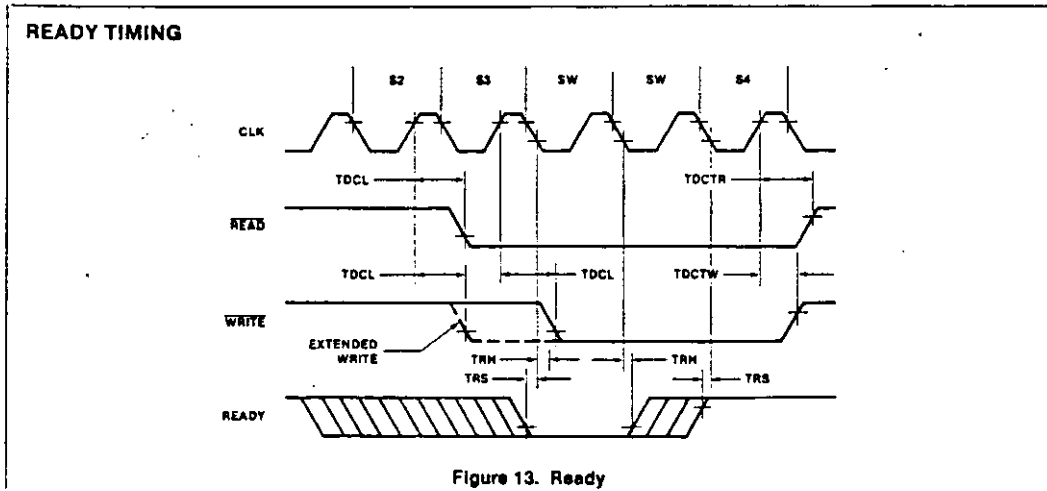
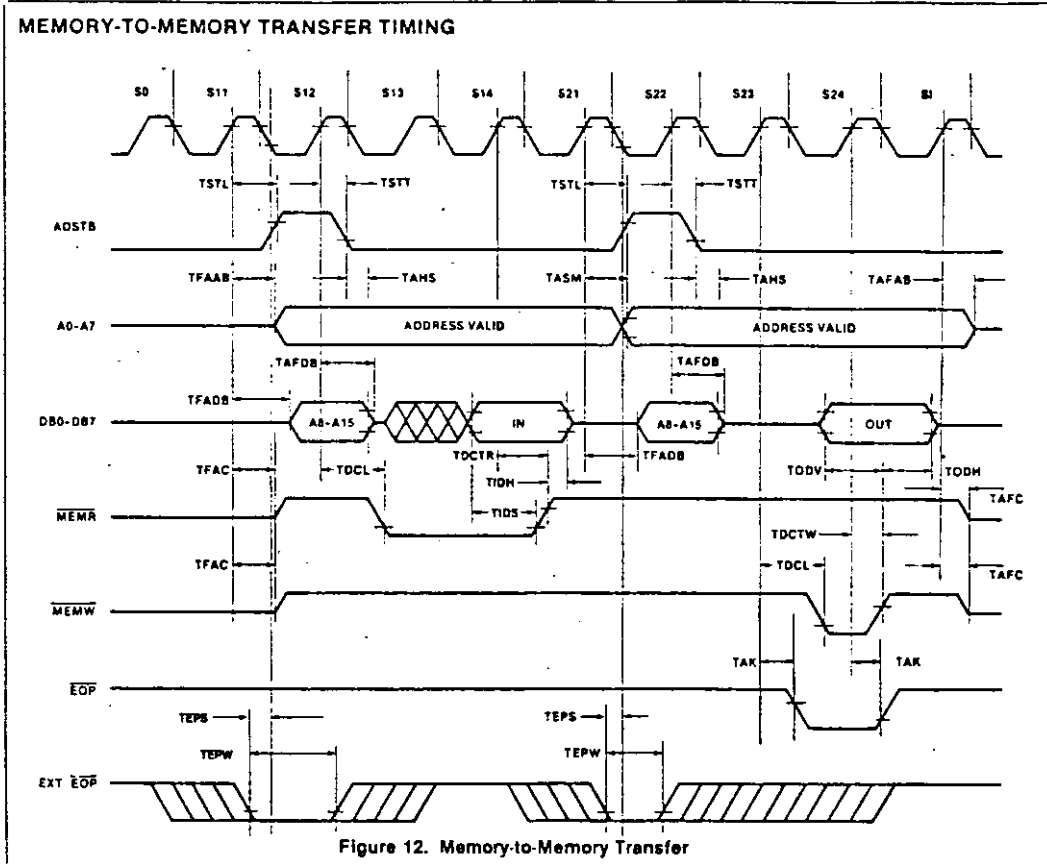

WAVEFORMS (Continued)

COMPRESSED TRANSFER TIMING

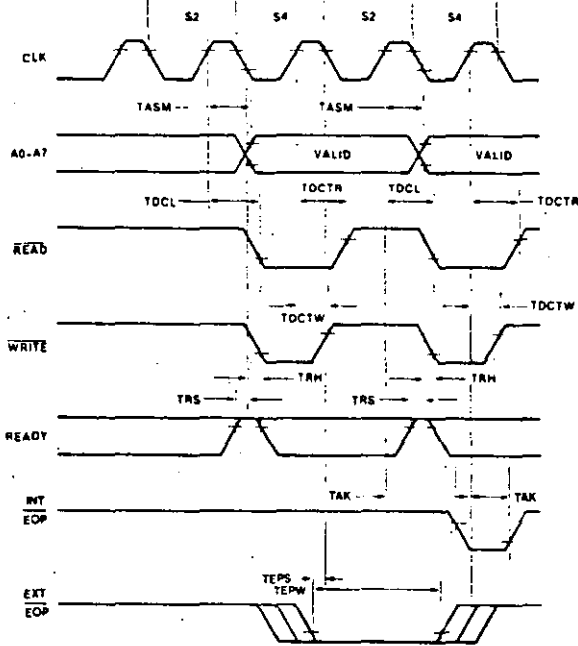

Figure 14. Compressed Transfer

RESET TIMING

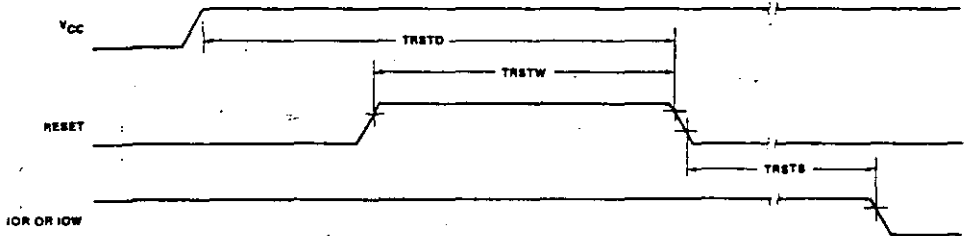

Figure 15. Reset



## 8257/8257-5 PROGRAMMABLE DMA CONTROLLER

- MCS-85<sup>®</sup> Compatible 8257-5
  - 4-Channel DMA Controller
  - Priority DMA Request Logic
  - Channel Inhibit Logic
  - Terminal Count and Modulo 128 Outputs
  - Single TTL Clock
  - Single +5V Supply
  - Auto Load Mode
  - Available in EXPRESS - Standard Temperature Range
  - Available in 40-Lead Cerdip and Plastic Package.
- (See Packaging Spec. Order #231369)

The Intel<sup>®</sup> 8257 is a 4-channel direct memory access (DMA) controller. It is specifically designed to simplify the transfer of data at high speeds for the Intel<sup>®</sup> microcomputer systems. Its primary function is to generate, upon a peripheral request, a sequential memory address which will allow the peripheral to read or write data directly to or from memory. Acquisition of the system bus is accomplished via the CPU's hold function. The 8257 has priority logic that resolves the peripherals requests and issues a composite hold request to the CPU. It maintains the DMA cycle count for each channel and outputs a control signal to notify the peripheral that the programmed number of DMA cycles is complete. Other output control signals simplify sectorized data transfers. The 8257 represents a significant savings in component count for DMA-based microcomputer systems and greatly simplifies the transfer of data at high speed between peripherals and memories.

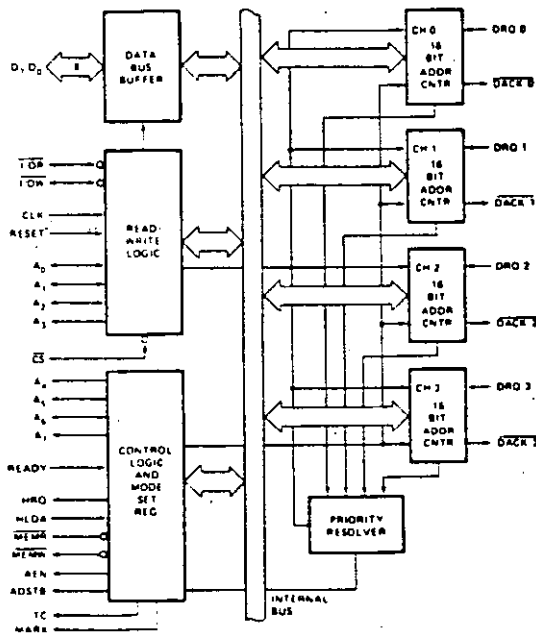

Figure 1. Block Diagram

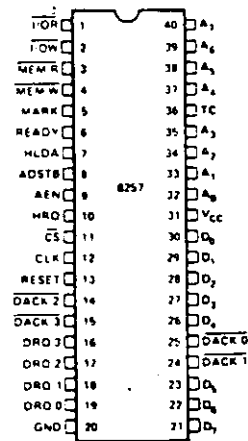

Figure 2. Pin Configuration

## FUNCTIONAL DESCRIPTION

### General

The 8257 is a programmable, Direct Memory Access (DMA) device which, when coupled with a single 8-bit latch provides a complete four-channel DMA controller for use in Intel microcomputer systems. After being initialized by software, the 8257 can transfer a block of data, containing up to 16,384 bytes, between memory and a peripheral device directly, without further intervention required of the CPU. Upon receiving a DMA transfer request from an enabled peripheral, the 8257:

1. Acquires control of the system bus.
2. Acknowledges that requesting peripheral which is connected to the highest priority channel.
3. Outputs the least significant eight bits of the memory address onto system address lines  $A_7-A_0$ , outputs the most significant eight bits of the memory address to the 6-bit latch via the data bus (the outputs of the latch should drive address lines  $A_{15}-A_8$ ), and
4. Generates the appropriate memory and I/O read/write control signals that cause the peripheral to receive or deposit a data byte directly from or to the addressed location in memory.

The 8257 will retain control of the system bus and repeat the transfer sequence, as long as a peripheral maintains its DMA request. Thus, the 8257 can transfer a block of data to/from a high speed peripheral (e.g., a sector of data on a floppy disk) in a single "burst". When the specified number of data bytes have been transferred, the 8257 activates its Terminal Count (TC) output, informing the CPU that the operation is complete.

The 8257 offers three different modes of operation: (1) DMA read, which causes data to be transferred from memory to a peripheral; (2) DMA write, which causes data to be transferred from a peripheral to memory; and (3) DMA verify, which does not actually involve the transfer of data. When an 8257 channel is in the DMA verify mode, it will respond the same as described for transfer operations, except that no memory or I/O read/write control signals will be generated, thus preventing the transfer of data. The 8257, however, will gain control of the system bus and will acknowledge the peripheral's DMA request for each DMA cycle. The peripheral can use these acknowledge signals to enable an internal access of each byte of a data block in order to execute some verification procedure, such as the accumulation of a CRC (Cyclic Redundancy Code) checkword. For example, a block of DMA verify cycles might follow a block of DMA read cycles (memory to peripheral) to allow the peripheral to verify its newly acquired data.

## Block Diagram Description

### 1. DMA Channels

The 8257 provides four separate DMA channels (labeled CH-0 to CH-3). Each channel includes two sixteen-bit registers: (1) a DMA address register, and (2) a terminal count register. Both registers must be initialized before a channel is enabled. The DMA address register is loaded with the address of the first memory location to be accessed. The value loaded into the low-order 14-bits of the terminal count register specifies the number of DMA cycles minus one before the Terminal Count (TC) output is activated. For instance, a terminal count of 0 would cause the TC output to be active in the first DMA cycle for that channel. In general, if N = the number of desired DMA cycles, load the value N-1 into the low-order 14-bits of the terminal count register. The most significant two bits of the terminal count register specify the type of DMA operation for that channel.

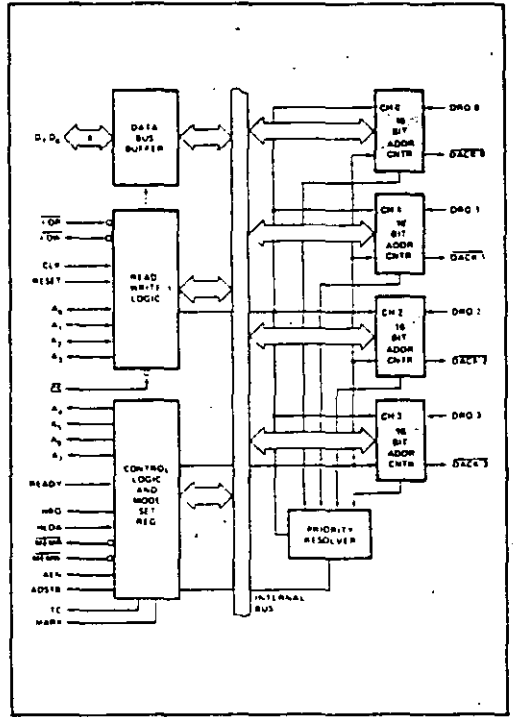

Figure 3. 8257 Block Diagram Showing DMA Channels



## 8259A/8259A-2/8259A-8 PROGRAMMABLE INTERRUPT CONTROLLER

- IAPX 86, IAPX 88 Compatible
- MCS-80<sup>s</sup>, MCS-85<sup>s</sup> Compatible
- Eight-Level Priority Controller
- Expandable to 64 Levels
- Programmable Interrupt Modes
- Individual Request Mask Capability
- Single +5V Supply (No Clocks)
- 28-Pin Dual-In-Line Package
- Available in EXPRESS
  - Standard Temperature Range
  - Extended Temperature Range

The Intel<sup>®</sup> 8259A Programmable Interrupt Controller handles up to eight vectored priority interrupts for the CPU. It is cascadable for up to 64 vectored priority interrupts without additional circuitry. It is packaged in a 28-pin DIP, uses NMOS technology and requires a single +5V supply. Circuitry is static, requiring no clock input.

The 8259A is designed to minimize the software and real time overhead in handling multi-level priority interrupts. It has several modes, permitting optimization for a variety of system requirements.

The 8259A is fully upward compatible with the Intel<sup>®</sup> 8259. Software originally written for the 8259 will operate the 8259A in all 8259 equivalent modes (MCS-80/85, Non-Buffered, Edge Triggered).

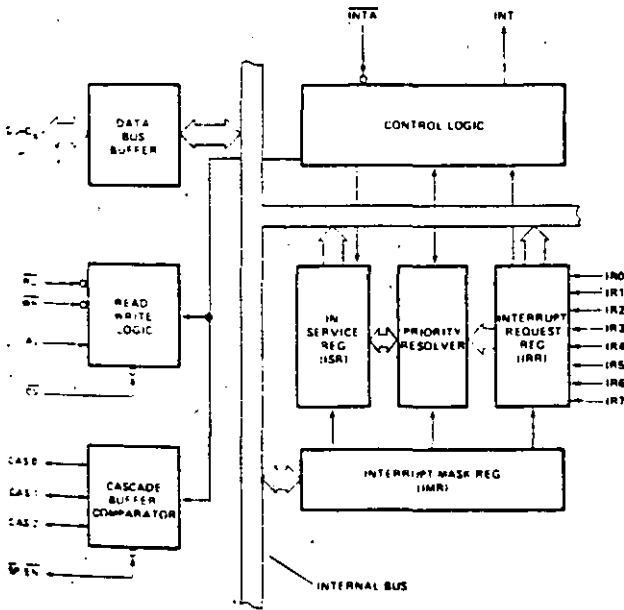

Figure 1. Block Diagram

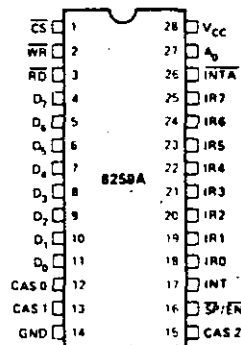
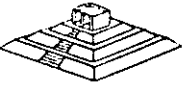

Figure 2. Pin Configuration



PERIFERICOS Y AJUSTES PRINCIPALES

# MONITOR DE VIDEO

*La creciente evolución de las microcomputadoras hace que la necesidad de monitores de video de buena calidad haya experimentado también un crecimiento significativo. Teniendo esto en cuenta, presentamos en este artículo un proyecto de Philips específico para este área, con todos los consejos de montaje y ajustes.*

*Proyecto: Philips Components  
Texto: Ing. David M. Risnik*

**E**l prototipo del monitor de video de alta resolución, probado por nosotros, funcionó en perfectas condiciones. Alertamos, sin embargo, que este montaje sólo está indicado para los técnicos experimentados en el tema del video.

Los problemas que pueden surgir en montajes de esta naturaleza se presentan bajo las más variadas formas y solamente quienes poseen las naturales vivencias en tal sector disponen de las habilidades necesarias para solucionarlos.

Los circuitos de alta tensión poseen un comportamiento típico de funcionamiento, y exigen conceptos prácticos para la solución de sus problemas.

Si bien por un lado consideramos que es un proyecto muy atractivo y satisfactorio para los que se dedican a este tema, creemos oportuno hacer esta aclaración para evitar trastornos a los lectores que no tengan la necesaria experiencia en el área. Recomendamos a todos, por otra parte, la lectura del artículo, que es muy didáctico.

El monitor de video puede considerarse el periférico de mayor importancia en una microcomputadora, y muchas veces se le confunde como parte integrante de la misma. Vamos entonces, antes de presentar su circuito, a

definir rápidamente sus características de funcionamiento.

Toda información a ser intercambiada entre el usuario y la micro debe estar dispuesta en la forma "inteligible" por el hombre, ya sea en forma de caracteres, símbolos o figuras (gráficos). Para satisfacer esta condición las señales digitales generadas por la microcomputadora son adaptadas para estimular determinados periféricos que trasladan esta información al hombre, en formas que él reconozca. Las impresoras y las terminales de video constituyen ejemplos típicos. En el caso de las impresoras, la información digital, creada especialmente para esta finalidad, se aplica a una cabeza de agujas que disparan sobre una cinta con tinta imprimiendo en el papel las letras, símbolos y dibujos.

En los terminales de video, se

desarrolla un proceso bastante semejante, pero con la ventaja de que no existen piezas mecánicas móviles (sujetas a desgaste) ni cintas con tinta, ni papel. Todo el proceso de impresión es electrónico: el papel es sustituido por la pantalla de un cinescopio, y el elemento "tinta", por la luz emitida resultante de la colisión entre el haz electrónico y la capa de fósforo que reviste internamente la cara plana de la pantalla (figura 1).

Los caracteres o gráficos creados digitalmente por la microcomputadora son transformados en una forma de señal (señal de video), que va a "modular" el haz electrónico en constante barrido por la pantalla del cinescopio, informando cuales son los puntos que deben ser iluminados (encendidos) o no.

¡Pero muchos de ustedes es-

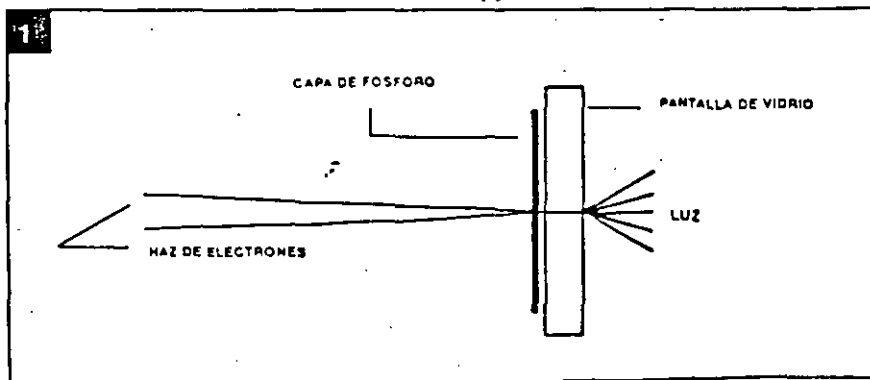

tarán preguntando si éste no es exactamente el proceso ejecutado por la televisión! Si, claro que si, con algunas diferencias que tienen como fin una mejor eficiencia. Veamos cuáles son estas pequeñas diferencias.

Las señales de video provistas por la computadora poseen características esencialmente digitales, o sea son solamente dos niveles para determinar el brillo de la pantalla:

- CERO (apagado = ausencia de brillo)
- UNO (encendido = brillo máximo)

En oposición a las señales analógicas que admiten infinitas tonalidades de gris, entre el brillo máximo y el negro (figura 2).

Una segunda diferencia importante reside en lo que definimos como "resolución". Vea que, a pesar de que una imagen de televisión nos parece continua, está en realidad constituida por una secuencia de puntos, unos al lado de otros, en la formación de una línea de video la imagen es formada por la sucesión de líneas de video. Cuanto mayor sea el número de puntos que forman una línea de video, tanto mayor será la "resolución" de esta imagen, o sea, la misma se vuelve más nítida.

En televisión, la resolución, o

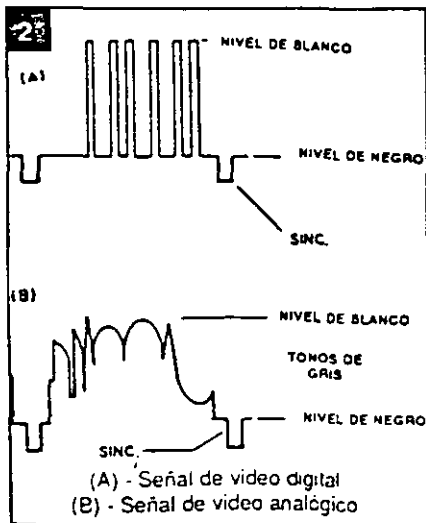

número de puntos de una línea de video, sufre limitaciones por el propio sistema de transmisión de esas imágenes (transmisión por radio frecuencia o RF), que limita la máxima frecuencia de video que se puede transmitir, dentro del sistema definido para un canal de televisión (figura 3).

¡En las microcomputadoras, esta limitación deja de existir, con lo que se pueden lograr definiciones bastante mayores! Una primera ventaja derivada de este hecho, es que podemos colocar en una línea de video un número mayor de caracteres (típico = 80 caracteres o más).

Una microcomputadora puede incluir una etapa moduladora de RF en su salida de video para permitir que esta señal alimente la entrada de antena de un receptor de TV convencional, y así operar como un terminal de video, naturalmente que con restricciones. En primer lugar, derivado solamente del proceso de esta modulación, agregamos a la señal de video una buena dosis innecesaria de ruido. Otro factor perjudicial en estos casos son los problemas derivados del proceso de sintonía de la señal, que pueden muchas veces perturbar y desestabilizar la imagen (interferencias por choques de señales). Y por último, la limitada resolución del receptor de TV, más el tratamiento analógico (etapa de salida de video) de una señal digital (de la microcomputadora), contribuyen a volver la imagen "nebulosa", con poca definición

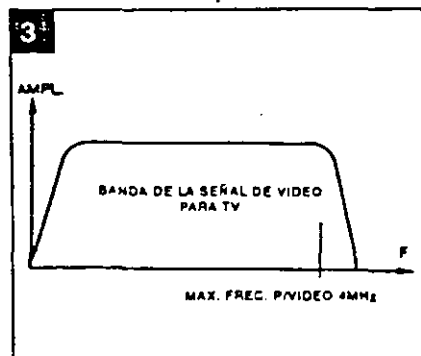

tanto para el texto como para los gráficos (figura 4).

Por todos estos factores, el uso de un monitor de video, diseñado especialmente para el tratamiento de señales digitales, es indiscutiblemente ventajoso para todos los sistemas de microcomputadoras.

### Requisitos de un monitor de alta resolución

¡Si intentamos reproducir una señal de audio de alta fidelidad (HI-FI) en un equipo de audio de bajos recursos, es evidente que no obtendremos una reproducción de alta fidelidad! Un sistema de audio de alta fidelidad debe ser constituido por amplificadores de buena calidad (respuesta en frecuencia) y "también" por cajas acústicas de buen desempeño.

Algo análogo exige el video. La señal de video de alta resolución proporcionada por la microcomputadora, solamente será reproducida a la perfección en un equipo de alta resolución, que incluya circuitos de buena calidad (respuesta en frecuencia y "también" cinescopio con capacidad para reproducciones de alta resolución).

Resaltamos por lo tanto que todos los integrantes de un sistema de alta resolución deben tener calificaciones compatibles de calidad.

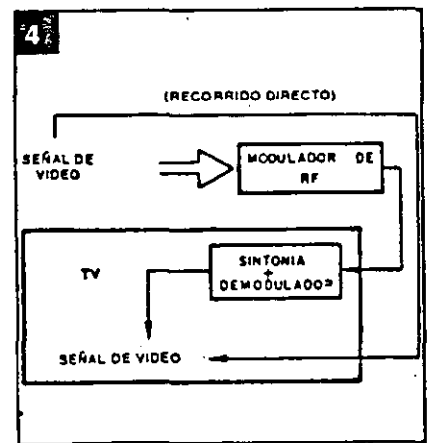



## El cinescopio

Un elemento de mucha importancia en el sistema de reproducción de video es sin duda alguna el "cinescopio" o tubo de rayos catódicos, ya que tiene la responsabilidad final de dar una buena imagen. Esta responsabilidad es todavía mayor cuando exigimos una resolución por encima del término medio aceptado en televisión. Vamos a analizar entonces cuáles son los pre-requisitos para obtener una buena resolución en la pantalla del cinescopio.

Como ya mencionamos, una imagen se forma mediante el agrupamiento de puntos en secuencia. A cada uno de estos puntos podemos llamarlo un "elemento de imagen". Por consiguiente, sabemos que cuanto mayor sea el número de elementos de imagen, mayor será la resolución de esta imagen.

En el trazado de una línea de video, los diversos elementos de imagen son yuxtapuestos uno a continuación del otro. Por deducción lógica, es fácil percibir que para una misma dimensión del cinescopio (ancho de la pantalla), cuanto más elementos de imagen quisiéramos colocar, tanto menores deberán ser los mismos.

El tamaño de un elemento de imagen es definido por el contorno de la emisión de luz que se forma en la posición de la colisión del haz electrónico con la pantalla. Este contorno puede ser considerado aproximadamente como un pequeño círculo. El tamaño de este círculo va a estar en proporción directa con el grosor del haz al chocar con la pantalla. Cuanto mayor fuera el grosor, mayor será el círculo, mayor será el elemento de imagen y por lo tanto se podrá distinguir un menor número de elementos de imagen en una línea de video. En esta condición, si intentamos colocar un número mayor de puntos, los mismos inevitable-

mente se superpondrán unos con otros, ¡produciendo no más puntos definidos, sino borrones! Ahí está la causa de la baja resolución (figura 5).

El control del grosor del haz electrónico al incidir sobre la pantalla del cinescopio está bajo la supervisión de la llamada "lente electrónica" en el cañón del cinescopio. Esta lente es responsable por el enfoque del haz sobre la superficie de la pantalla, muy semejante al enfoque de un haz de luz sobre una pared.

Cuanto mayor sea este enfoque más concentrado será el haz de electrones al chocar con la pantalla, y por lo tanto menor será el "punto" impreso.

Las lentes electrónicas en el interior del cañón del cinescopio están formadas por campos electrostáticos en una configuración tal que obligan a los electrones a converger al interior del haz. La correcta focalización del haz sobre la pantalla es obtenida por el ajuste de la tensión de alimentación de la rejilla de enfoque del cinescopio.

Los cinescopios de alta resolución poseen la configuración de esta lente electrónica de un modo especialmente diseñado, y exigen tensiones de polarización (de foco) bastante mayores (fig. 6).

### Enfoque uniforme

Muy bien, obtenido un buen enfoque del haz electrónico sobre

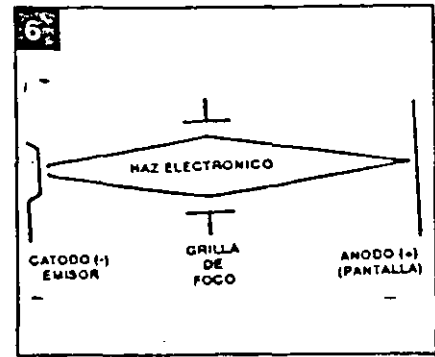

la pantalla, ¿nuestro monitor de video de alta resolución ya está delineado...? ¡Desgraciadamente todavía no! Falta solucionar un problemita relativo al enfoque: su uniformidad.

En virtud de la escasa curvatura de la pantalla, y de la pequeña distancia entre el centro de deflexión (posición del yugo) y la pantalla, el haz recorre una distancia diferente en función de su posición sobre la pantalla. En otras palabras, para alcanzar los bordes (cantos), el mismo debe recorrer una distancia mayor que la que recorre para alcanzar el centro de la pantalla. Esta distancia es bastante significativa en los cinescopios modernos, de gran ángulo de abertura (110 grados) (figura 7).

Los que trabajan con fotografía saben que el correcto enfoque de un objeto a 2 metros es diferente del correcto enfoque de otro objeto a 5 metros. El mismo problema se puede trasladar al cinescopio:

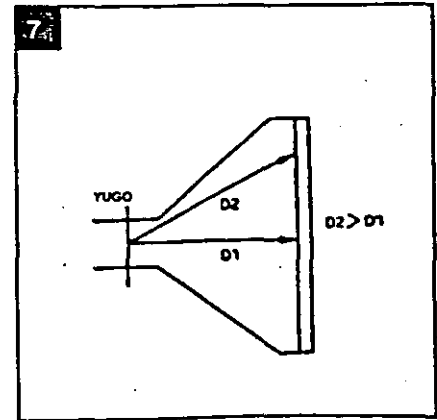
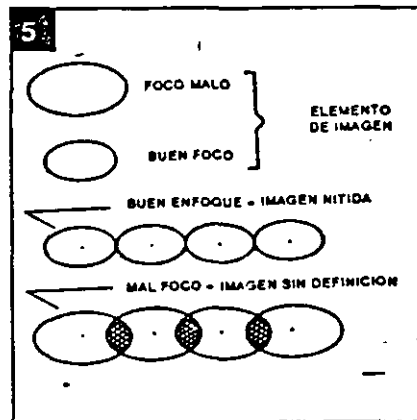

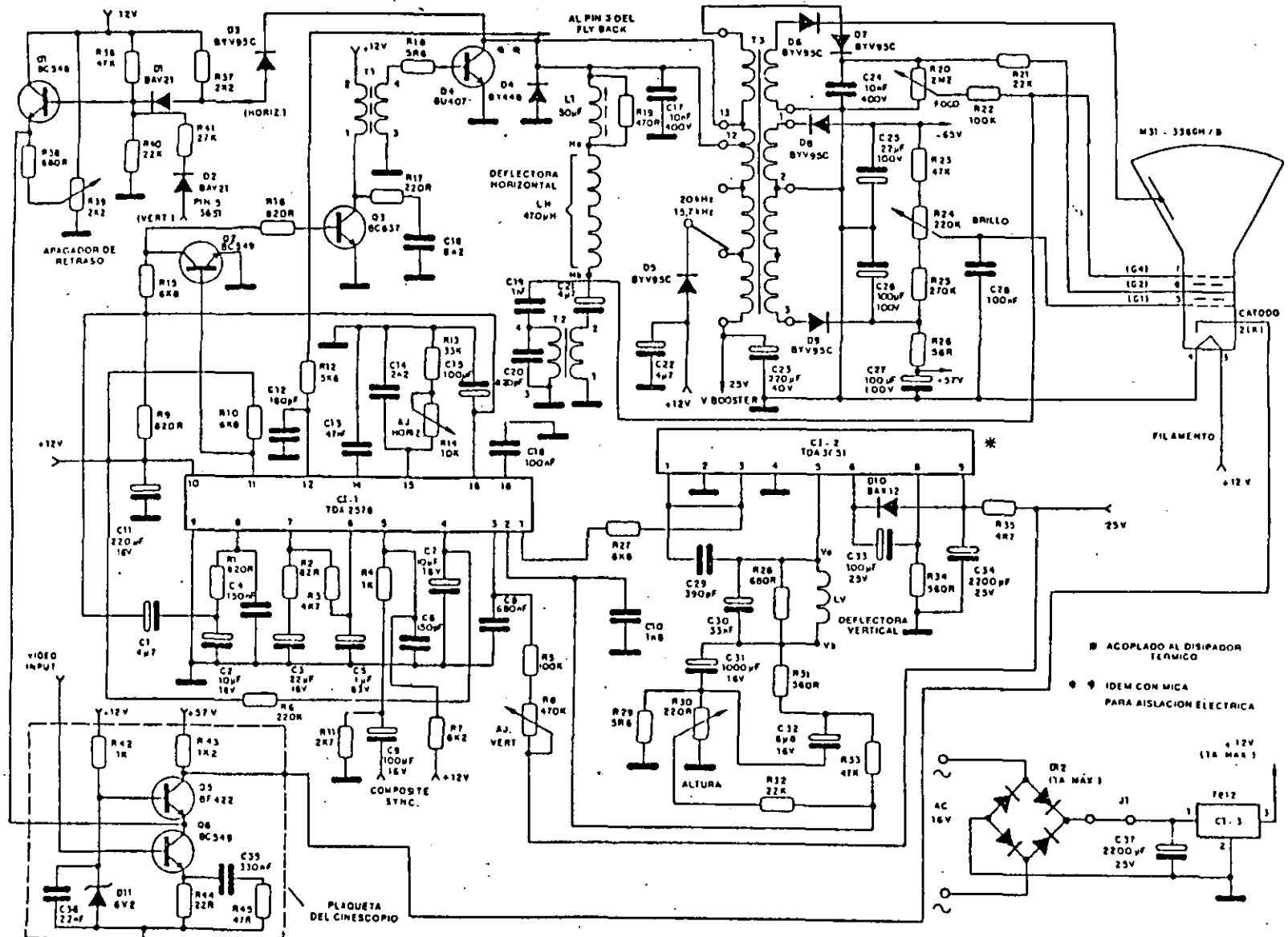

\* ACOPLO AL DISIPADOR TÈRMICO  
 ◆ IDEM CON MICA PARA AISLACION ELÈCTRICA

PLAQUETA DEL CINESCOPIO

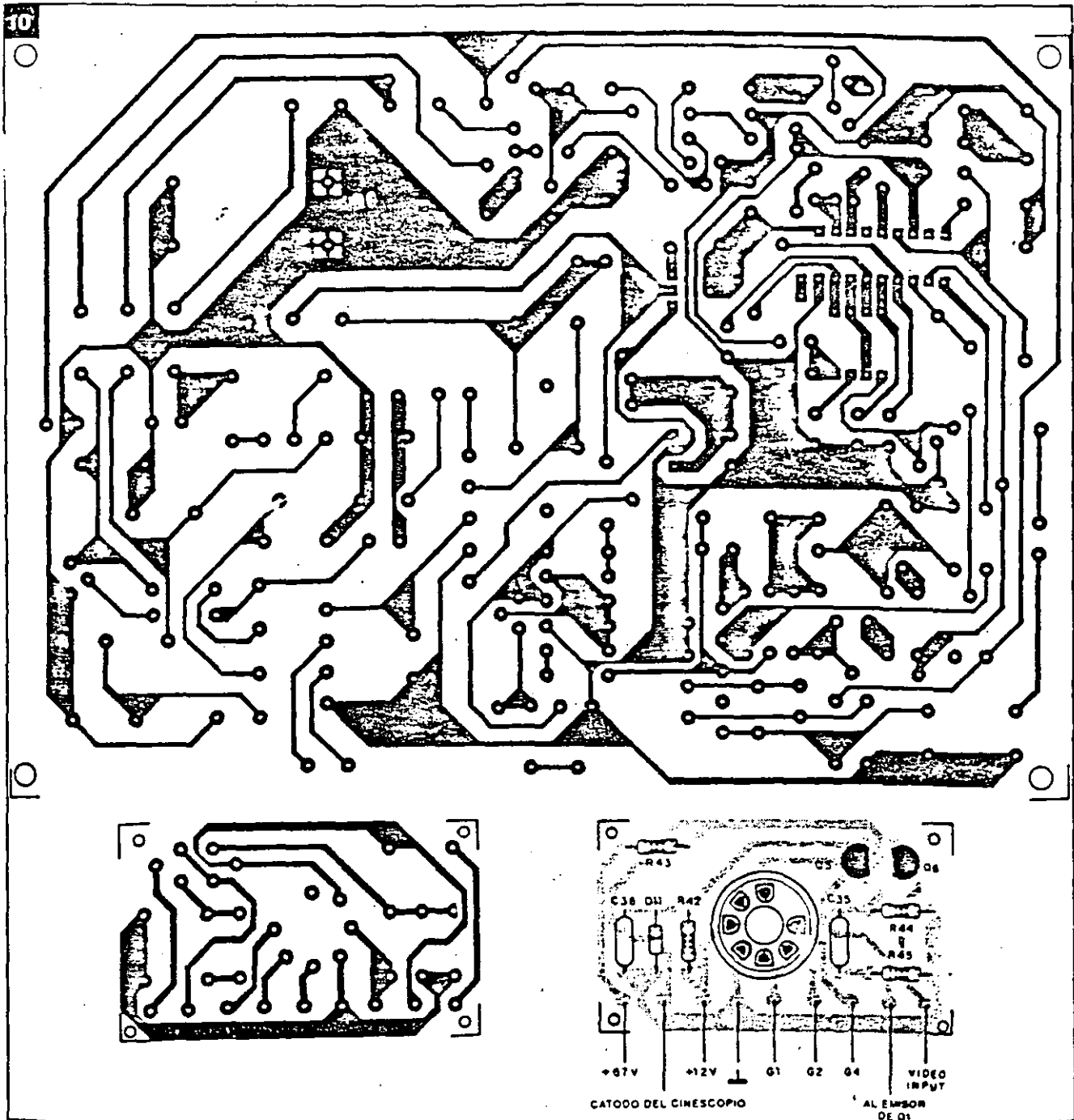

para alimentar los demás elementos del cinescopio y la etapa de salida vertical (=25V).

### Montaje

El circuito del monitor de video está compuesto por dos módulos: la placa principal y la plaqueta

de cinescopio. La fuente de alimentación, con excepción del transformador de fuerza, se sitúa en la propia placa base. Los diseños de estas dos placas aparecen en la figura 10.

El montaje de la placa principal es sin duda lo que requiere

mayores cuidados, y para el mismo elaboramos una secuencia que facilitará esa tarea.

Inicie el montaje por los componentes menores (más livianos), redoblando su atención cuando sean del tipo "polarizado" como por ejemplo capacitores elec-

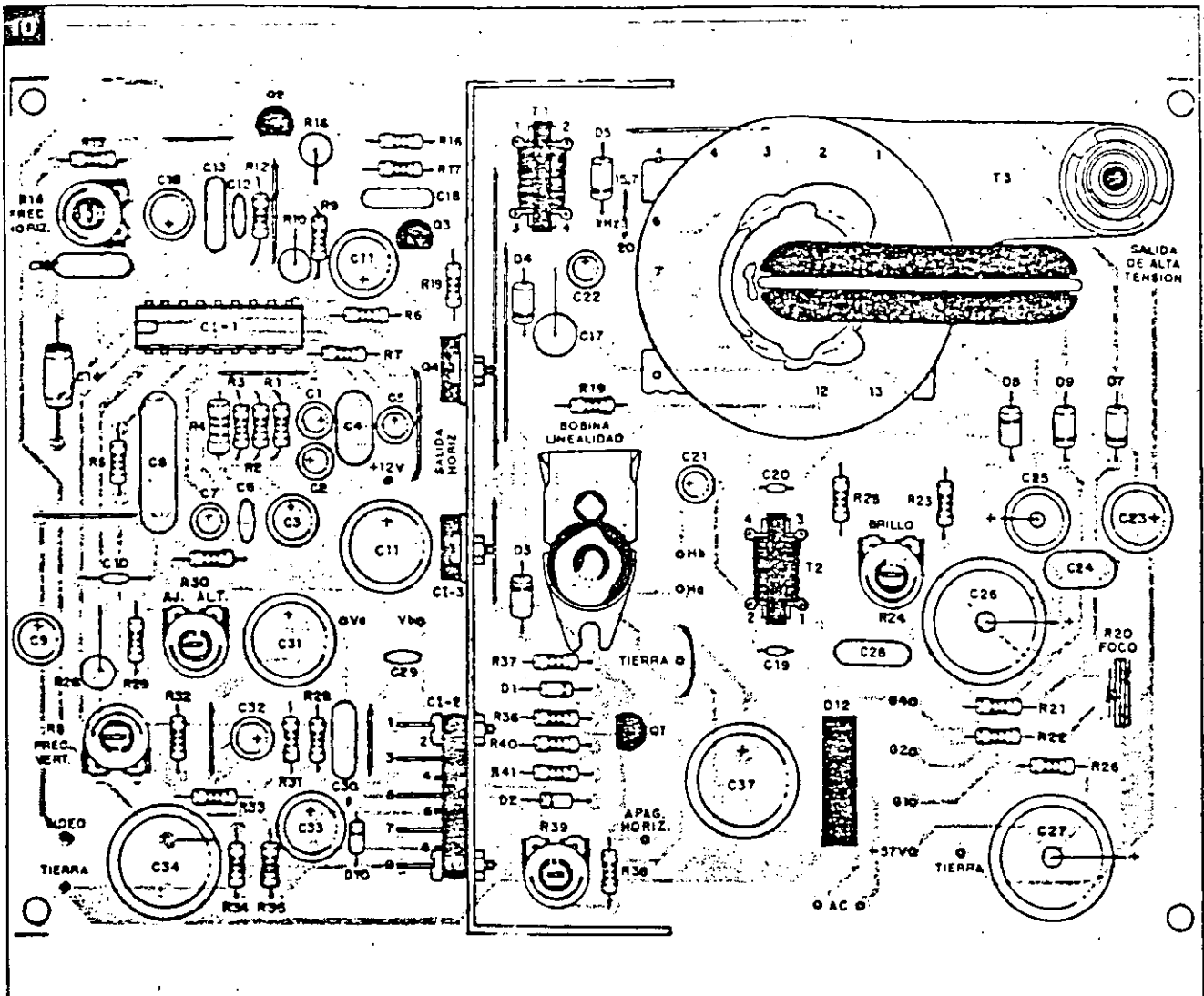

trolíticos, diodos y transistores. Observe la indicación de su polaridad en la placa y asegúrese que está correcta antes de soldarlo.

Recuerde también colocar todos los jumpers necesarios.

Estos jumpers deben ser trozos de alambre 22 AWG (diámetro en mm 0.6438) rígido o flexible.

Si usted fuera a operar con equipos de 525/2 líneas la frecuencia horizontal deberá ser de 15.75 kHz.

Seleccione el jumper apropiado (diodo D5 alimentando el pin 4 del Fly-Back). La otra posición (diodo D5 alimentando el pin 5 del Fly-Back) permite la operación con frecuencia horizontal de 20kHz.

Para facilitar la prueba de esta placa principal, es conveniente

subdividirla en dos etapas básicas: la de baja tensión y la de alta tensión (etapa de salida horizontal).

### Montaje de la primera etapa

En el montaje de esta primera etapa, **NO COLOQUE EN EL CIRCUITO LOS SIGUIENTES COMPONENTES:**

- el transformador de salida horizontal (T3) (fly-back)
- el transistor de salida horizontal (Q4)
- el CI-2 (salida vertical)
- la bobina de linealidad

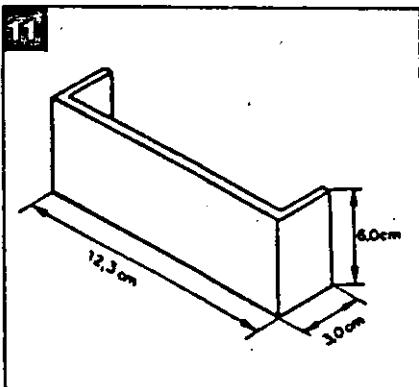

- el transistor drive (Q3)

Por ser estos componentes mayores y más pesados, y dado que no contribuyen a la prueba de funcionamiento de esta primera etapa, el manejo de la placa sin ellos se vuelve más fácil, y al mismo tiempo evita cualquier tipo de accidente (el núcleo del fly-back y de la bobina de linealidad no deben sufrir impactos mecánicos, a riesgo de partirse).

El disipador de aluminio (figura 11), soporte térmico de Q4 (salida horizontal), CI-2 (salida vertical), y CI-3 (regulador de la fuente), también pueden dejarse de lado en esta primera etapa, a menos que usted opte por usar la propia fuente de alimentación del circuito en la prueba. Recomendamos el uso de una fuente regulada externa, con ajuste progresivo de tensión (6 a 12V). Los transformadores T1 (drive) y T2 (foco dinámico) no entrarán en funcionamiento en esta primera etapa, pero pueden montarse en la placa. Atención a la numeración de los pins de estos transformadores; evite colocarlos invertidos (primario y secundario).

### Primera prueba de funcionamiento

Con la placa principal montada (a excepción de los componentes descritos más arriba), inspeccione lentamente el conjunto, en busca de irregularidades: controle la posición de los componentes, la polaridad de los diodos y capacitores electrolíticos, y verifique si no existen cortos accidentales provocados por corrimientos de soldadura o terminales doblados. Recuerde si no falta ninguno de los jumpers. En caso de duda, siga las conexiones con el esquema eléctrico.

En esta primera prueba verificaremos la correcta operación del oscilador horizontal (CI-1), y para ello, no hay necesidad de colocar ni la plaqueta del cines-

copio ni el yugo de deflexión, ni el TRC.

Coloque la placa montada y revisada en el banco de trabajo y aliméntela con una fuente auxiliar de 12V. Es conveniente aplicar la tensión de alimentación en modo creciente, monitorizando con un osciloscopio la salida de señal por el pin 11. La figura 12 muestra la forma de onda que deberá estar presente allí. Cualquier irregularidad, vuelva a inspeccionar la placa, desconectando la fuente de alimentación. Debe ser considerado normal un pequeño calentamiento de este circuito integrado (CI-1).

La resistencia R9, de 820 Ω, alimenta el pin 16 proporcionando la corriente mínima para la partida del oscilador (start). La resistencia R12 alimenta el pin 12 con pulsos horizontales (retroalimentación) para efecto de control de la frecuencia (sincronismo). Es conveniente levantarlo en esta primera etapa de prueba, para evitar que bloquee el arranque, una vez que la etapa de salida está inoperante. No es común que aparezcan problemas en esta prueba inicial. No es necesario inyectar ninguna señal de entrada.

Estando todo en orden, verifique también el ajuste de la frecuencia horizontal R14, girándolo para un lado y el otro, observando en el osciloscopio la variación de la frecuencia de la señal de salida, manténgalo en la posición en que obtenga la frecuencia horizontal correcta de 15,75kHz (periodo de 63µs). Más tarde se

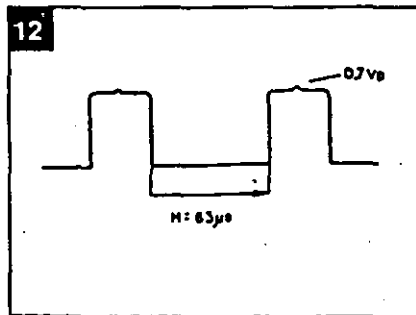

deberá retocar este ajuste.

Acuérdese de solucionar los problemas por etapas, que resulta mucho más simple y racional que intentar solucionarlos como un todo.

### Montaje de la segunda etapa

Coloque ahora el resto del material para completar el montaje de la placa principal.

Al disipador de aluminio en forma de "U" se acoplarán el transistor de salida horizontal (con mica de aislamiento), el regulador de la fuente de 12V y el CI de salida vertical. Solamente el transistor de salida horizontal exige aislar de su colector con la tierra del disipador.

Realice ahora el montaje de la placa del cinescopio. La disposición de las terminales de los transistores está esbozada en la figura 13. Atención al soldar el soquet del cinescopio en la plaqueta. En él existe un pin vacío (sin agujero) que sirve de guía al enchufarlo en los pins del cinescopio. Verifique su posición para que coincida con las conexiones a los elementos del tubo. Una buena referencia son los pins de filamento (3/4). Para localizarlos en el tubo, puede usar un ohmímetro y verificar la baja resistencia entre ellos.

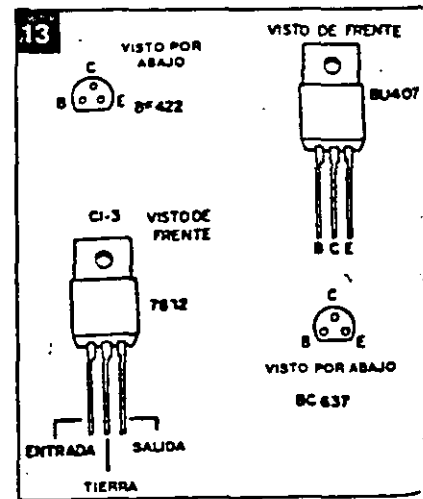

Las conexiones entre la placa del cinescopio y la placa base deberán ser de una extensión suficiente para que concuerden con la disposición mecánica final. Estas conexiones son: la rejilla de foco (pin 7), la rejilla auxiliar G2 (pin 6), la rejilla de control G1 o de brüllo (pin 5), el cátodo (pin 2), la tierra (pin 4), filamento +12V (pin 3) y finalmente la alimentación para el transistor de salida de video +57V en la placa. La tierra de la placa del cinescopio deberá también ser conectada a la tierra del cinescopio (aquadac), como muestra la figura 14.

Las conexiones del yugo también deberán hacerse: bobinas deflectoras horizontales (dos alambres) y bobinas deflectoras verticales (dos alambres). Observe por la figura 15 la disposición de los terminales del yugo. En estas conexiones, mantenga también una extensión suficiente conforme se explicó anteriormente.

Por fin, la conexión del transformador de alimentación: la entrada alternada del secundario de 18V del transformador va a alimentar la placa principal, donde será rectificadada y filtrada, yendo a alimentar el regulador de 12V.

**Prueba final**

En esta etapa de prueba final, todos los circuitos del monitor deberán entrar en funcionamiento, y por lo tanto, como se

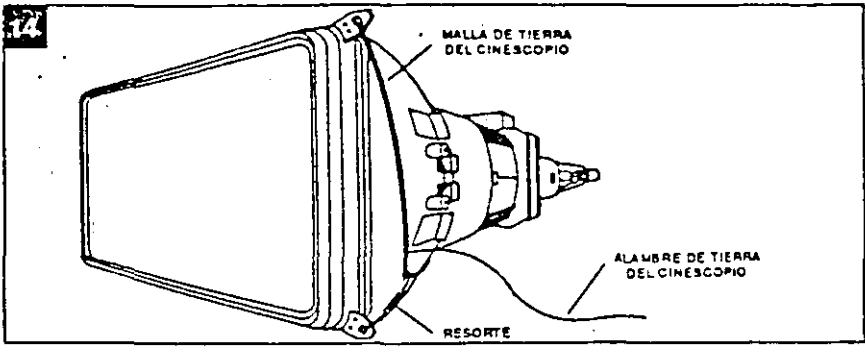
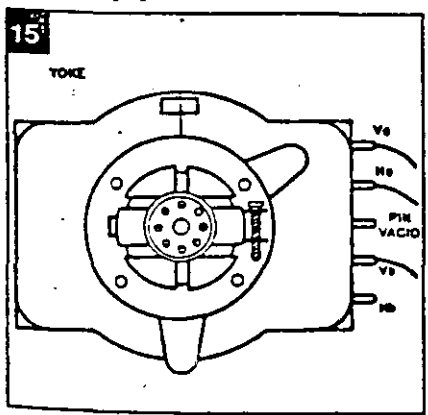

puede esperar, la probabilidad de que ocurran problemas también son mayores, y debemos estar preparados para resolverlos. En este sentido elaboramos una tabla con las principales formas de onda en el circuito, para que sirvan de referencia en su trabajo (figura 16).

Consiga un osciloscopio y una fuente de alimentación ajustable para dar principio a los trabajos finales.

Siempre recomendamos que preferentemente se use una fuente de alimentación externa (12V x 1A) hasta que coloque el circuito en pleno funcionamiento.

**Consideraciones y consejos**

a) El yugo es la carga de las etapas horizontal y vertical, por lo tanto cualquier irregularidad en su conexión influirá sobre estas etapas. Revise con cuidado las conexiones de las bobinas horizontales (Ha y Hb) y verticales (Va y Vb) al circuito. En caso de duda, con un ohmetro puede fácilmente localizar las bobinas de deflexión vertical pues las mismas presentarán una resistencia bastante superior (del orden de 12 ohm) comparada a la de las bobinas deflectoras horizontales. El bobinado de la deflexión vertical se hace sobre el núcleo de ferrita del yugo, pues este bobinado exige una inductancia alta, para hacer carga a los 50Hz ó 60Hz de la deflexión vertical. Jamás conecte el circuito sin que la

conexión del yugo esté hecha.

b) Use un osciloscopio con entrada para hasta 400V. La lectura de los pulsos horizontales creados en el colector del transistor de salida horizontal puede alcanzar de 250 a 300V de pico. Para efectuar esta lectura el osciloscopio debe permitir la entrada de tensiones de este orden.

c) El chupón del cinescopio conduce la "muy alta tensión" necesaria al ánodo para que el haz de electrones sea atraído hacia la pantalla. Sin esta MAT, aunque el resto del circuito esté funcionando, no habrá brillo en la pantalla. **En ningún caso proceda a la lectura de esta MAT (del orden de 13kV) ya sea con voltímetro o con osciloscopio.**

d) Mucho cuidado al manipular el cinescopio. Su parte más delicada y frágil es el "cuello". Jamás cargue el cinescopio solamente por este "cuello". Sosténgalo siempre por la cara exterior

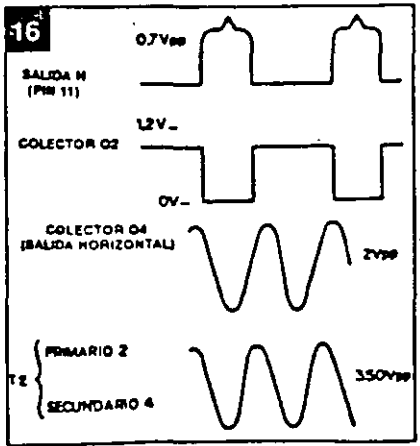

de la pantalla.

e) El ánodo del cinescopio (cara interna que reviste el tubo) forma un capacitor con la faz externa de grafito. Asegúrese de que este capacitor esté descargado durante la manipulación del cinescopio. Puede producirse su descarga por un corto resistivo (10k) entre el ánodo y el grafito o tierra del tubo. Evite cortes desagradables y accidentes inesperados.

f) El comportamiento del cinescopio es muy semejante al de una de las "viejas" válvulas.

El brillo de la pantalla es el resultado del pasaje del haz de electrones entre el cátodo (emisor) y el ánodo (receptor). Por lo tanto, son condiciones esenciales para tener el brillo de la pantalla: filamento caliente, tensión de aceleración en el ánodo (MAT), polarización adecuada en los demás elementos como el cátodo, rejilla de control, rejilla auxiliar y rejilla de foco.

g) Como las fuentes auxiliares son generadas por los secundarios del "fly-back" cualquier consumo de estas fuentes que esté por encima de lo normal (por ejemplo, cortocircuitos) se reflejará como dificultad de desempeño del transistor de salida horizontal, pues es él quien provee toda la energía de este sistema. La etapa vertical es alimentada por la tensión de +25V generada en el pin 5 del fly-back. Si por ejemplo el CI-2 estuviera con un consumo exagerado o en corto, el drenaje de corriente de esta fuente auxiliar bloqueará la salida horizontal.

h) Si ocurriera algún tipo de problema en la etapa horizontal, es normal que las tensiones auxiliares no se presenten en sus valores correctos. Por lo tanto, en estos casos, procure solucionar el problema principal, y no tome como referencia estas tensiones auxiliares, que volverán a lo nor-

mal en cuanto se resuelva la anomalía.

### Ajustes del monitor

Son necesarios los siguientes ajustes, después que el aparato esté funcionando normalmente:

- **Frecuencia horizontal:** determina la frecuencia libre del oscilador horizontal que debe ser igual o muy cercana a la frecuencia de uso.

Sin ninguna señal aplicada a la entrada de video, ajuste por R14 la frecuencia de 15,75kHz en la señal de salida del pin 11 de CI-1. Conecte una señal de video y verifique la correcta sincronía de la imagen en la pantalla. Si fuera necesario, se pueden hacer pequeños retoques con la imagen en la pantalla.

- **Frecuencia vertical:** procedimiento idéntico con relación al osciloscopio vertical. Con una imagen en la pantalla, ajuste mediante R8 hasta conseguir su

## CIRCUITOS & INFORMACIONES

### CONVERSOR LUZ/FRECUENCIA

Este circuito proporciona una señal de salida cuya frecuencia depende de la intensidad de la luz que incide en un elemento sensible, en este caso un LDR.

La forma de la onda obtenida puede ser en diente de sierra, como pulsos bien agudos, según el electrodo del transistor de donde parta. En el emisor del transistor unijuntura tenemos una forma de onda diente de sierra y en la base de B1 tenemos pulsos agudos de buena intensidad.

El circuito es un oscilador de relajación donde la constante de

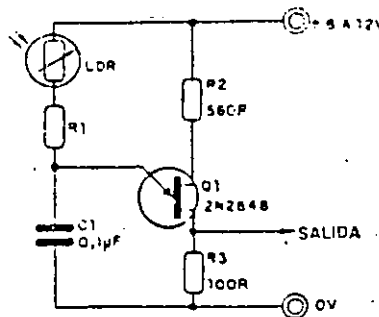

tiempo RC es variable, ya que R representa la resistencia del LDR, que es función de la luz incidente.

En la figura se ve el circuito simple que puede alimentarse con tensiones entre 6 y 12V.

La banda de frecuencias para el circuito está entre 100Hz y 5kHz pero puede modificarse cambiando C1. Valores mayores disminuyen las frecuencias de la banda.

El transistor unijuntura aconsejado es el 2N2646 aunque pueden probarse equivalentes.

Una aplicación posible de este circuito está en el desarrollo de un fotómetro digital.

ajustación vertical.

• **Altura vertical:** ajusta la ganancia del camino vertical de la señal de deflexión, y por consiguiente, la altura de la imagen en la pantalla. Su ajuste puede realizarse con una imagen que llene todo el contorno de la pantalla (por ejemplo un patrón blanco). Actúe sobre el trimpot hasta conseguir la altura deseada. En monitores de computadora, se recomienda una altura de 3/4 de la pantalla, o la preferencia del usuario.

• **Control de brillo:** el trimpot R24 ajusta la tensión de polari-

zación de la rejilla de control del cinescopio, y por lo tanto determina el punto de corte para el pasaje del haz de electrones. El ajuste del brillo debe permitir que solamente sean visibles las letras o puntos gráficos de la computadora, y no un fondo claro.

• **Ajuste de foco:** como el propio nombre lo dice, obtendrá un punto óptimo de focalización del haz sobre la pantalla. Use una imagen con bastantes detalles gráficos para una mejor apreciación de este ajuste.

• **Ajuste de apagado:** el trim-

pot R39 ajusta el límite de apagado horizontal y vertical, o sea, para que el retorno del haz no sea visible en la pantalla. Este ajuste se hace observando hasta que la imagen permanezca agradable, sin sombras ni nubes, y sin líneas de retraso vertical. La señal de video debe ser conectada a la entrada.

• **Ganancia de video:** en función del nivel de señal de video a ser aplicado al amplificador de la placa del cinescopio, podrá ser necesario sustituir la resistencia R45 que determina la ganancia de la etapa.

#### LISTA DE MATERIALES

##### Resistores

R01 - 820R  
R02 - 82R  
R03 - 4k7  
R04 - 1k  
R05 - 100k  
R06 - 220k  
R07 - 8k2  
R08 - 470k (TP)  
R09 - 820R  
R10 - 6k8  
R11 - 2k7  
R12 - 5k6  
R13 - 33k  
R14 - 10k (TP)  
R15 - 6k8  
R16 - 820R  
R17 - 220R  
R18 - 5R6  
R19 - 470R  
R20 - 2M2 (TP)  
R21 - 22k  
R22 - 100k  
R23 - 47k  
R24 - 220k (TP)  
R25 - 270k  
R26 - 56R  
R27 - 6k8  
R28 - 680R  
R29 - 5R6  
R30 - 220k (TP)  
R31 - 560R  
R32 - 22k

R33 - 47k

R34 - 560R

R35 - 4R7

R36 - 47k

R37 - 2k2

R38 - 680R

R39 - 2k2

R40 - 22k

R41 - 27k

R42 - 1k

R43 - 1k2

R44 - 22R\*

R45 - 47R

TP = mini trimpot

\* ajusta la ganancia de video

##### Capacitores:

C01 - 4 $\mu$ 7/16V (EL)  
C02 - 10 $\mu$ /16V (EL)  
C03 - 22 $\mu$ /16V (EL)  
C04 - 150n/63V (CR)  
C05 - 1 $\mu$ /63V (EL)  
C06 - 150p/50V (CR)  
C07 - 10 $\mu$ /16V (EL)  
C08 - 680n/50V (CR)  
C09 - 100 $\mu$ /16V (EL)  
C10 - 1n8/50V (CR)  
C11 - 220 $\mu$ /16V (EL)  
C12 - 180p/63V (CR)  
C13 - 47n/250V (PL)  
C14 - 2n2/100V (ST)  
C15 - 100 $\mu$ /16V (EL)

C16 - 100n/250V (PL)

C17 - 10n/400V (PL)

C18 - 8n2/250V (PL)

C19 - 1n/50V (CR)

C20 - 820p/50V (CR)

C21 - 4 $\mu$ 7/16V (EL)

C22 - 4 $\mu$ 7/16V (EL)

C23 - 220 $\mu$ /40V (EL)

C24 - 10n/600V (PL)

C25 - 22 $\mu$ /100V (EL)

C26 - 100 $\mu$ /100V (EL)

C27 - 100 $\mu$ /100V (EL)

C28 - 100n/250V (PL)

C29 - 390p/50V (CR)

C30 - 33n/250VOP (PL)

C31 - 1000 $\mu$ /16V (EL)

C32 - 6 $\mu$ 8/16V (EL)

C33 - 100 $\mu$ /25V (EL)

C34 - 2200 $\mu$ /25V (EL)

C35 - 330n/250V (PL)

C36 - 22n/250V (PL)

C37 - 2200 $\mu$ /25V (EL)

CR = cerámico

PL = poliéster

EL = electrolítico

ST = styroflex

##### Diodos:

D1, D2 - BAV21

D3, D5 a D9 - BYV95C

D4 - BY206 ó BY448

D10 - BAX12

D11 - zener 6V2

D12 - puente rectificador

##### Transistores

Q1 - BC548

Q2, Q5 - BC549

Q3 - BC637

Q4 - BU407

Q5 - BF422

Varios: cinescopio 12"

(31 cm) Philips M31

336 GH/B, unidad

deflectora (yoke)

Philips 3106 108 6777,

transformador salida

horizontal (fly-back)

Philips 3106 108 3167,

bobina de linealidad

Philips 3106 108 2660,

transformador drive

(T1) 1171, transformador

para foco

dinámico (T2) 31681,

zócalo para

cinescopio 7 pins,

zócalo para CI 18 pins,

transformador de

fuerza con secundario

de 18V, cordón de

fuerza, placa de cir-

cuito impreso base,

plaqueta de

cinescopio, etc



# Unidades de Disco Flexible

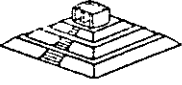

## Ajustes Principales

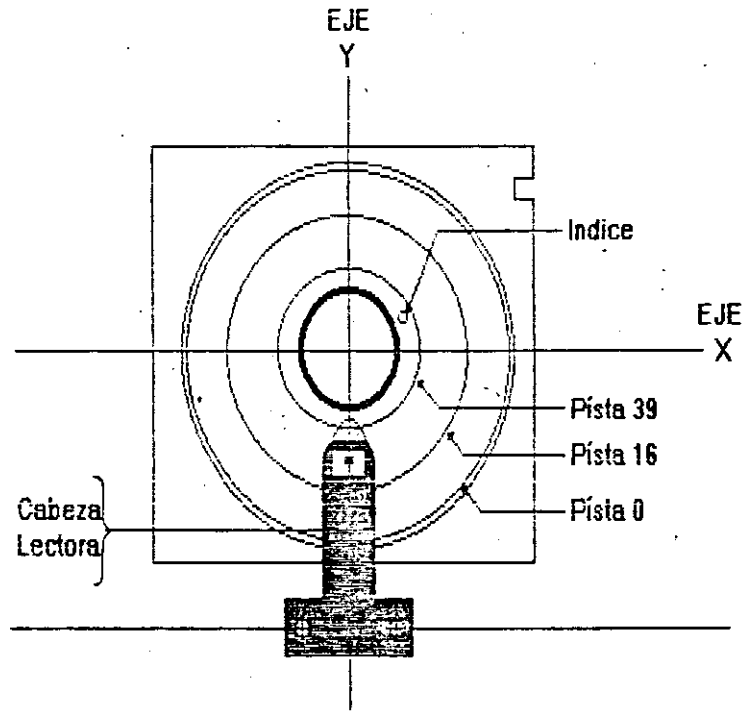

apuntes

# UNIDADES DE DISCO



IBM Personal Computer  
 Drive Diagnostic Program

Version 1.00  
 Copyright Dyan Corp. 1983

- A. Automatic Drive Tests
- B. Manual Drive Tests
- C. Diskette Utilities

Enter command (A - C):

Dr: A Trk: 0 Side: 0 Rtrys: 0 Seek: 6 Settle: 15 DS Sound

# UNIDADES DE DISCO

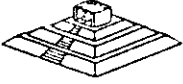

## Drive Set-Up

Enter Drive number (A - D):

Enter Seek Time  
(2, 4, 6, 8, ... 32 msec.):

Enter Head Settle Time (0 to 50 msec.):

Enter Retries (0 to 20):

Single / Double Sided (S/D):

Sound - Yes/No (Y/N):

Dr: A Trk: 0 Side: 0 Rtrys: 0 Seek: 6 Settle: 15 DS Sound

apuntes

# UNIDADES DE DISCO

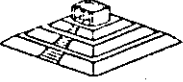

----- Automatic Tests -----

	Side 0	Side 1
RPM:	300	
Centering: Track 21	ok	ok
Radial: Track 0	-13 +13 [+0]	-13 +13 [+0]
16	-13 +13 [+0]	-13 +13 [+0]
39	-13 +13 [+0]	-13 +13 [+0]
Azimuth: Track 34	-42 +42	-42 +42

Number of Passes = 1      \*\*\* Drive PASSED All Tests \*\*\*

- Press S Key - Stop Test at End of Current Pass
- Press Esc - Exit to Automatic Test Menu
- Press P Key - Print Screen
- Press Any Other Key to Restart Test

Dr: A Trk: 34 Side: 1 Rtrys: 0 Seek: 6 Settle: 15 DS Sound

# UNIDADES DE DISCO

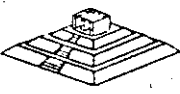

## Manual Test Menu

- |                         |                              |
|-------------------------|------------------------------|
| A. Setup Drive          | I. Random Seek, Read & Write |
| * B. RPM                | J. Track Seek                |
| * C. Diskette Centering | K. Alternate Track Seek      |
| * D. Radial Alignment   | L. Last Disk Error Status    |
| * E. Azimuth Alignment  | M. Select Side 0             |
| * F. Hysteresis         | N. Select Side 1             |
| G. Accordion Seek       | Z. Main Menu                 |
| H. Random Seek & Read   |                              |

Enter command (A - Z):

Dr: A Trk: 0 Side: 0 Rtrys: 0 Seek: 6 Settle: 15 DS Sound

apuntes

# UNIDADES DE DISCO

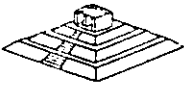

## Radial Alignment

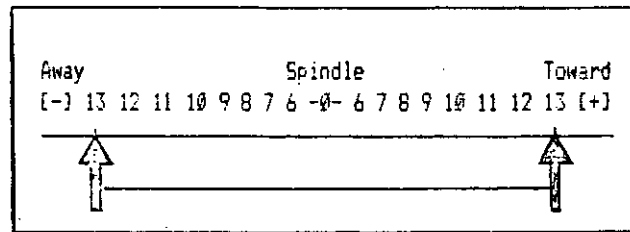

Press Esc - Exit To Menu  
 Press Any Key - Restart Test

Dr: A Trk: 19 Side: 0 Rtrys: 0 Seek: 6 Settle: 15 DG Sound

apuntas

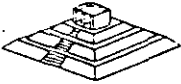

6- MANTENIMIENTO CORRECTIVO  
BASICO - MEDIO

# Puerto Teclado



(A)

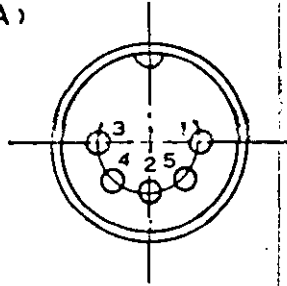

(B)

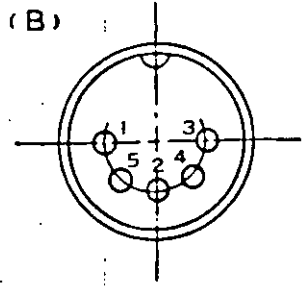

A: Keyboard 5-pin connector

B: Main board 5-pin connector

5 PIN DIN Connector

PIN	SIGNAL
1	+Keyboard Clock
2	+Keyboard Data
3	-Keyboard Reset
4	Ground
5	+5 Volts

apuntes



# Configuración puertos



## PORTS PINS - OUT SERIAL PORT (J1, J2)

Pin	Signal	Pin	Signal
1	Carrier Detect	6	Data Set Ready
2	Received Data	7	Request to Send
3	Transmitted Data	8	Clear to Send
4	Data Terminal Ready	9	Ring Indicator
5	Signal Ground	10	

## MOUSE PORT (J5)

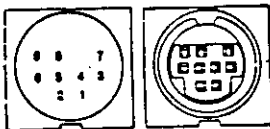

Pin	Signal
1	+5V
2	XA
3	XB
4	YA
5	YB
6	LB
7	MB
8	RB
9	GROUND

## GAME PORT (J3)

Pin	Signal	Pin	Signal
1	+5V	9	+5V
2	D4	10	D6
3	D0	11	D2
4	Ground	12	Ground
5	Ground	13	D3
6	D1	14	D7
7	D5	15	+5V
8	+5V	16	Ground

## apuntes

# Señales de Video

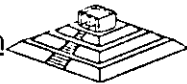

AT STANDARD TTL LEVELS

RGB COLOR MONITOR	Ground	1	COLOR GRAPHICS ADAPTER
	Ground	2	
	Red	3	
	Green	4	
	Blue	5	
	Intensity	6	
	Reserved	7	
	Horizontal Drive	8	
	Vertical Drive	9	

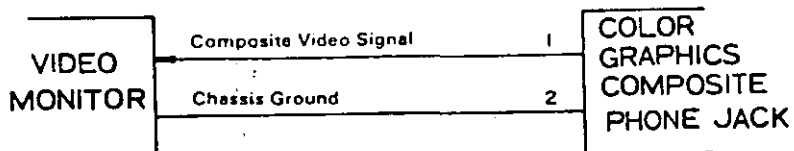
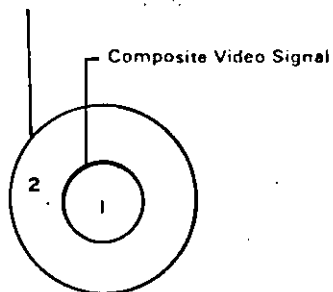

apuntes

# Interface Disco Duro



## HARDDISK DRIVE INTERFACE (J7)

Pin	Signal	Pin	Signal
1	Reset	2	Ground
3	D 7	4	D8
5	D6	6	D9
7	D5	8	D10
9	D4	10	D11
11	D3	12	D12
13	D2	14	D13
15	D1	16	D14
17	D0	18	D15
19	Ground	20	Un used
21	Unsued	22	Ground
23	IOW	24	Ground
25	IOR	26	Ground
27	IOCHRDY	28	ALE
29	Unsed	30	Ground
30	IRQBUS	32	JOCS16
33	A1	34	Unsued
35	A0	36	A2
37	CS0	38	CS1
39	SLV ACT	40	Ground

apuntes

This Card is produced by auto-equipment. If there is any problem, you can send it to us.

# Interface Unidades de Disco Flexible

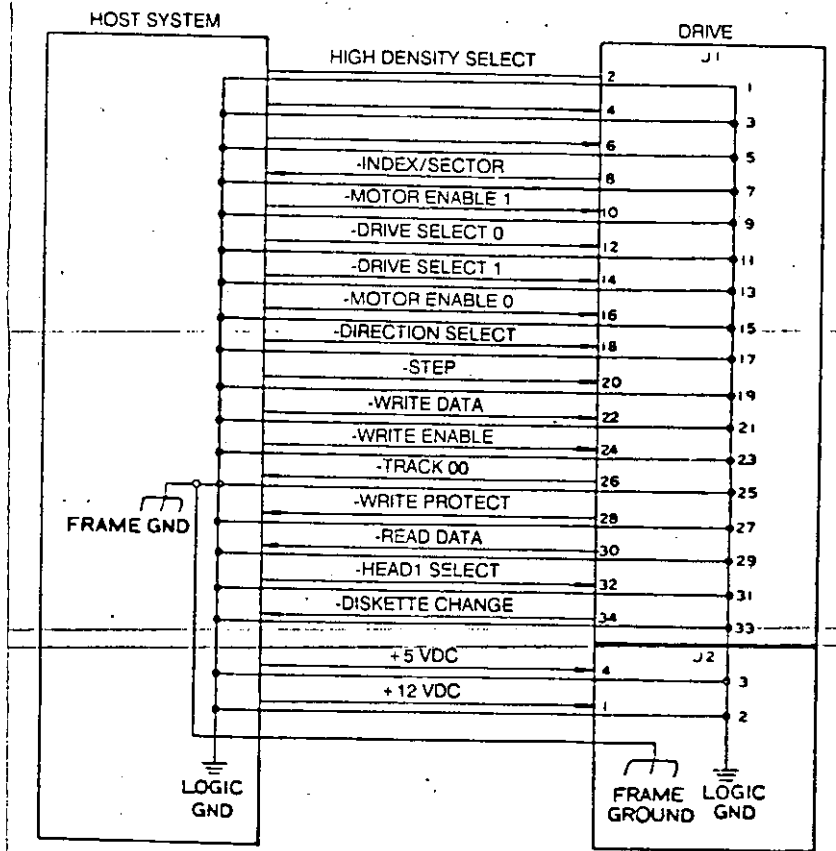

INTERFACE CONNECTIONS

apuntes

# Puerto RS232 (serial)



PERIPHERAL	Description	Pin No.	RS232 PORT
	NC	1	
	Transmitted Data	2	
	Received Data	3	
	Request to Send	4	
	Clear to Send	5	
	Data Set Ready	6	
	Signal Ground	7	
	Carrier Detect	8	
	NC	9	
	NC	10	
	NC	11	
	NC	12	
	NC	13	
	NC	14	
	NC	15	
	NC	16	
	NC	17	
	NC	18	
	NC	19	
	Data Terminal Ready	20	
	NC	21	
	Ring Indicator	22	
	NC	23	
	NC	24	
	NC	25	

apuntes

# Interface "Centronics" (paralelo)



25 PIN Connector		36 PIN Connector	
PIN	SIGNAL	PIN	SIGNAL
1	STROBE	1	STROBE
2	DATA 1	2	DATA 1
3	DATA 2	3	DATA 2
4	DATA 3	4	DATA 3
5	DATA 4	5	DATA 4
6	DATA 5	6	DATA 5
7	DATA 6	7	DATA 6
8	DATA 7	8	DATA 7
9	DATA 8	9	DATA 8
10	ACK --	10	ACK
11	BUSY	11	BUSY
12	PAPER	12	PAPER
13	+ SELECT	13	+ SELECT
14	-AUTO FEED XT	14	-AUTO FEED XT
15	-ERROR	32	-ERROR
16	-INIT	31	-INIT (PRIME)
18-25	GND	15-17, 19-30	GND

apuntes

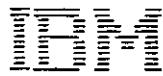

**Hardware  
Maintenance  
Service**

Part N°6139795

Revised Edition (March 1986)

The following paragraph does not apply to the United Kingdom or any country where such provisions are inconsistent with local law: INTERNATIONAL BUSINESS MACHINES CORPORATION PROVIDES THIS PUBLICATION "AS IS" WITHOUT WARRANTY OF ANY KIND, EITHER EXPRESS OR IMPLIED, INCLUDING, BUT NOT LIMITED TO, THE IMPLIED WARRANTIES OF MERCHANTABILITY OR FITNESS FOR A PARTICULAR PURPOSE. Some states do not allow disclaimer of express or implied warranties in certain transactions, therefore, this statement may not apply to you.

This publication could include technical inaccuracies or typographical errors. Changes are periodically made to the information herein; these changes will be incorporated in new editions of the publication. IBM may make improvements and/or changes in the product(s) and/or the program(s) described in this publication at any time.

It is possible that this publication may contain reference to, or information about, IBM products (machines and programs), programming, or services that are not announced in your country. Such references or information must not be construed to mean that IBM intends to announce such IBM products, programming, or services in your country.

Products are not stocked at the address below. Requests for copies of this publication and for technical information about IBM Personal Computer products should be made to your authorized IBM Personal Computer dealer, IBM Product Center, or your IBM Marketing Representative.

The following paragraph applies only to the United States and Puerto Rico: A Reader's Comment Form is provided at the back of this publication. If the form has been removed, address comments to: IBM Corporation, Personal Computer, P.O. Box 1328-C, Boca Raton, Florida 33429-1328. IBM may use or distribute any of the information you supply in any way it believes appropriate without incurring any obligations whatever.

© Copyright International Business Machines Corporation 1981, 1986

## Federal Communications Commission Radio Frequency Interference Statement

**Warning:** The equipment described herein has been certified to comply with the limits for a Class B computing device, pursuant to Subpart J of Part 15 of the FCC rules. Only peripherals (computer input/output devices, terminals printers, etc.) certified to comply with the Class B limits may be attached to the computer. Operation with non-certified peripherals is likely to result in interference to radio and TV reception. If peripherals not offered by IBM are used with the equipment, it is suggested to use shielded grounded cables with in-line filters if necessary.

### CAUTION

The products described herein are equipped with a grounded plug for the user's safety. It is to be used in conjunction with a properly grounded receptacle to avoid electrical shock.

## Safety Inspection Guide

The intent of this inspection guide is to assist you in identifying potentially unsafe conditions on these products. Each machine, as it was designed and built, had required safety items installed to protect users and service personnel from injury. This guide addresses only those items. However, good judgment should be used to identify potential safety hazards not covered by this inspection guide.

If any unsafe conditions are present, a determination must be made on how serious the apparent hazard could be and whether you can continue without first correcting the problem.

Consider these conditions and the safety hazards they present:

- Electrical hazards, especially primary power; primary voltage on the frame can cause serious or fatal electrical shock.
- Explosive hazards, a damaged CRT face or bulging capacitor can cause serious injury.

iii 0 98 A



- Mechanical hazards, loose or missing hardware can cause serious injury.

This safety inspection guide consists of a series of steps presented in a checklist. Begin the checks with the power off and the power cord removed from the electrical outlet.

We recommend all non-IBM devices and attachments be removed from the unit before you conduct the safety inspection.

Reference Literature:

- *Guide to Operations* manual.
- Any applicable safety publications.

1. Check exterior covers for damage (loose, broken, or sharp edges).
2. Power off the system. Disconnect the power cord from the electrical outlet.
3. Check the power cord for the following:
  - a. A third-wire ground connector in good condition. Use a meter to measure third-wire ground continuity for 0.1 ohm or less between the external ground pin and the frame ground.
  - b. The cord set should be the appropriate molded type as specified in the parts catalog of this manual.
  - c. Insulation must not be frayed or worn.
4. Remove the back panel from the system unit (if applicable).
5. Remove the cover mounting screws, and remove the cover.
6. Check for any obvious non-IBM alterations. Use good judgement as to the safety of any non-IBM alterations.
7. Check inside the unit for any obvious unsafe conditions, such as: metal filings, contamination, water or other liquids, or signs of fire or smoke damage.
8. Check for worn, frayed, or pinched cables. Ensure the voltage specified on the voltage tag, or switch position (back

panel of the machine) matches the voltage of the power receptacle. If in doubt, verify the voltage at the power receptacle.

9. Examine the power supply and verify the following:

- a. Nonremovable fasteners in the power-supply cover have not been removed or tampered with.
- b. The grommet is installed where the internal power cables come through the frame of the power supply.

10. Check for the following labels on all systems:

- "Caution: Hazardous Area. Do Not Remove This Cover. Trained Service People Only. No Serviceable Components Inside"

or



- Hazardous voltage inside. Do not open.

11. In systems using a battery, check for the following labels:

- "BATTERY WARNING: Do not dispose of battery unit in fire or water. See instruction for disposal in the battery installation instructions."

or



- Replace only with P/N XXXXXXX. Use of a different battery could result in ignition or explosion of battery. Order replacement from IBM authorized dealer.

12. Visually check the condition of the battery (if applicable) and ensure the battery has a safety hazard label attached.

13. Machines manufactured May 1986 or later, weighing in excess of 18 Kg. (41.8 lbs), must be labeled with the weight of the system unit.

## How to Use this Maintenance Library

This Hardware Maintenance library consists of three major diagnostic tools; a two-part set of diagnostic manuals and Advanced Diagnostics diskettes.

The *Hardware Maintenance Reference* manual describes diagnostic procedures and their use, field replaceable unit (FRU) removal and replacement procedures, and provides general information about the systems. Once the reader has become familiar with its content, the *Hardware Maintenance Reference* manual is no longer required on each service call. It can be kept in a convenient place and used as needed.

The *Hardware Maintenance Service* manual contains all necessary information to diagnose a failing system. Maintenance analysis procedures (MAPs), jumper positions, switch settings, and the parts catalog are in this manual.

Additional options may require updates to the manuals. The *Hardware Maintenance Reference* manual provides an area in the back of the manual to file the updates. Each section of the *Hardware Maintenance Service* manual (with the exception of the MAPs) has a designated update area. The MAPs are sequenced by number and can be updated accordingly.

The Advanced Diagnostics diskette is designed to be used with the MAPs to:

- Test each area of the system
- Isolate problems to specific areas of the system through the use of error codes
- Verify correct installation and operation of the system.

Other functions of the Advanced Diagnostics diskette are described in the *Hardware Maintenance Reference* manual.

## Preface

This manual provides the information needed to diagnose and repair IBM Personal Computer products. Readers should have received training on IBM Personal Computer products and be familiar with the Triplet Model 310 Multimeter<sup>1</sup> or equivalent.

The manual is divided into two major categories: system specific information and Personal Computer family diagnostic information.

The system specific information is identified by the **START** and organized as follows:

"**START**" is the entry point for all diagnostic procedures.

"**JUMPERS AND SWITCH SETTINGS**" contains jumper positions and switch settings for the system unit and supported options.

"**PARTS CATALOG**" contains illustrations and part numbers of field replaceable units (FRUs).

Step-by-step instructions to isolate failing FRUs are located in the "**DIAGNOSTIC MAPs**" section.

Related repair information can be found in the *Hardware Maintenance Reference* manual. Operating instructions are in the *Guide to Operations* manual. Detailed hardware and interface information is in the *Technical Reference* manual.

The term "Reference manual" as used in this manual, refers to the *Hardware Maintenance Reference* manual.

## START – PC, XT, and Portable PC

Place the hard-tab page labeled "START – PC, XT, and Portable PC" in place of this page, then discard this page.

## MAP 0000: Start (PC, XT, Portable PC)

This is the entry point for maintenance analysis procedures (MAPs). The MAPs will help you determine the failing field replaceable unit (FRU).

The Advanced Diagnostics program is intended to test *only* IBM products. Non-IBM products, prototype cards, and modified options can give false errors and invalid system responses.

All voltages in the MAPs are positive unless otherwise specified.

001

Before you begin:

1. Power off the system.
2. Ensure all connectors are installed correctly.
3. Ensure all jumpers and switches are set correctly.

**Note:** Ensure the Portable Personal Computer 115/230 Vac selector switch is set for the voltage available at the outlet.

- Insert the Advanced Diagnostics diskette into drive A.
- Power on the system.

### IS THE POWER SUPPLY FAN RUNNING?

Yes No

|  
|  
002

Go to Step 045 in this MAP.

003

- Listen carefully for any audio responses during the power-on self test (POST).

### DID YOU HEAR ONE SHORT BEEP AT THE END OF THE POST?

Yes No

|  
|  
(Step 004 continues)

004

Go to Step 006 in this MAP.

005

Go to Step 010 in this MAP.

006

(From Step 004 in this MAP)

**DID THE MESSAGE (RESUME = "F1" KEY) APPEAR ON THE SCREEN?**

Yes No

007

Go to Step 052 in this MAP.

008

- Make a note of any error messages on the screen.
- Press the F1 key to continue.

**DID THE MESSAGE (RESUME = "F1" KEY) GO AWAY WHEN THE F1 KEY WAS PRESSED?**

Yes No

009

Go to "MAP 0300: Keyboard Start."

010

(From Step 005 in this MAP)

**DOES THE ADVANCED DIAGNOSTICS MENU APPEAR?**

Yes No

011

Go to Step 053 in this MAP.

012

- Select 0 (SYSTEM CHECKOUT).

**Note:** Depending upon the options installed in the system, questions about attached devices may appear on the screen. Press Y or N as required, then Enter.

(Step 012 continues)

012 (continued)

**DOES THE INSTALLED DEVICES MENU APPEAR?**

Yes No

013

Go to Step 037 in this MAP.

014

- Compare the list to the options installed *inside* the system.

**Note:** The Installed Devices list displays only those devices supported by this manual. If a device is missing from the list and is not supported by this manual, press Y (IS THE INSTALLED DEVICES LIST CORRECT?) then Enter to continue the diagnostic tests. Go to Step 025 in this MAP.

**DOES THE INSTALLED DEVICES LIST CORRECTLY IDENTIFY THE DEVICES INSTALLED INSIDE THE SYSTEM?**

Yes No

015

Go to Step 017 in this MAP.

016

Go to Step 025 in this MAP.

017

(From Step 015 in this MAP)

Follow the instructions on the screen and attempt to correct the Installed Devices list.

**Note:** A 199 error indicates you answered "No" to the question about the Installed Devices list. Disregard the error.

**COULD YOU CORRECT THE INSTALLED DEVICES LIST?**

Yes No

(Step 018 continues)

018

Go to Step 020 in this MAP.

019

Go to Step 025 in this MAP.

020

(From Step 018 in this MAP)

**IS THE OPTION MISSING FROM THE INSTALLED DEVICES LIST?**

Yes No

021

Press Y (IS THE INSTALLED DEVICES LIST CORRECT?) then Enter to continue the diagnostic tests.

Go to Step 025 in this MAP.

022

- Make sure all switches and jumpers are set correctly for the missing option. Be sure to check the system board switches as well as the option's switches and jumper positions.

**ARE THE SWITCHES AND JUMPERS SET CORRECTLY?**

Yes No

023

Reset any incorrect jumper or switch settings. Go to Step 001 in this MAP to verify system operation.

024

Go to the appropriate MAP for the missing device.

**Note:** If you are unable to find the MAP that corresponds to the device, you have an IBM device with its own service manual or a device not supported by IBM diagnostic tests.

025

(From Steps 014, 016, 019, and 021 in this MAP)

- Follow the instructions on the screen to run the tests on all devices. Use the (RUN TESTS MULTIPLE TIMES) option.

**DID YOU RECEIVE AN ERROR MESSAGE?**

Yes No

026

Go to Step 028 in this MAP.

027

Go to the MAP indicated by the error code. For example, if you receive the error code 7XX, go to "MAP 0700: Math Coprocessor."

**Note:** If you are unable to find the MAP that corresponds to your error code, you have an IBM device with its own service manual or a device not supported by IBM diagnostic tests.

028

(From Step 026 in this MAP)

**DID THE SYSTEM CHECKOUT MENU APPEAR AT THE END OF TESTING?**

Yes No

029

Go to "MAP 0020: Power Start."

030

**DID YOU NOTICE ANY FAILURE SYMPTOMS?**

Yes No

031

Go to Step 033 in this MAP.

032

Go to Step 053 in this MAP.

103A

033

(From Step 031 in this MAP)

DID THE CUSTOMER PROVIDE A SYMPTOM?

Yes No

034

Go to Step 036 in this MAP.

035

Go to the MAP for the suspected failing device.

036

(From Step 034 in this MAP)

The Advanced Diagnostic tests have finished without detecting an error.

- If you are still experiencing a problem:
  - Check all switch settings.
  - Check all jumper positions.
  - Check all cables and connectors for proper installation.
  - Run the Advanced Diagnostic tests on all devices. Use the (RUN TESTS ONE TIME) option. If you receive an error, go to the MAP indicated by the error code. For example, if you receive the error code 7XX, go to "MAP 0700: Math Coprocessor."
- If you are experiencing a problem with a device not supported by this manual, refer to that device's service manual for special testing instructions.
- If you suspect an intermittent problem, start an error log. If you need instructions, refer to the Reference manual.

037

(From Step 013 in this MAP)

DID YOU RECEIVE AN ERROR MESSAGE INDICATING A DISKETTE READ ERROR?

Yes No

038

Go to Step 040 in this MAP.

039

Go to "MAP 0600: Diskette Drive Start."

040

(From Step 038 in this MAP)

IS A MATH COPROCESSOR INSTALLED IN THE SYSTEM?

Yes No

041

Go to "MAP 0300: Keyboard Start."

042

- Power off the system and remove the math coprocessor.
- Power on the system.
- Select 0 (SYSTEM CHECKOUT).

DOES THE INSTALLED DEVICES MENU APPEAR?

Yes No

043

Reinstall the math coprocessor, then go to "MAP 0300: Keyboard Start."

044

- Replace the math coprocessor and the 8088 processor. If that does not correct the problem, replace the system board.

045

(From Step 002 in this MAP)

IS THE POWER CORD PLUGGED INTO A FUNCTIONING, PROPERLY GROUNDED ELECTRICAL OUTLET?

Yes No

046

- Attach the system to a functioning, properly grounded electrical outlet. Return to Step 001 in this MAP to verify system operation.

047

- Power off the system.
- Disconnect the power cord from the electrical outlet then from the system unit.
- Check the system unit power cord for continuity.

DOES THE POWER CORD HAVE CONTINUITY?

Yes No

048

Replace the power cord.

049

- Reconnect the power cord.
- Power on the system.
- Check for a voltage of 2.4 to 5.2 Vdc between pins 1 and 5 (ground) at the system board power supply connector, Figure 1.

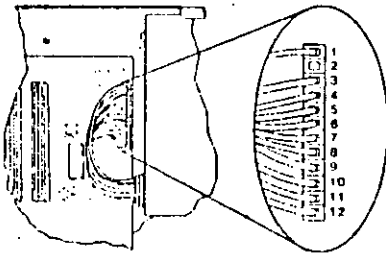

Figure 1. System Board Power Connectors

049 (continued)

IS THE VOLTAGE 2.4 TO 5.2 VDC BETWEEN PINS 1 AND 5?

Yes No

050

Go to "MAP 0020: Power Start."

051

Replace the power supply.

(From Step 007 in this MAP)

Refer to the following figure and go to the MAP indicated or take the action described.

**Note:** If you received an error message and incorrect audio response, use the error message as the POST Error Symptom.

POST Error Symptom:	Action:
No Beep and:	
Blank Display .....	MAP 0020: Power Start
Unreadable Display .....	MAP 0020: Power Start
Blinking Cursor .....	MAP 0020: Power Start
Parity Check Message .....	MAP 0200: Memory Start
1XX Error .....	MAP 0100: System Board Start
Machine Functioning Properly .....	MAP 0020: Power Start
1 Long and 1 Short Beep .....	Replace System Board
1 Long and 2 Short Beeps .....	Go to Step 054 in this MAP
1 Long and 3 Short Beeps .....	Go to Step 054 in this MAP
2 Short Beeps and:	
Blank or Unreadable Display .....	Go to Step 054 in this MAP
Distorted Image on Display .....	Go to Step 054 in this MAP
1XX Error .....	MAP 0100: System Board Start
XXXX XX 201 Error .....	MAP 0200: Memory Start
XXXX 201 Error .....	MAP 0200: Memory Start
301 Error .....	MAP 0300: Keyboard Start
XX301 Error .....	MAP 0300: Keyboard Start
601 Error .....	MAP 0600: Diskette Drive Start
17XX Error .....	MAP 1700: Fixed Disk Drive Start
30XX Error .....	MAP 3000: PC Network
31XX Error .....	MAP 3100: Alt. PC Network
C8000 ROM Error .....	Replace Fixed Disk Drive Adapter
CC000 ROM Error .....	MAP 3000: PC Network
ROM Error .....	Replace System Board
FXXXX ROM Error .....	Replace System Board
Continuous Beep .....	MAP 0020: Power Start
Repeating Short Beeps .....	MAP 0020: Power Start
Any Errors Not Shown Above .....	Go to Step 062 in this MAP

Figure 2. POST Errors

(From Steps 011 and 032 in this MAP)

Refer to the following figure and go to the MAP indicated or take the action described.

**Note:** If you received an error message and incorrect audio response, use the error message as the symptom.

Symptom:	Action:
Incorrect Memory Size Displayed .....	MAP 0200: Memory Start
Incorrect Colors on Display .....	Go to Step 054 in this MAP
No High Intensity on Display .....	Go to Step 054 in this MAP
Missing, Broken or Incorrect Characters on Display .....	Go to Step 054 in this MAP
Distorted Image on Display .....	Go to Step 054 in this MAP
Blank Display .....	Go to Step 054 in this MAP
Unreadable Display .....	Go to Step 054 in this MAP
Flashing Cursor Only .....	Go to Step 057 in this MAP
BASIC Screen Appears .....	MAP 0600: Diskette Drive Start
Loads Program from Fixed Disk .....	MAP 0600: Diskette Drive Start
Disk Boot Failure .....	MAP 0600: Diskette Drive Start
Loads Program from Remote Station .....	MAP 0600: Diskette Drive Start
PARITY CHECK Error .....	MAP 0200: Memory Start
Keyboard Problem .....	MAP 0300: Keyboard Start
Cannot Finish Diagnostic Tests .....	MAP 0020: Power Start
Printer Problems .....	Refer to the Service Manual for the Printer
Network Problems .....	Refer to the Service Manual for the Network

Figure 3. Failure Symptoms



*assembler  
comments*  
054

(From Steps 052 and 053 in this MAP)

**IS AN ENHANCED GRAPHICS ADAPTER INSTALLED?**

Yes No

|  
055

Go to the MAP for the failing display adapter.

056

Go to "MAP 2400: Enhanced Graphics Adapter."

---

057

(From Step 053 in this MAP)

**IS A MATH COPROCESSOR INSTALLED?**

Yes No

|  
058

Go to "MAP 0600: Diskette Drive Start."

059

- Power off the system.
- Remove the math coprocessor from the system board.
- Power on the system.

**DID THE FAILING SYMPTOM REMAIN?**

Yes No

|  
060

Replace the math coprocessor and the 8088 processor.

061

Reinstall the math coprocessor, then go to "MAP 0600: Diskette Drive Start."

---

107A

(From Step 052 in this MAP)

Go to the MAP indicated by the error code. For example, if you receive the error code 7XX, go to "MAP 0700: Math Coprocessor."

**Note:** If you are unable to find the MAP that corresponds to your error code, you have an IBM device with its own service manual or a device not supported by IBM diagnostic tests.

---

## Jumpers and Switch Settings

Place the hard-tab page labeled "Jumpers and Switch Settings" in place of this page, then discard this page.

# JUMPERS AND SWITCH SETTINGS

Option Compatibility .....	3
BIOS ROM Identification .....	3
Using the Switch Charts .....	4
System Board (Diskette Drives, Displays, Coprocessor, and POST Loop) .....	5
System Board (Memory) .....	6
Memory Adapter Switch Sets .....	11
Extender Card Switch Settings .....	19
Cluster Adapter .....	20
Station Address .....	20
Remote Initial Program Load .....	22
Adapter Number .....	22
Enhanced Graphics Adapter (EGA) .....	23
PC Network Adapter .....	25
Asynchronous Communications Adapter .....	26
Binary Synchronous Communications (BSC) Adapter .....	27
Data Acquisition and Control (DAC) Adapter .....	28
Analog Output Range .....	28
Analog Input Range .....	29
Adapter Number .....	29
Interrupt Request (IRQ) Level .....	30
General Purpose Interface Bus (GPIB) Adapter .....	31
Adapter Number .....	31
Interrupt Request (IRQ) Level .....	32
Interrupt Acknowledge (INT ACK) Level .....	33
Direct-Memory Access (DMA) Channel .....	33
Professional Graphics Controller .....	34
Voice Communications Adapter .....	35

## Option Compatibility

Certain option adapters conflict when used in the same system. The following adapters should not be installed together in your system unit:

- Synchronous Data Link Control (SDLC) adapter.
- Alternate Binary Synchronous Communications (Alt. BSC) adapter.

## BIOS ROM Identification

To determine the date of the BIOS ROM module, run the following BASIC program. Type the program exactly as shown.

```
10 DEF SEG=&HF000
20 FOR X=&HFFF5 TO &HFFFF
30 PRINT CHR$(PEEK(X));
40 NEXT
RUN
```

The date that is displayed is the date of your BIOS ROM module.

# Setting the Switch Charts

The following legend applies to the charts in this section.

Symbol	Meaning
.	Not Used by this Application
↑	On/Closed Position Of A Switch
↓	Off/Open Position Of A Switch
N/A	Not Allowed Or Not Applicable

**Note:** For some options, the customer must supply information for correct setting of jumpers or switches.

To set a rocker switch, press the rocker down to the desired position; to set a slide switch, slide the lug of the switch to the desired position.

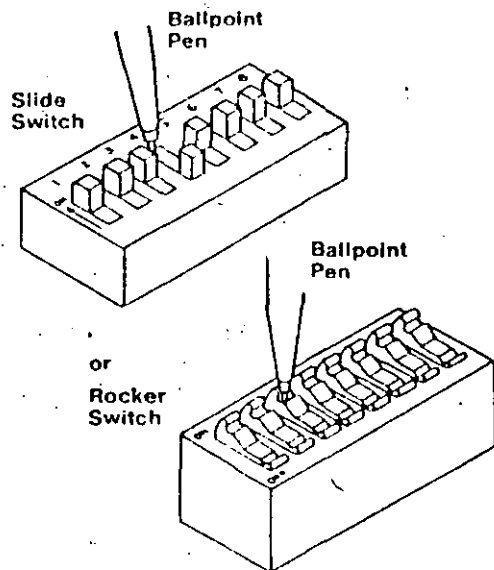

# System Board (Diskette Drives, Displays, Coprocessor, and POST Loop)

Function	System Board Switches		
	PC		PCXT & Portable
	Sw. Block 1	Sw. Block 2	Sw. Block 1
	12345678	12345678	12345678
0-Diskette Drives	↑ . . . . . ↑↑	. . . . .	N/A
1-Diskette Drive	↑ . . . . . ↑↑	. . . . .	. . . . . ↑↑
2-Diskette Drives	↑ . . . . . ↑↑	. . . . .	. . . . . ↑↑
3-Diskette Drives	N/A	N/A	. . . . . ↑↑
4-Diskette Drives	N/A	N/A	. . . . . ↓↓
No Display Adapter	. . . . . ↑↑ . . .	N/A	. . . . . ↑↑ . . .
Enhanced Graphics Adapter (Primary. See Note 1)	. . . . . ↑↑ . . .	N/A	. . . . . ↑↑ . . .
Color Graphics Adapter (40 X 25 Primary)	. . . . . ↑↑ . . .	N/A	. . . . . ↑↑ . . .
Color Graphics Adapter (80 X 25 Primary)	. . . . . ↑↑ . . .	N/A	. . . . . ↑↑ . . .
Professional Graphics Controller (Primary)	N/A	N/A	. . . . . ↑↑ . . .
Monochrome/Printer Adapter (Primary. See Note 2)	. . . . . ↑↑ . . .	N/A	. . . . . ↑↑ . . .
Math Coprocessor Installed	. ↓ . . . . .	N/A	. ↓ . . . . .
Math Coprocessor Not Installed	. ↑ . . . . .	N/A	. ↑ . . . . .
POST Loop (Allows Continuous Running)	N/A	N/A	↑ . . . . .
No POST Loop (Normal Operation)	N/A	N/A	↓ . . . . .

**Notes:**  
 1) If the Enhanced Graphics Adapter (EGA) is installed with another display adapter, set the system board switches as shown for the EGA.  
 2) The IBM Monochrome Display and Printer Adapter is not supported in the Portable Personal Computer.

# System Board (Memory)

Portable Personal Computer					
Total Memory	System Board Switch Settings	256K Card Or 64/256K Option With 256K (See Note)	64/256K Option With 192K (See Note)	64/256K Option With 128K (See Note)	64/256K Option With 64K (See Note)
	12345678	12345678	12345678	12345678	12345678
256K	**↓↑****	N/A	N/A	N/A	N/A
320K	**↓↑****	N/A	N/A	N/A	↑↑↑↑↑↓
384K	**↓↑****	N/A	N/A	↑↑↑↑↑↓	N/A
448K	**↓↑****	N/A	↑↑↑↑↑↓	N/A	N/A
512K	**↓↑****	↑↑↑↑↑↓	N/A	N/A	N/A
576K	**↓↑****	↑↑↑↑↑↓	N/A	N/A	↓↑↑↑↑↓
640K	**↓↑****	↑↑↑↑↑↓	N/A	↓↑↑↑↑↓	N/A

**Note:** The 64/256KB Memory Expansion Option and the 256KB Memory Expansion Option are the only memory options supported in the IBM Portable Personal Computer.

To use the following chart, first find the column under "System Board Type" that matches your system. Follow this column down to the switch settings for the total amount of memory in your system. Set the system board switches to match those in the chart. Then go to the "Switch Set" listed and set the switches on the memory adapters in your system. These sets of memory adapter switch settings start on page 11.

**Note:** If memory above 544K is to be installed on a 16/64KB system board, the BIOS ROM must be dated 10/27/82 or later. See "BIOS ROM Identification."

Total Memory	System Board Switch-Settings & Adapter Switch Sets	System Board Type (Note)		
		PC		PC XT
		16K-64K 12345678	64K-256K 12345678	64K-256K 12345678
16K	Switch 1	**↓↑****	N/A	N/A
	Switch 2	↑↑↑↑↑↓	N/A	N/A
	Set	N/A	N/A	N/A
32K	Switch 1	**↓↑****	N/A	N/A
	Switch 2	↑↑↑↑↑↓	N/A	N/A
	Set	N/A	N/A	N/A
48K	Switch 1	**↓↑****	N/A	N/A
	Switch 2	↑↑↑↑↑↓	N/A	N/A
	Set	N/A	N/A	N/A
64K	Switch 1	**↓↑****	**↓↑****	N/A
	Switch 2	↑↑↑↑↑↓	↑↑↑↑↑↓	N/A
	Set	N/A	N/A	N/A

**Note:** The system board's identifier is located on its left edge.

(Part 1 of 4)

1111

# Enhanced Graphics Adapter (EGA)

**Warning:** Damage to the graphics adapter, the display, or both may result if these jumpers are not in the correct position.

Total Memory	System Board Switch Settings & Adapter Switch Sets	System Board Type		
		PC		PC XT
		16K-64K 12345678	64K-256K 12345678	64K-256K 12345678
96K	Switch 1	**   ****	N/A	N/A
	Switch 2		N/A	N/A
	Set	1	N/A	N/A
128K	Switch 1	**   ****	**   ****	**   ****
	Switch 2			N/A
	Set	3	N/A	N/A
160K	Switch 1	**   ****	N/A	N/A
	Switch 2		N/A	N/A
	Set	5	N/A	N/A
192K	Switch 1	**   ****	**   ****	**   ****
	Switch 2			N/A
	Set	7	N/A	N/A
224K	Switch 1	**   ****	N/A	N/A
	Switch 2		N/A	N/A
	Set	9	N/A	N/A
256K	Switch 1	**   ****	**   ****	**   ****
	Switch 2			N/A
	Set	11	N/A	N/A
288K	Switch 1	**   ****	**   ****	**   ****
	Switch 2			N/A
	Set	13	2	2

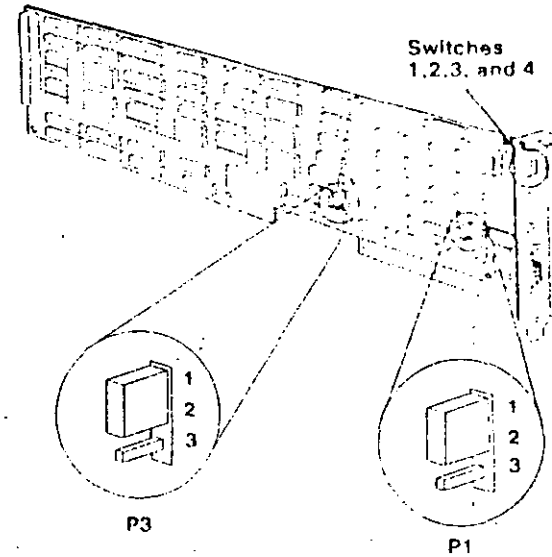

Type of Display	P1	P3
IBM Color Display or IBM Monochrome Display	2 and 3	1 and 2
IBM Enhanced Color Display	1 and 2	1 and 2

(Part 2 of 4)

If an EGA is the only display adapter installed, or an EGA and a Monochrome Display and Printer Adapter are installed in the system, refer to Figure 1 to set the EGA switches.

If an EGA is installed with a Color/Graphics Monitor Adapter, refer to Figure 2 to set the EGA Switches.

Type of Display Attached to the Enhanced Graphics Adapter	EGA as Primary	EGA as Secondary
	Switch 1234	Switch 1234
No Display	N/A	↓↓↓↓
Monochrome Display	↓↓↓↓	N/A
Color Display (40 X 25 Mode)	↑↓↓↓	↑↑↑↑
Color Display (80 X 25 Mode)	↓↓↓↓	↓↓↓↓
Enhanced Color Display (Normal Color Mode)	↑↑↑↑	↑↑↑↑
Enhanced Color Display (Enhanced Color Mode)	↑↑↑↓	↓↓↓↓

Figure 1

Type of Display Attached to the Color/Graphics Monitor Adapter	EGA as Primary	EGA as Secondary
	Switch 1234	Switch 1234
Color Display (40 X 25 Mode)	↑↑↑↓	↑↑↑↑
Color Display (80 X 25 Mode)	↓↓↓↓	↓↓↓↓
No Display (80 X 25 Mode)	↓↓↓↓	N/A

Figure 2

Notes:

1. Mode selection can be changed by programming.
2. A maximum of two displays can be attached to the system, one color display and one monochrome display.

## PC Network Adapter

Jumper Position (See figure)	Function
W1	Automatic Remote Program Load (ARPL)
W2	Not Used
W3	Sets Adapter to use Interrupt Level 2
W4	Sets Adapter to use Interrupt Level 3
W5 & W7	Sets Adapter as Alternate Adapter
W6	Sets Adapter as Primary Adapter
W8	Enables ROM on Adapter (See Note)

**Note:** Do not enable the ROM on more than one adapter.

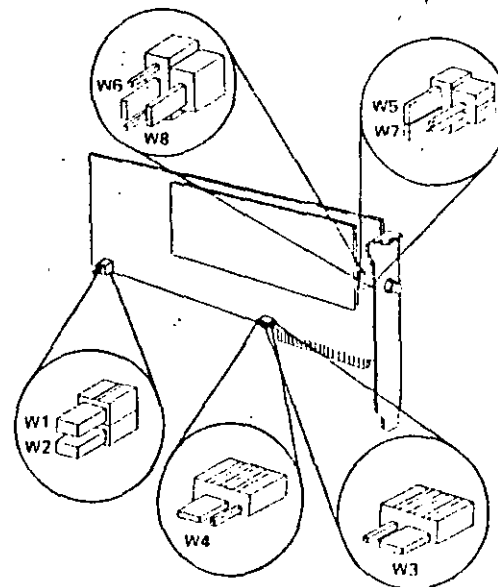

# PARTS CATALOG

## Parts Catalog

Place the hard-tab page labeled "Parts Catalog" in place of this page, then discard this page.

Limited Warranty - IBM Service Parts .....	2
How To Use This Parts Catalog .....	3
Visual Index .....	5
Assembly 1. System Unit - Exterior (5150) .....	7
Assembly 2. System Unit - Exterior (5160) .....	8
Assembly 3. System Unit - Exterior (5155) .....	9
Assembly 4. System Unit - Interior (5150) .....	10
Assembly 5. System Unit - Interior (5160) .....	12
Assembly 6. System Unit - Interior (5155) .....	14
Assembly 7. Full High Diskette Drive Type 1 .....	16
Assembly 8. Full High Diskette Drive Type 1 .....	18
Assembly 9. Full High Diskette Drive Type 2 .....	20
Assembly 10. Full High Diskette Drive Type 2 .....	22
Assembly 11. Full High Diskette Drive Type 3 .....	24
Assembly 12. Full High Diskette Drive Type 3 .....	26
Assembly 13. Diskette Drive Portable PC .....	28
Assembly 14. Fixed Disk Drive .....	29
Assembly 15. Internal Options and Adapters .....	30
Assembly 16. Expansion Unit - Exterior (5161) .....	33
Assembly 17. Expansion Unit - Interior (5161) .....	34
Assembly 18. Monochrome Display (5151) .....	36
Assembly 19. Color Display (5153) .....	38
Assembly 20. Enhanced Color Display (5154) .....	40
Assembly 21. Professional Graphics Display (5175) .....	42
Assembly 22. Keyboard (83-Key for 5150 and 5160) .....	44
Assembly 23. Keyboard (83-Key for 5155) .....	45
Assembly 24. Keybutton Kits (83-Key) .....	46
Assembly 25. Keybuttons (83-Key) .....	48
Assembly 26. Power Cords .....	50
Assembly 27. Miscellaneous .....	52



The warranty terms and conditions applicable in the country of purchase (except for the United States and Puerto Rico) in respect of an IBM Personal Computer product are available from the supplier.

## Limited Warranty - IBM Service Parts

(Applies to United States and Puerto Rico)

The International Business Machines Corporation warrants that each IBM Service Part will be free from defects in material and workmanship under conditions of normal use for a period of 90 days from the date of purchase from IBM or an Authorized IBM Personal Computer Dealer. Service Parts will be either reconditioned or new parts. Should an IBM Service Part fail to be free from defects in materials or workmanship during the 90-day warranty period, IBM will, at its option, repair or replace this Service Part at no charge in the United States or Puerto Rico. All replaced Service Parts will become the property of IBM. This limited warranty does not include service to repair damage to the Service Part resulting from accident, disaster, misuse, abuse, or non-IBM modification of the Product.

Limited Warranty service may be obtained by delivering the defective Service Part during the 90-day warranty period to an Authorized the IBM Personal Computer Dealer, or any IBM Service Exchange Center in the United States or Puerto Rico. A dated proof of purchase from IBM or an Authorized IBM Personal Computer Dealer must accompany the claim. Contact IBM by writing to IBM National Parts Center, P.O. Box 481, Greencastle, Indiana 46135 for further information.

ALL EXPRESS OR IMPLIED WARRANTIES FOR THIS SERVICE PART, INCLUDING THE WARRANTIES OF MERCHANTABILITY AND FITNESS FOR A PARTICULAR PURPOSE, ARE LIMITED IN DURATION TO A PERIOD OF 90 DAYS FROM THE DATE OF PURCHASE, AND NO WARRANTIES, WHETHER EXPRESS OR IMPLIED, WILL APPLY AFTER THIS PERIOD. SOME STATES DO NOT ALLOW LIMITATIONS ON HOW LONG AN IMPLIED WARRANTY LASTS, SO THE ABOVE LIMITATIONS MAY NOT APPLY TO YOU.

IF THIS SERVICE PART IS DEFECTIVE IN MATERIALS OR WORKMANSHIP UNDER CONDITIONS OF NORMAL USE, AS WARRANTED ABOVE, YOUR SOLE REMEDY SHALL BE REPAIR OR REPLACEMENT AS PROVIDED ABOVE. IN NO EVENT WILL IBM BE LIABLE TO YOU FOR ANY DAMAGES, INCLUDING LOST PROFITS, LOST SAVINGS OR OTHER INCIDENTAL OR CONSEQUENTIAL DAMAGES ARISING OUT OF THE USE OF OR INABILITY TO USE SUCH PRODUCT, EVEN IF IBM OR AN AUTHORIZED IBM PERSONAL COMPUTER DEALER HAS BEEN ADVISED OF THE POSSIBILITY OF SUCH DAMAGES, OR FOR ANY CLAIM BY ANY OTHER PARTY.

SOME STATES DO NOT ALLOW THE EXCLUSION OR LIMITATION OF INCIDENTAL OR CONSEQUENTIAL DAMAGES FOR CONSUMER PRODUCTS, SO THE ABOVE LIMITATIONS OR EXCLUSIONS MAY NOT APPLY TO YOU.

THIS WARRANTY GIVES YOU SPECIFIC LEGAL RIGHTS, AND YOU MAY ALSO HAVE OTHER RIGHTS WHICH MAY VARY FROM STATE TO STATE.

## How To Use This Parts Catalog

1. **Similar Parts** - If two parts are similar, they may be listed in the same list. Similar parts are referred to by one index number but are distinguished by the part number and description.
2. **NS** - When this indication appears in the ASM - INDEX column, it denotes a part not shown in the assembly. This designation is generally used for miscellaneous parts packets.
3. **R** - This entry in the Units column indicates the part has a restricted availability.
4. **AR** - As Required (AR) in the Units column denotes that the units per assembly may vary based upon system configuration.
5. **Indenture** - The indenture is marked by a series of dots located before the part description. The indenture indicates the relationships of a part to the next higher assembly.

### Example of a Parts List

ASM - INDEX	PART NUMBER	UNITS	DESCRIPTION
1 -	1234567		Main Assembly
- 1	1234568	1	• Subassembly
- 2	1234569	1	• Subassembly, US
- 2	1234566	1	• Subassembly, Non-US
- 3	1234565	R	•• Detailed Part Restricted
- 4	1234564	1	• Subassembly
			•• Detailed Part
			•• Detailed Part
			•• Detailed Part
- NS	1234563	1	• Subassembly Not Shown
			•• Detailed Part
			•• Detailed Part
- 5	1234562	AR	• Subassembly - Use as Required

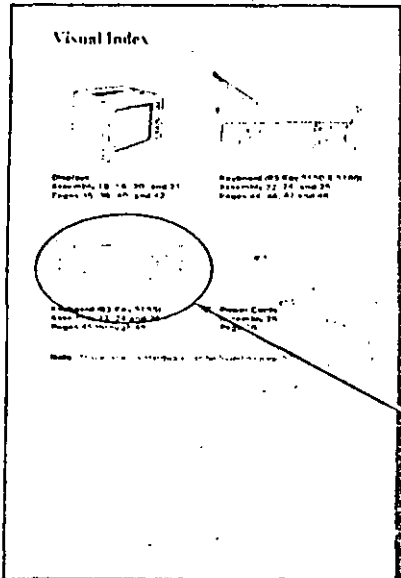

1. Turn to the visual index and locate, by illustration, the assembly containing the part.

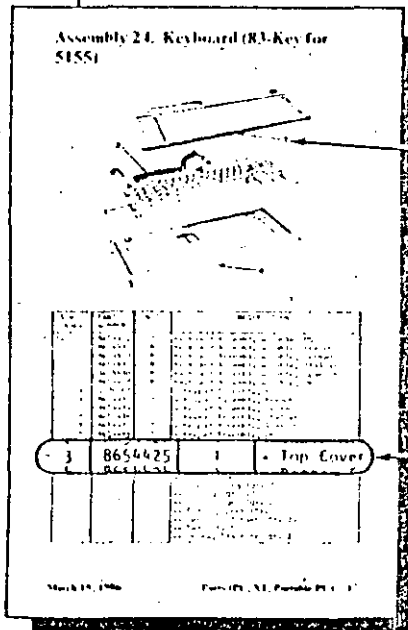

2. Turn to the page for that assembly and locate the part visually.

3. Using the index number shown with the part, refer to the accompanying listing to obtain the part number.

# Visual Index

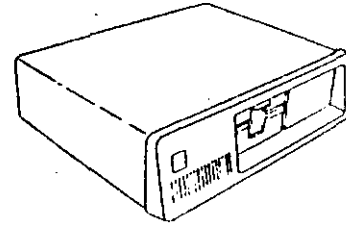

**System Unit (5150)**  
Assembly 1 and 4  
Pages 7 and 10

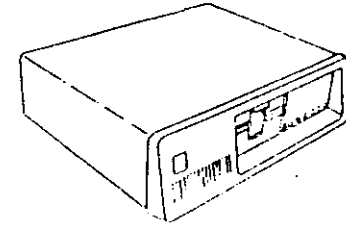

**System Unit (5160)**  
Assembly 2 and 5  
Pages 8 and 12



**System Unit (5155)**  
Assembly 3 and 6  
Pages 9 and 14



**Full-High Diskette Drives**  
Assembly 7, 8, 9, 10, 11, and 12  
Pages 16 through 26

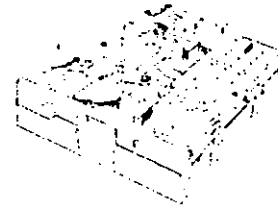

**Diskette Drive Portable PC**  
Assembly 13  
Page 28



**Fixed Disk Drive**  
Assembly 14  
Page 29

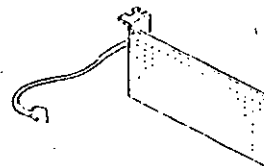

**Internal Options and Adapters**  
Assembly 15  
Page 30

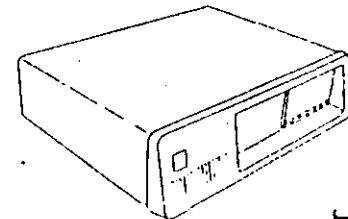

**Expansion Unit (5161)**  
Assembly 16 and 17  
Pages 33 and 34

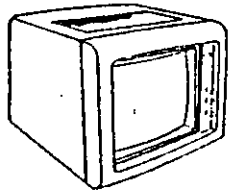

**Displays**  
 Assembly 18, 19, 20, and 21  
 Pages 36, 38, 40, and 42

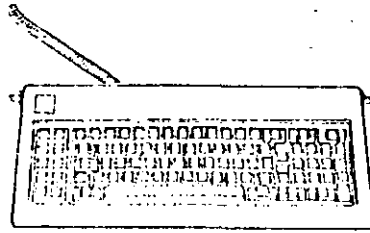

**Keyboard (83-Key 5150 & 5160)**  
 Assembly 22, 24, and 25  
 Pages 44, 46, 47 and 48

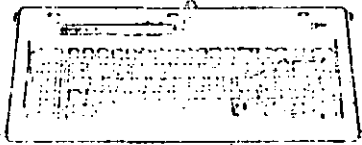

**Keyboard (83-Key 5155)**  
 Assembly 23, 24 and 25  
 Pages 45 through 48



**Power Cords**  
 Assembly 26  
 Page 50

**Note:** Miscellaneous Hardware and wrap plugs are listed on page 53.

# Assembly 3. System Unit - Exterior (5155)

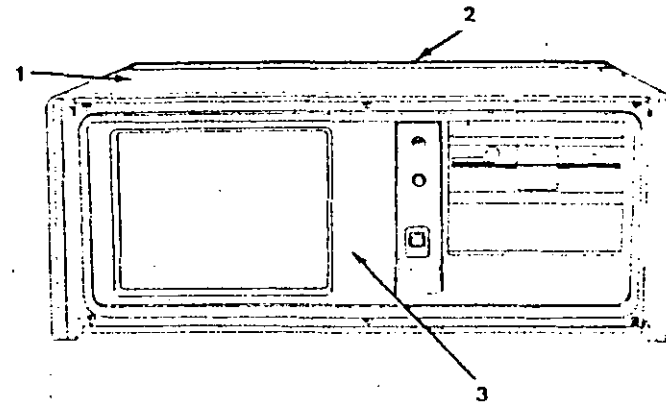

ASM - INDEX	PART NUMBER	UNITS	DESCRIPTION
3 -	8654414		Cover Assembly
- 1			• Cover
- 2			• Handle Assembly
- 3	8654413	1	• Panel Assembly
- NS	8654440	1	• Panel Assembly Kit
			•• Panel Assembly (Rear Access)
			•• Panel Retainer Kit
- NS	8654439	1	• Cover and Handle Hardware Kit
			•• Foam Pad
			•• Washer, Friction (Qty 2)
			•• Nut, Stud (Qty 2)
			•• Screw, Shoulder M4 (Qty 2)
- NS	8654445	R	• IBM Label
- NS	8654418	1	Carrying Case
- NS		1	Power Cord (See Power Cord Parts List)

# Assembly 4. System Unit - Interior (5150)

## System Unit - Interior (5150)

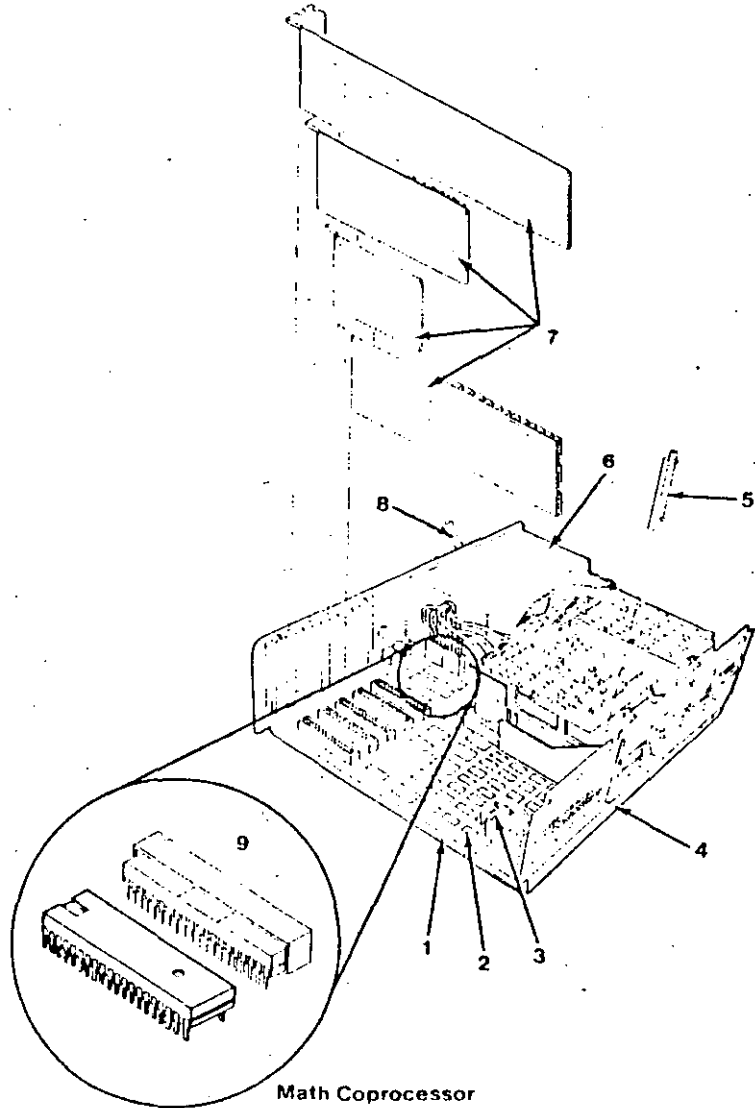

ASH - INDEX	PART NUMBER	UNITS	DESCRIPTION
6 - 1	8529254	1	System Board 64KB-256KB CPU (Populated to 128K)
- NS	8529211	AR	• 64KB Memory Module
- 2	8529143	1	Speaker and Cable
- 3	8654452	1	Cable Raceway
- 4	8654477	1	Cable, Keyboard, Internal System
- 5		1	Power Cord (See Power Cord Parts List)
- 6	8654417	1	Power Supply (Includes Fan and Information Label)
- NS	8654444	1	• Fan, Power Supply
- 7			See Internal Options and Adapters
- 8	8654415	1	Shield
- 9	8654419	1	Display Assembly
	8285975	R	• High Voltage Transformer
	8285976	R	• Yoke
- 10	8654451	1	Shield, Keyboard, Internal System
- 11	8285977	R	Brightness/Contrast Assembly
- 12	8654471	1	Diskette Ground Bracket
- NS	8654441	1	Display Assembly Hardware Kit • Knob, Brightness • Knob, Contrast
- NS	8654438	1	Front Panel Hardware Kit • Foot Assembly (Qty 2) • Panel, Bumper • Screw, Plastite (Qty 2) • Panel, Keyboard Connector • Blank Insert, Diskette Drive • Screw, attach Shroud M-4 (Qty 6) • Strip, Wear, Front Panel (Qty 2) • Screw, Controls to Panel (Qty 2)
- NS	8654442	1	System Hardware Kit • System Board Supports (Qty 6) • Screws, Skt. Head 3.5mm x 8 (Qty 16) • Bumper, Card (Qty 3) • Screw, Plastite 8-18 (Qty 6) • Mounting Screws, Diskette (Qty 4) • Attachment Card, Blank Insert • Glide, Chassis (Qty 2) • Bracket, System Board Ground • Spacer, Diskette Drive (Qty 3) • Screw, Special Bristol (Qty 7)

113

# Assembly 7. Full High Diskette Drive Type 1

## Diskette Drive - Type 1

Use only in drives that have an A, B, or nothing in front of the serial number. The serial number is visible from the top of the drive.

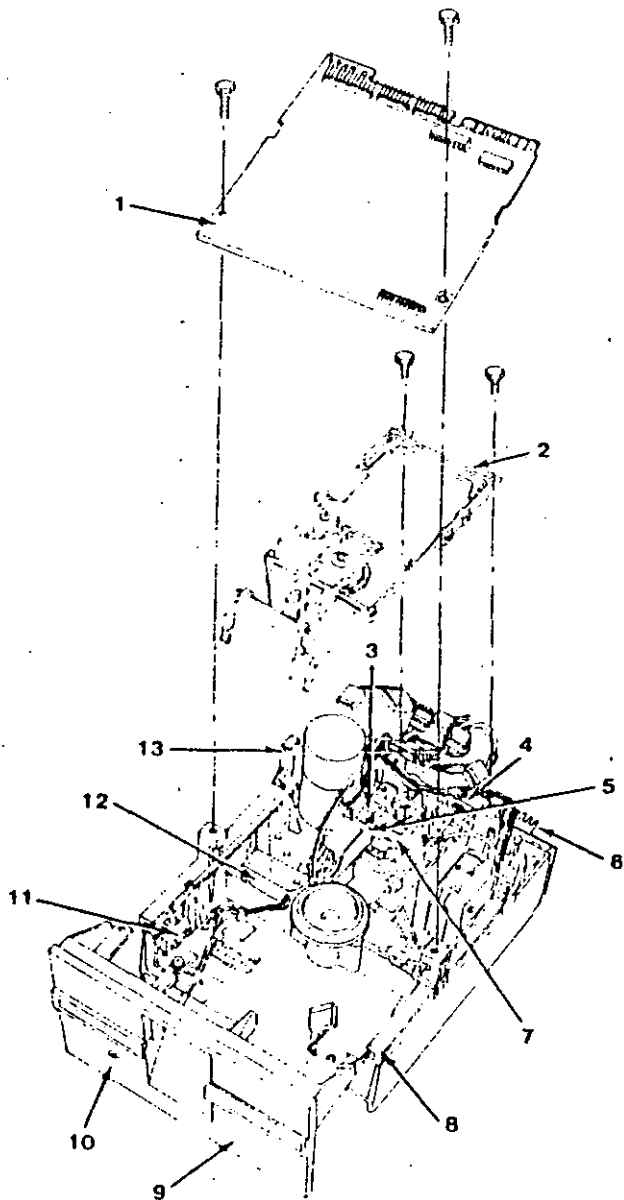

ASH - INDEX	PART NUMBER	UNITS	DESCRIPTION
7 -	8529153		Diskette Drive Assembly, Single-Sided
-	8529206		Diskette Drive Assembly, Double-Sided
- 1	8529226	1	• Logic Board with Shield
- 2	8529267	1	• Cone Lever Assembly •• Cone Lever Arm •• Cone Assembly •• Mounting Clips •• Latch Assembly
- 3	8529224	R	• Track 0 Switch
- 4	8529266	R	• Track 0 Stop
- 5	8529265	R	• SSR Upper Arm
- 6	8529256	1	• Screen Board
- 7	8529264	R	• Module SSR/150KB
- 7	8529210	R	• Module DSR/320KB
- 8	8529261	1	• Guide, Right
- 9	8529293	1	• Front Panel
- 10	8529258	1	• LED Assembly
- 11	8529225	1	• Write Protect Switch
- 12	8529257	R	• Index Assembly
- 13	8529262	1	• Guide, Left

# Assembly 8. Full High Diskette Drive Type 1

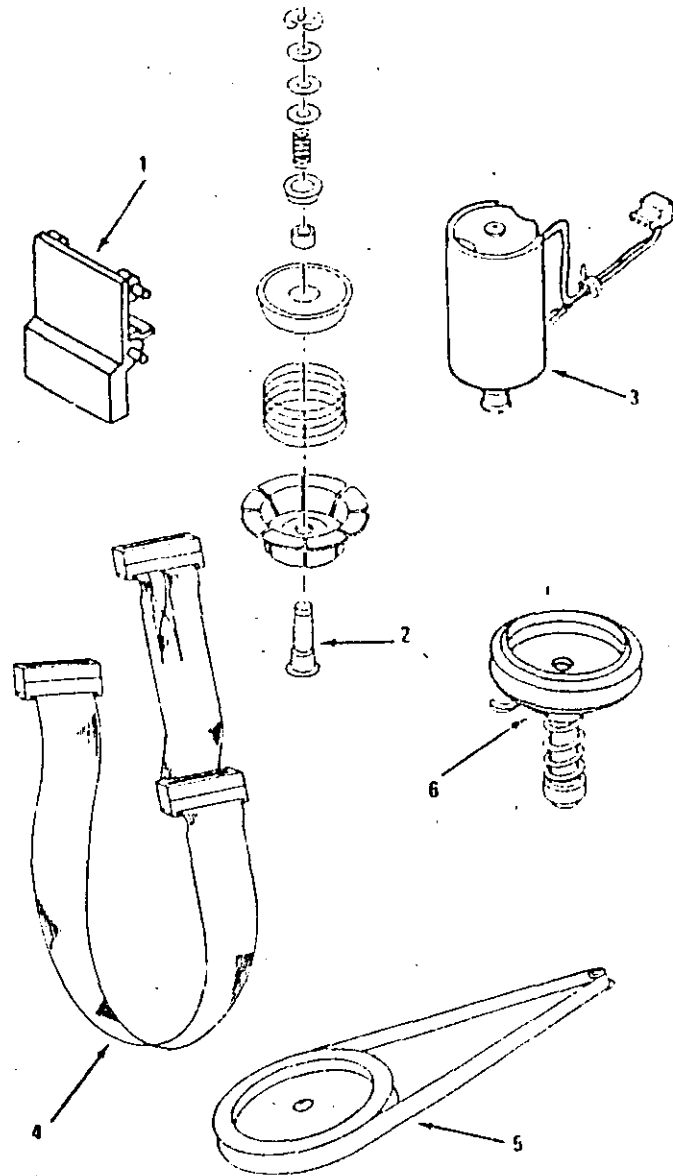

## START - AT

Place the hard-tab page labeled "START - AT" in place of this page, then discard this page.

## MAP 0000: Start (AT)

This is the entry point for all IBM PERSONAL COMPUTER AT™ MAPs. The MAPs will help you determine the failing field replaceable unit (FRU).

The Advanced Diagnostics program is intended to test *only* IBM products. Non-IBM products, prototype cards, or modified options can give false errors and invalid system responses.

All voltages in the MAPs are positive unless otherwise shown.

### 001

Before you begin:

1. Power off the system.
2. Ensure all connectors are installed correctly.
3. Ensure any jumpers or switches are set correctly.
4. Ensure the 115/230 Vac selector switch is set for the voltage available at the outlet.
5. Verify the options are correctly set by running the Setup program. After running the Setup program (or if you cannot run the Setup program) continue with Step 001.

- Insert the Advanced Diagnostics diskette into drive A.
- Power on the system.

### IS THE POWER SUPPLY FAN RUNNING?

Yes No

|

002

Go to Step 058 in this MAP.

### 003

- Listen carefully for any audio responses during the power-on self test (POST).

### DID YOU HEAR ONE SHORT BEEP AT THE END OF THE POST?

Yes No

|

(Step 004 continues)

004

Go to Step 006 in this MAP.

005

Go to Step 034 in this MAP.

006

(From Step 004 in this MAP)

**DID YOU RECEIVE A 16X ERROR?**

Yes No

007

Go to Step 011 in this MAP.

008

**DID YOU RECEIVE A 161 ERROR?**

Yes No

009

Go to Step 016 in this MAP.

010

Go to "MAP 0100: System Board Start."

011

(From Step 007 in this MAP)

**DID THE MESSAGE (RESUME = "F1" KEY) APPEAR ON THE SCREEN?**

Yes No

012

Go to Step 073 in this MAP.

013

- Make a note of any error messages on the screen.
- Press the F1 key to continue.

**DID THE MESSAGE (RESUME = "F1" KEY) GO AWAY WHEN THE F1 KEY WAS PRESSED?**

Yes No

(Step 014 continues)

073

(From Step 012 in this MAP)

Find your error in the following figure and take the action indicated.

**Note:** If an error message and incorrect audio response occur, take the action indicated for the error message.

POST Error:	Action:
No Beep and:	
Blank Display.....	MAP 0020 Power Start
Blinking Cursor.....	MAP 0020 Power Start
Unreadable Display.....	MAP 0020 Power Start
Machine Functioning Properly.....	MAP 0020 Power Start
1XX Error.....	MAP 0100 System Board Start
1 Long and 1 Short Beep.....	Replace System Board
1 Long and 2 Short Beeps.....	Go to Step 075 in this MAP
1 Long and 3 Short Beeps.....	Go to Step 075 in this MAP
2 Short Beeps and:	
Blank or Unreadable Display.....	Go to Step 075 in this MAP
Distorted Display Image.....	Go to Step 075 in this MAP
1XX Error.....	MAP 0100 System Board Start
XXXXXX XXXX 201 Error.....	MAP 0300 Memory Start
30X Error.....	MAP 0300 Keyboard Start
XX30X Error.....	MAP 0300 Keyboard Start
601 Error.....	MAP 0600 Diskette Drive Start
17XX Error.....	MAP 1700 Fixed Disk Drive Start
30XX Error.....	MAP 3000 PC Network
31XX Error.....	MAP 3100 All PC Network
C0000 ROM Error.....	Replace Fixed Disk Drive Adapter
IO ROM CC0000.....	MAP 3000 PC Network
ROM Error.....	Replace System Board
IO ROM XXXXXX (IO Adapter Failure).....	MAP 0020 Power Start
Continuous Beep.....	MAP 0020 Power Start
Repeating Short Beeps.....	MAP 0020 Power Start
Any Errors Not Shown Above.....	Go to Step 083 in this MAP

Figure 2. POST Errors

122



**074**

(From Steps 032, 035, and 056 in this MAP)

Find your error in the following figure and take the action indicated.

Symptom:	Action:
Incorrect Memory Size Displayed During the POST.....	MAP 0200: Memory Start
<b>Display Problems:</b>	
Incorrect Colors .....	Go to Step 075 in this MAP
No High Intensity .....	Go to Step 075 in this MAP
Missing, Broken, or Incorrect Characters.....	Go to Step 075 in this MAP
Blank Display (Dark) .....	Go to Step 075 in this MAP
Blank Display (Bright).....	Go to Step 075 in this MAP
Distorted Image .....	Go to Step 075 in this MAP
Unreadable Display.....	Go to Step 075 in this MAP
Other Display Problems .....	Go to Step 075 in this MAP
Flashing Cursor Only.....	Go to Step 078 in this MAP
BASIC Screen Appears .....	MAP 0600: Diskette Drive Start
Loads Program from Fixed Disk.....	MAP 0600: Diskette Drive Start
Loads Program from Remote Station.....	MAP 0600: Diskette Drive Start
Diskette Boot Failure .....	MAP 0600: Diskette Drive Start
PARITY CHECK.....	MAP 0200: Memory Start
Keyboard Problem.....	MAP 0300: Keyboard Start
Cannot Finish Diagnostic Tests .....	MAP 0020: Power Start
Printer Problems.....	Refer to the Service Manual for the Printer.
Network Problems.....	Refer to the Service Manual for the Network.

Figure 3. Failure Symptoms

**075**

(From Steps 073 and 074 in this MAP)

**IS AN ENHANCED GRAPHICS ADAPTER INSTALLED?**

Yes No

**076**

Refer to the MAP for the failing display adapter.

**077**

Go to "MAP 2400: Enhanced Graphics Adapter."

**078**

(From Step 074 in this MAP)

**IS A MATH COPROCESSOR INSTALLED?**

Yes No

**079**

Go to "MAP 0600: Diskette Drive Start."

**080**

- Power off the system.
- Remove the math coprocessor from the system board.
- Power on the system.

**DID THE FAILING SYMPTOM REMAIN?**

Yes No

**081**

Replace the math coprocessor.

**082**

Reinstall the math coprocessor, then go to "MAP 0600: Diskette Drive Start."

**08**  
(From Step 073 in this MAP)  
Go to the MAP indicated by the error code. For example, if you receive the error code 7XX, go to "MAP 0700: Math Coprocessor."

**Note:** If you are unable to find the MAP that corresponds to your error code, you have an IBM device with its own service manual or a device not supported by IBM diagnostic tests.

**Jumpers and Switch Settings**

Place the hard-tab page labeled "Jumpers and Switch Settings" in place of this page, then discard this page.

# JUMPERS AND SWITCH SETTINGS

System Setup .....	3
Option Compatibility .....	5
BIOS ROM Identification .....	5
Terminating Resistors and Switches .....	6
Diskette Drive .....	6
Fixed Disk Drive .....	7
Power Supply Voltage Selector Switch .....	8
Using the Switch Charts .....	9
System-Board Display Switch .....	10
Memory Expansion Options .....	11
Base Memory .....	11
Expansion Memory .....	11
Cluster Adapter .....	12
Station Address .....	12
Remote Initial Program Load .....	14
Adapter Number .....	14
Enhanced Graphics Adapter (EGA) .....	15
PC Network Adapter .....	17
Serial/Parallel Adapter .....	18
Binary Synchronous Communications (BSC) Adapter .....	19
Data Acquisition and Control (DAC) Adapter .....	20
Analog Output Range .....	20
Analog Input Range .....	21
Adapter Number .....	21
Interrupt Request (IRQ) Level .....	22
General Purpose Interface Bus (GPIB) Adapter .....	23
Adapter Number .....	23
Interrupt Request (IRQ) Level .....	24
Interrupt Acknowledge (INT ACK) Level .....	25
Direct-Memory Access (DMA) Channel .....	25
Professional Graphics Controller .....	26
Voice Communications Adapter .....	27

# System Setup

The Setup program is on the Advanced Diagnostics diskette. You need to know what options are installed in the system unit to run the Setup program.

1. Make a list of the option adapters installed in the system.
2. Determine the type of drives installed.
  - Fixed Disk Drive: An identification label is on the front of the drive.
  - Diskette Drive: The bezel of a double-sided (360K) diskette drive has an asterisk; the bezel of a high-capacity (1.2M) diskette drive is not marked.
3. Ensure that all jumpers and switches are set correctly.

**Note:** If you receive an error code, troubleshoot any error indications other than 16X first. If the only error code you receive is 16X, and you cannot correct the Setup program using the instructions on the following page, go to "MAP 0000: Start (AT)."

## System Setup

1. Insert the Advanced Diagnostics diskette into diskette drive A.
2. Power on the system.
3. When the Advanced Diagnostics menu appears, select option 4 (SETUP) and verify that the options are correctly set.

The Setup program will prompt you for the following information:

<b>Time</b>	Set or change the time.
<b>Date</b>	Set or change the date.
<b>Diskette Drives</b>	Select the number and type (high capacity or double sided) installed.
<b>Fixed Disk Drives</b>	Select the number and type of drives installed.
<b>Memory</b>	Select the amount of base and expansion memory installed.
<b>Display</b>	Set the primary display if two display adapters are installed. Select the mode (40 or 80 column) if a color display is installed.

## Option Compatibility

Certain option adapters conflict with each other when used in the same system. The following adapters should not be installed together in the system unit:

- Synchronous Data Link Control (SDLC) Adapter
- Alternate Binary Synchronous Communications (Alt BSC) Adapter.

## BIOS ROM Identification

To determine the date of the BIOS ROM module, run the following BASIC program. Type the program exactly as shown.

```
10 DEF SEG=&HF000
20 FOR X=&HFFF5 TO &HFFFF
30 PRINT CHR$(PEEK(X));
40 NEXT
RUN
```

The date that is displayed is the date of your BIOS ROM module.

# Terminating Resistors and Switches

## Diskette Drive

A diskette drive may have a terminating resistor or terminating switch.

- **Terminating Resistor** - A terminating resistor must be installed in diskette drive A. Diskette drive B should not have a terminating resistor installed.
- **Terminating Switch** - If a diskette drive is equipped with a terminating switch instead of the terminating resistor, set all switches on diskette drive A to the On position. Set all switches on diskette drive B to the Off position.

**Note:** The terminating resistor may appear in a different location on the drive. If so, an identifying label will be attached to the terminating resistor.

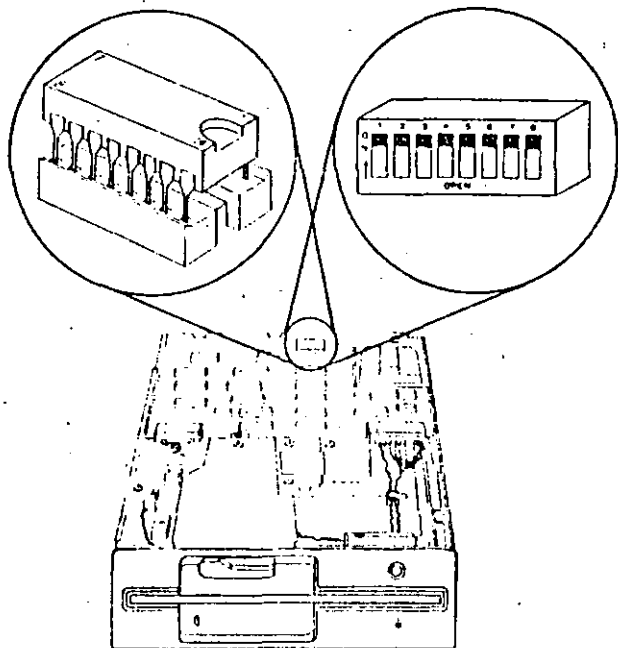

## Fixed Disk Drive

- The terminating resistor must be installed on fixed disk drive C.
- In a system unit with two fixed disk drives, remove the terminating resistor from fixed disk drive D.

**Note:** The terminating resistor may appear in a different location on the drive. If so, an identifying label will be attached to the terminating resistor.

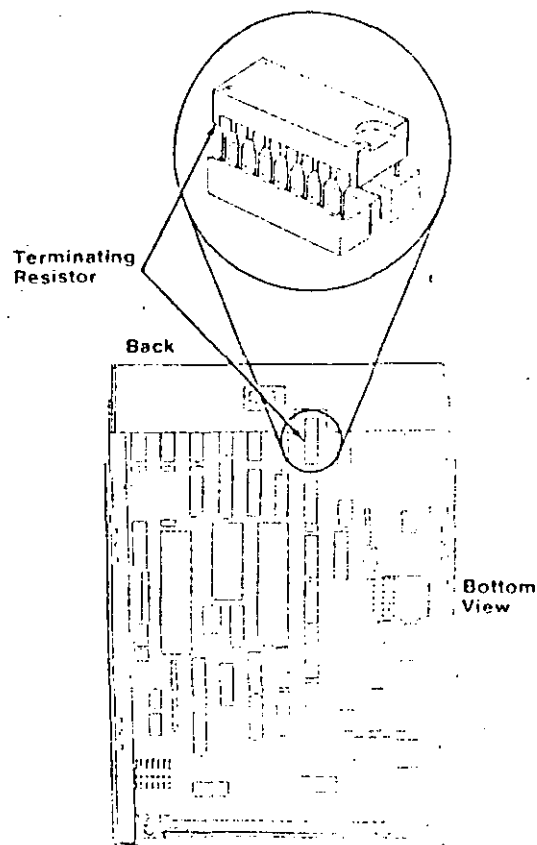

# Power Supply Voltage Selector Switch

The voltage selector switch is located at the rear of the system unit power supply. It must be set for the voltage present at the electrical outlet.

Switch Position	Voltage Range
115 Vac	100 to 125 Vac
230 Vac	200 to 240 Vac

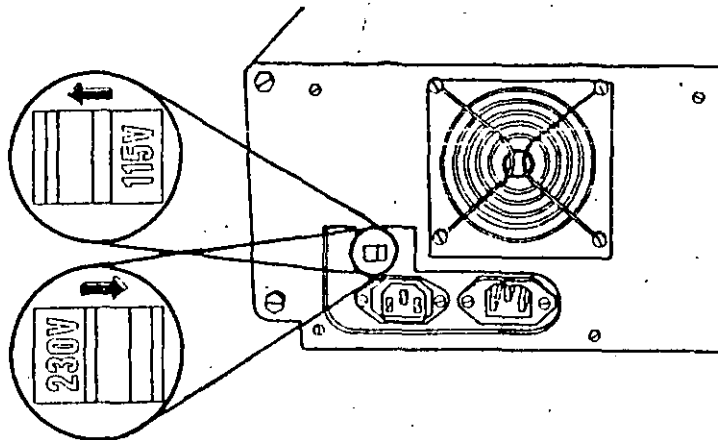

# Using the Switch Charts

The following legend applies to the charts in this section.

Symbol	Meaning
-	Not Used by this Application
↑	On/Closed Position of a Switch
↓	Off/Open Position of a Switch
N/A	Not Allowed Or Not Applicable

**Note:** For some options, the customer must supply information for correct setting of jumpers or switches.

To set a rocker switch, press the rocker down to the desired position; to set a slide switch, slide the lug of the switch to the desired position.

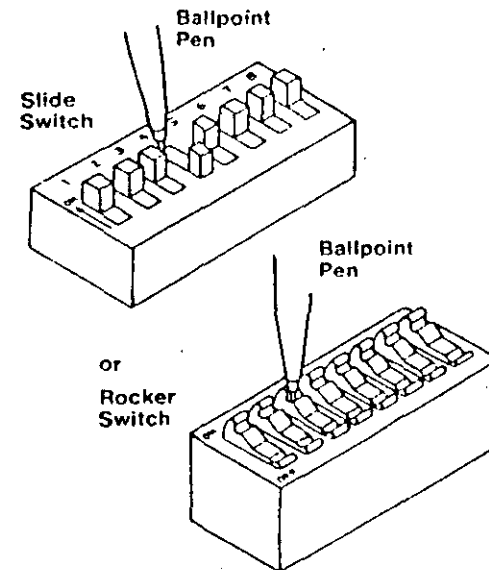

# System-Board Display Switch

If your primary display adapter is a:

- Monochrome Display and Printer Adapter - Set the display switch to the rear of the system.
- Color display adapter - Set the display switch to the front of the system.

Monochrome Display

Color Display

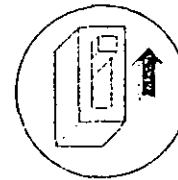

Primary Display Switch

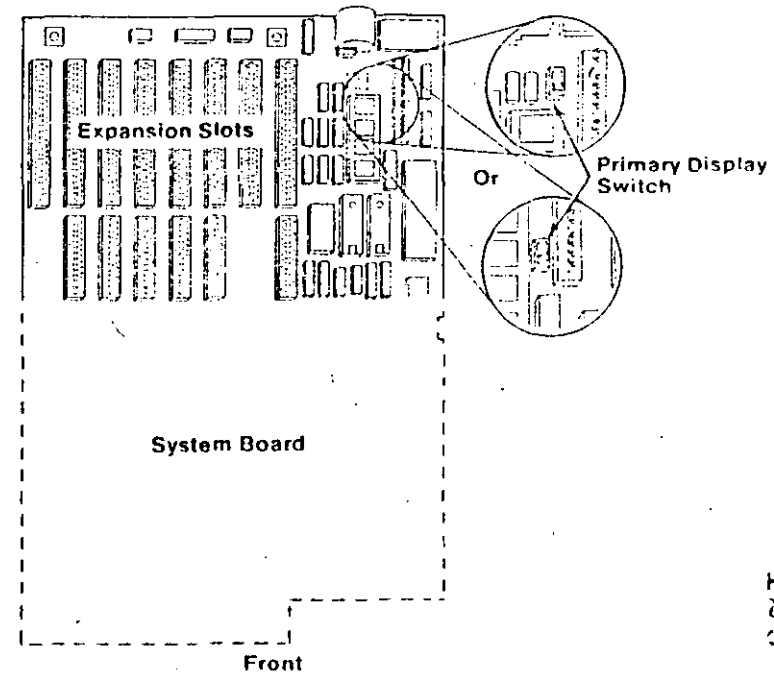
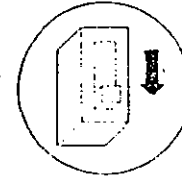

# DIAGNOSTIC MAPs

## DIAGNOSTIC MAPs

Place the hard-tab page labeled "DIAGNOSTIC MAPs" in place of this page, then discard this page.

MAP 0020: Power Start .....	0020-1
MAP 0020: Power (PC) .....	0020-1
MAP 0020: Power (AT) .....	0020-1
MAP 0100: System Board Start .....	0100-1
MAP 0100: System Board (PC) .....	0100-1
MAP 0100: System Board (AT) .....	0100-1
MAP 0200: Memory Start .....	0200-1
MAP 0200: Memory (PC) .....	0200-1
MAP 0200: Memory (XT) .....	0200-1
MAP 0200: PC Family Expansion Memory .....	0200-1
MAP 0200: Memory (AT) .....	0200-1
MAP 0300: Keyboard Start .....	0300-1
MAP 0300: Keyboard (PC) .....	0300-1
MAP 0300: Keyboard (AT) .....	0300-1
MAP 0400: Monochrome Display and Printer Adapter .....	0400-1
MAP 0500: Color/Graphics Monitor Adapter ..	0500-1
MAP 0600: Diskette Drive Start .....	0600-1
MAP 0600: Full-High Diskette Drive .....	0600-1
MAP 0600: Diskette Drive (Portable PC) .....	0600-1
MAP 0600: Diskette Drive (AT) .....	0600-1
MAP 0700: Math Coprocessor .....	0700-1
MAP 0900: Parallel Port Start .....	0900-1
MAP 0900: Printer Adapter .....	0900-1
MAP 0900: Serial/Parallel Adapter - Parallel Port .....	0900-1
MAP 1000: Alternate Serial/Parallel Adapter - Parallel Port .....	1000-1
MAP 1100: Serial Port Start .....	1100-1
MAP 1100: Asynchronous Communications Adapter .....	1100-1
MAP 1100: Serial/Parallel Adapter - Serial Port ..	1100-1
MAP 1200: Alternate Serial Port Start .....	1200-1
MAP 1200: Alternate Asynchronous Communications Adapter .....	1200-1
MAP 1200: Alternate Serial/Parallel Adapter - Serial Port .....	1200-1
MAP 1300: Game Control Adapter .....	1300-1





# MAP 0020: Power Start

Symptom Explanation	Conditions That Could Cause This Symptom
You have entered this MAP because you were unable to complete the POST, you have been directed here from another MAP, or you suspect a power problem.	<ul style="list-style-type: none"> <li>• The power supply is failing.</li> <li>• A diskette drive is failing.</li> <li>• A fixed disk drive is failing.</li> <li>• An option adapter is failing.</li> <li>• The system board is failing.</li> <li>• The math coprocessor is failing.</li> <li>• The speaker is failing.</li> </ul>

**001**  
Find your system type in the following figure and go to the MAP indicated.

System Type	MAP
Personal Computer .....	MAP 0020: Power (PC)
Personal Computer XT .....	MAP 0020: Power (PC)
Portable PC .....	MAP 0020: Power (PC)
Personal Computer AT .....	MAP 0020: Power (AT)

Figure 1. System Identification

# MAP 0020: Power (PC)

Symptom Explanation	Conditions That Could Cause This Symptom
You have entered this MAP because you were unable to complete the POST, you have been directed here from another MAP, or you suspect a power problem.	<ul style="list-style-type: none"> <li>• The power supply is failing.</li> <li>• A diskette drive is failing.</li> <li>• A fixed disk drive is failing.</li> <li>• An option adapter is failing.</li> <li>• The system board is failing.</li> <li>• The math coprocessor is failing.</li> <li>• The speaker is failing.</li> </ul>

- 001**
- Power off the system.
  - Unplug the power cord of the system unit (and expansion unit, if attached) from the electrical outlet.
  - Disconnect the keyboard and any external devices, except the primary display (and expansion unit if attached) from the system unit.
  - Plug the power cord of the system unit (and expansion unit, if attached) into the electrical outlet.
  - Power on the system.

**Note:** A 301 error may occur if you disconnected the keyboard. Disregard this error.

**DID THE SYMPTOM REMAIN?**

Yes No

**002**  
**CAUTION**

Power off the system before connecting any device.

- Connect the external devices to the system unit, one at a time.  
(Step 002 continues)

**002 (continued)**

- Power on the system after connecting each device.. Repair or replace the device that causes the failure to return.

**003**

- Power off the system.
- Connect the keyboard to the system unit.
- Disconnect the expansion unit cable (if attached) from the system unit.
- Power on the system unit; do not power on the expansion unit.

**Note:** An 1801 error code may appear if you disconnected an expansion unit. Disregard the error and continue with the POST.

**DID THE SYMPTOM REMAIN?**

Yes No

**004**

Go to Step 039 in this MAP.

**005**

- Check for a voltage of 2.4 to 5.2 Vdc between pins 1 and 5 (ground) at the system board power connector (Figure 1).

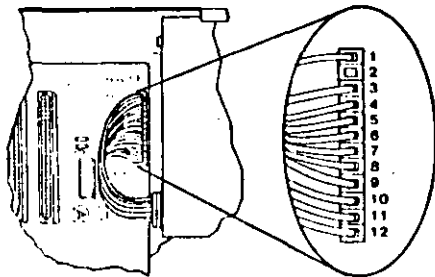

Figure 1. System Board Power Connector

**005 (continued)**

**DO YOU HAVE 2.4 TO 5.2 VDC BETWEEN PINS 1 AND 5?**

Yes No

**006**

Go to Step 012 in this MAP.

**007**

- Check the system board power connectors for the correct voltages (Figure 2).

Voltage (Vdc)		Pins	
Minimum	Maximum	-Lead	+Lead
+ 4.8	+ 5.2	5	10
+ 4.5	+ 5.4	9	6
+11.5	+12.6	7	3
+10.8	+12.9	4	8

Figure 2. System Board Voltages

- Check the diskette drive and fixed disk drive power connectors for the correct voltages (Figure 3).

Voltage (Vdc)		Pins	
Minimum	Maximum	-Lead	+Lead
+ 4.8	+ 5.2	2	4
+11.5	+12.6	3	1

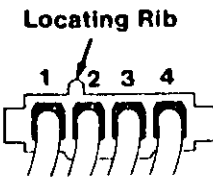

Figure 3. Diskette and Fixed Disk Drive Power Connectors

**ARE ALL VOLTAGES CORRECT?**

Yes No

**008**

(Step 008 continues)

008 (continued)  
Replace power supply.

009

- Power off the system.
- Disconnect the speaker cable from the system board.
- Check the continuity of the speaker.

**DOES THE SPEAKER HAVE CONTINUITY?**

Yes No

010

Replace the speaker.

011

Reconnect the speaker then go to Step 016 in this MAP.

---

012

(From Step 006 in this MAP)

You may have a failing diskette drive or fixed disk drive. Perform the following procedure.

- Power off the system.
- Remove the power supply connector from one of the drives.
- Power on the system.

**DID THE SYMPTOM REMAIN?**

Yes No

013

Replace the failing drive.

014

- Repeat this procedure for any remaining drives.

**DID THE SYMPTOM REMAIN?**

Yes No

015

Replace the failing drive.

(Step 016 continues)

016

(From Step 011 in this MAP)

**IS A MATH COPROCESSOR INSTALLED IN THE SYSTEM UNIT?**

Yes No

017

Go to Step 021 in this MAP.

018

- Power off the system.
- Remove the math coprocessor from the system board.
- Power on the system.

**DID THE SYMPTOM REMAIN?**

Yes No

019

Replace the math coprocessor and the 8088 processor.

020

Reinstall the math coprocessor then continue with Step 021 in this MAP.

---

021

(From Steps 017 and 020 in this MAP)

An adapter may be failing. Perform the following procedure:

- Power off the system.
- Remove one option adapter from the system board. Do not remove the diskette drive adapter or the primary display adapter.
- Power on the system.
- Repeat the above procedure until you find the failing adapter, or all option adapters, except the diskette drive adapter and the primary display adapter, have been removed.

**Note:** As adapters are removed, switches may need to be reset to match the system configuration.

(Step 021 continues)

021 (continued)

**DID THE SYMPTOM REMAIN?**

Yes No

022

Replace the last adapter removed.

023

- Power off the system.
- Remove the diskette drive adapter from the system board.
- Power on the system.

**Note:** Removal of the diskette drive adapter may result in a 601 error code. Disregard the error and continue with the POST.

**DID THE SYMPTOM REMAIN?**

Yes No

024

Replace the diskette drive adapter.

025

**IS THE PRIMARY DISPLAY ADAPTER AN ENHANCED GRAPHICS ADAPTER?**

Yes No

026

Go to Step 030 in this MAP.

027

- Power off the system.
- Remove the Enhanced Graphics Adapter from the system board.
- Set switches 5 and 6 of Switch Block 1 on the system board for color display operation. Set switch 5 to the Off position and 6 to the On position.
- Power on the system.

(Step 027 continues)

027 (continued)

**DID YOU RECEIVE ONE LONG AND TWO SHORT BEEPS?**

Yes No

028

Go to Step 033 in this MAP.

029

Replace the Enhanced Graphics Adapter. Set the system board switches back to their original settings.

---

030

(From Step 026 in this MAP)

- Power off the system.
- Remove the primary display adapter from the system board.
- Power on the system.

**DID YOU RECEIVE ONE LONG AND TWO SHORT BEEPS?**

Yes No

031

Go to Step 033 in this MAP.

032

- Replace the primary display adapter.
- 

033

(From Steps 028 and 031 in this MAP)

- Check for a voltage of 2.4 to 5.2 Vdc between pins 1 and 5 (ground) at the system board power connector (Figure 4 on page 0020-8).

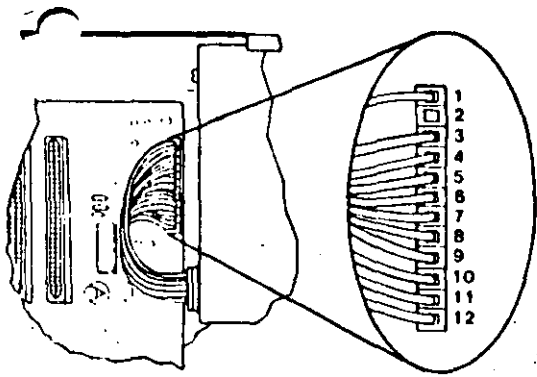

Figure 4. System Board Power Connectors

**DO YOU HAVE 2.4 TO 5.2 VDC BETWEEN PINS 1 AND 5?**

Yes No

034

Go to Step 036 in this MAP.

035

Replace the system board.

---

036

(From Step 034 in this MAP)

- Power off the system.
- Disconnect the power supply connectors from the system board.
- Ensure all option adapters have been removed from the system board.
- Check for resistance as shown in Figure 5 on page 0020-9.

Pins		Minimum Resistance
-Lead	+Lead	
5	3	17 Ohms
6	4	17 Ohms
7	9	17 Ohms
8	10	0.8 Ohms
8	11	0.8 Ohms
8	12	0.8 Ohms

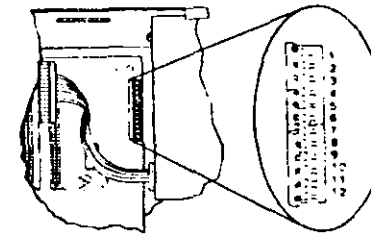

Figure 5. System Board Resistance

**ARE ANY RESISTANCE VALUES BELOW THE MINIMUM INDICATED?**

Yes No

037

Replace the power supply.

038

Replace the system board.

---

039

(From Step 004 in this MAP)

- Power off the system.
- Connect the expansion unit cable.
- Insert the Advanced Diagnostics diskette into drive A.
- Power on the system.

**Note:** An 1801 error may occur. Disregard the error and continue with the POST.

(Step 039 continues)



046

You have successfully completed the Advanced Diagnostic tests. If you suspect an intermittent problem, start an error log. If you need instructions, refer to the Reference manual.

047

Replace the expansion card.

## MAP 0020: Power (AT)

Symptom Explanation	Conditions That Could Cause This Symptom
You have entered this MAP because you were unable to complete the POST, you have been directed here from another MAP, or you suspect a power problem.	<ul style="list-style-type: none"> <li>• The power supply is failing.</li> <li>• The diskette drive is failing.</li> <li>• The fixed disk drive is failing.</li> <li>• An option adapter is failing.</li> <li>• The system board is failing.</li> <li>• The math coprocessor is failing.</li> <li>• The speaker is failing.</li> </ul>

001

**ARE YOU IN THIS MAP FOR A 101 OR 107 POST ERROR MESSAGE?**

Yes No

002

Go to Step 004 in this MAP.

003

Go to Step 017 in this MAP.

004

(From Step 002 in this MAP)

- Power off the system.
- Unplug the system unit power cord from the electrical outlet.
- Verify the 115/230 Vac selector switch is set for the correct voltage.
- Disconnect all cables and external devices, except the display, from the system unit.
- Plug the system unit power cord into the electrical outlet.
- Power on the system.

(Step 004 continues)



004 (continued)  
**DID THE SYMPTOM REMAIN?**

Yes No

005

**CAUTION**

Power off the system before connecting any device.

- Connect the external devices to the system unit, one at a time, until the symptom returns.
- Repair or replace the device causing the failure.

006

- Power off the system.
- Remove the system unit cover.
- Reseat the power connectors.
- Power on the system.
- Check for a voltage of 2.4 to 5.2 Vdc between pins 1 and 5 (ground) at power supply connector P8.

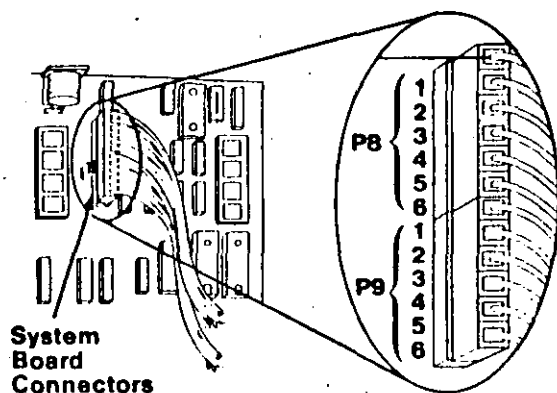

Figure 1. System Board Power Supply Connector

**DO YOU HAVE 2.4 TO 5.2 VDC BETWEEN PINS 1 AND 5?**

Yes No

(Step 007 continues)

007

Go to Step 013 in this MAP.

008

- Check the system board power connectors for the correct voltages (see Figure 2).
- Check the diskette drive and fixed disk drive power connectors for the correct voltages ( see Figure 3).

**Note:** If no fixed disk drives are installed in the system, a power supply load resistor is required for normal operation of the power supply. It may be attached to either connector P10 or P11.

Voltage (Vdc)		Pins	
Minimum	Maximum	-Lead	+Lead
+ 4.8	+ 5.2	P8-5	P9-4
+ 4.5	+ 5.4	P9-3	P8-6
+11.5	+12.6	P9-1	P8-3
+10.8	+12.9	P8-4	P9-2

Figure 2. System Board Voltages

Voltage (Vdc)		Pins	
Minimum	Maximum	-Lead	+Lead
+ 4.8	+ 5.2	2	4
+11.5	+12.6	3	1

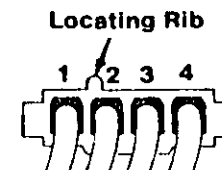

Figure 3. Diskette Drive and Fixed Disk Drive Voltages

**ARE ALL VOLTAGES CORRECT?**

Yes No

009

Replace the power supply.

(Step.010 continues)

010

- Power off the system.
- Set the meter to the Ohms X 1 scale.
- Disconnect the speaker cable from the system board.
- Check the continuity of the speaker.

**DOES THE SPEAKER HAVE CONTINUITY?**

Yes No

011

Replace the speaker.

012

- Reconnect the speaker.
- Go to Step 013 in this MAP.

013

(From Steps 007, 012, and 015 in this MAP)

You may have a failing diskette drive or fixed disk drive. Perform the following:

- Power off the system.
- Remove the power connector from one of the drives.
- Power on the system.

**DID THE SYMPTOM REMAIN?**

Yes No

014

Replace the failing drive.

015

- Reinstall the connector you removed in Step 013 in this MAP.
- Perform the same procedure for any remaining drives.

**DID THE SYMPTOM REMAIN?**

Yes No

016

Replace the failing drive.

(Step 017 continues)

017

(From Step 003 in this MAP)

You may have a failing adapter. Perform the following:

- Power off the system.
- Remove one option adapter from the system board. Do not remove the Fixed Disk and Diskette Drive Adapter or the primary display adapter.
- Power on the system.
- Repeat this procedure until you find the failing adapter or all option adapters (except the Fixed Disk and Diskette Drive Adapter and primary display adapter) have been removed.

**DID THE SYMPTOM REMAIN?**

Yes No

018

Replace the last adapter removed.

019

You may have a failing math coprocessor.

**IS A MATH COPROCESSOR INSTALLED IN THE SYSTEM?**

Yes No

020

Go to Step 023 in this MAP.

021

- Power off the system.
- Remove the math coprocessor from the system board.
- Power on the system.

**DID THE SYMPTOM REMAIN?**

Yes No

022

Replace the math coprocessor. If this does not correct the problem, replace the system board.

023

(From Step 020 in this MAP)

(Step 023 continues)

**023 (continued)**

- Power off the system.
- Remove the Fixed Disk and Diskette Drive Adapter from the system board.
- Power on the system.

Removal of the Fixed Disk and Diskette Drive Adapter results in a 601 error code, disregard this error.

**DID THE SYMPTOM REMAIN?**

Yes No

**024**

Replace the Fixed Disk and Diskette Drive Adapter. If that does not correct the problem, replace the system board.

**025**

- Power off the system.
- Remove the primary display adapter from the system board.
- Power on the system.

Removal of the primary display adapter results in one long and two short beeps during the POST.

**DID YOU RECEIVE ONE LONG AND TWO SHORT BEEPS?**

Yes No

**026**

Go to Step 028 in this MAP.

**027**

Replace the primary display adapter. If that does not correct the problem replace the system board.

**028**

(From Step 026 in this MAP)

- Power off the system.
- Wait 10 seconds.
- Power on the system.
- Check for a voltage of 2.4 to 5.2 Vdc between pins 1 and 5 (ground) at power supply connector P8.

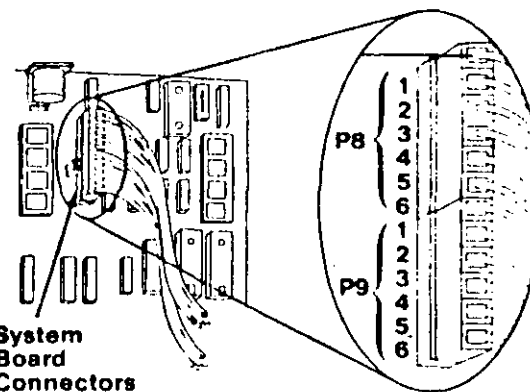

Figure 4. System Board Power Supply Connector

**DO YOU HAVE 2.4 TO 5.2 VDC BETWEEN PINS 1 AND 5?**

Yes No

**029**

Replace the power supply. If that does not correct the problem, replace the system board.

**030**

Replace the system board. If that does not correct the problem replace the power supply.

# IAP 0100: System Board Start

Symptom Explanation	Conditions That Could Cause This Symptom
You have entered this MAP because you were unable to complete the POST, or you received a 1XX error message.	<ul style="list-style-type: none"> <li>The system board is failing.</li> </ul>

001

Find your system type in the following figure and go to the MAP indicated.

System Type	MAP
Personal Computer.....	MAP 0100: System Board (PC)
Personal Computer XT.....	MAP 0100: System Board (PC)
Portable PC.....	MAP 0100: System Board (PC)
Personal Computer AT.....	MAP 0100: System Board (AT)

Figure 1. System Identification

# MAP 0100: System Board (PC)

Symptom Explanation	Conditions That Could Cause This Symptom
You have entered this MAP because you were unable to complete the POST, or you received a 1XX error message.	<ul style="list-style-type: none"> <li>The system board is failing.</li> </ul>

001

- Power off the system.
- Insert the Advanced Diagnostics diskette into drive A.
- Power on the system.

## DID THE POST FINISH WITHOUT A 1XX ERROR MESSAGE?

Yes No

002

Replace the system board.

003

- Select 0 (SYSTEM CHECKOUT).
- Run the System Board tests. Use the (RUN TESTS MULTIPLE TIMES) option.

## DID YOU RECEIVE A 1XX ERROR MESSAGE?

Yes No

004

You have successfully completed the Advanced Diagnostic tests. If you suspect an intermittent problem, start an error log. If you need instructions, refer to the Reference manual.

(Step 005 continues)

005

**DID YOU RECEIVE A 199 ERROR MESSAGE?**

Yes No

006

Replace the system board.

007

- Refer to "MAP 0000: Start (PC)," and verify the installed devices.

**Note:** The 199 error message indicates you answered "No" to the question about the installed devices list.

**MAP 0100: System Board (AT)**

Symptom Explanation	Conditions That Could Cause This Symptom
You have entered this MAP because you were unable to complete the POST, or you received a IXX error message.	<ul style="list-style-type: none"> <li>The system board is failing.</li> <li>The battery is failing.</li> <li>The keyboard cable is failing.</li> <li>The keyboard is failing.</li> </ul>

001

- Power off the system.
- Insert the Advanced Diagnostics diskette into drive A.
- Wait at least 10 seconds.
- Power on the system.

**DID YOU RECEIVE A IXX ERROR MESSAGE DURING THE POST?**

Yes No

002

Go to Step 004 in this MAP.

003

Go to Step 009 in this MAP.

004

(From Step 002 in this MAP)

**DID THE ADVANCED DIAGNOSTICS MENU APPEAR ON THE SCREEN?**

Yes No

005

Go to "MAP 0000: Start (AT)."

006

(Step 006 continues)

143

- continued)
- Press 0 (SYSTEM CHECKOUT).
- Run the System Board tests. Use the (RUN TESTS MULTIPLE TIMES) option.

**DID YOU RECEIVE A IXX ERROR?**

Yes No

007

You have successfully completed the Advanced Diagnostic tests. If you suspect an intermittent problem, start an error log. If you need instructions, refer to the Reference manual.

008

Replace the system board.

009

(From Step 003 in this MAP)

Find your error code in the following figure and take the action indicated.

Error Code	Action
105	Go to Step 018 in this MAP.
162, 163, 164	Go to MAP 0000: Start.
101, 107	Go to MAP 0020: Power.
151, 161	Go to Step 010 in this MAP.
102, 103, 104, 106, 108, 109, 121, 152	Replace the System Board.

Figure 1. POST Errors

010

(From Step 009 in this MAP)

This error message indicates a new or a defective battery is in the system.

(Step 010 continues)

0100-2 System Board (AT)

010 (continued)

IS A NEW BATTERY INSTALLED IN THE SYSTEM?

Yes No

011

Go to Step 015 in this MAP.

012

Run the Setup program and correct any errors.

**Note:** A 161 Battery Defective or New Battery Installed message appears during the POST after battery installation or replacement.

**DID RUNNING THE SETUP PROGRAM CORRECT THE PROBLEM?**

Yes No

013

Go to Step 015 in this MAP.

014

You have successfully completed the Advanced Diagnostic tests. If you suspect an intermittent problem, start an error log. If you need instructions, refer to the Reference manual.

015

(From Steps 011 and 013 in this MAP)

Disconnect the battery from the system board and check the voltage between pins 1 and 4 on the battery cable connector.

**WAS THE VOLTAGE AT LEAST 6.0 VDC?**

Yes No

016

Replace the battery.

**CAUTION**

Fire, explosion, and severe burn hazard can be caused by the battery. DO NOT recharge, disassemble, heat above 100°C (212°F), solder directly to the cell, incinerate, or expose battery cell contents to water.

(Step 017 continues)

017

- Replace the system board.
- 

018

(From Step 009 in this MAP)

- Power off the system.
- Disconnect the keyboard cable from the system unit.
- Power on the system.

**DID YOU RECEIVE A 105 ERROR MESSAGE?**

Yes No

019

Go to Step 021 in this MAP.

020

- Replace the system board.
- 

021

(From Step 019 in this MAP)

- Power off the system.
- Disconnect the keyboard cable from the keyboard.
- Refer to Figure 2 on page 0100-5, and check the keyboard cable for continuity.

**Note:** Check the continuity of wires 1, 2, 4, and 5 (wire 3 is not used).

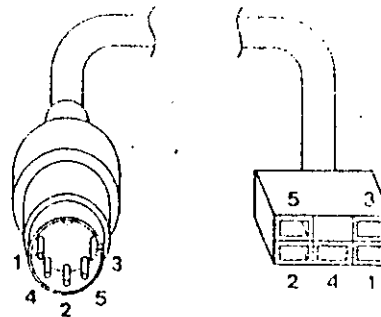

Figure 2. Continuity Check

**DOES THE KEYBOARD CABLE HAVE CONTINUITY?**

Yes No

022

Replace the keyboard cable.

023

Replace the keyboard assembly.

---

# MAP 0200: Memory Start

Symptom Explanation	Conditions That Could Cause This Symptom
You have entered this MAP because you were unable to complete the POST, the memory size displayed was incorrect, there was a memory parity check, you received an error message indicating a memory failure, or you have been directed here from another MAP.	<ul style="list-style-type: none"> <li>• A memory module is failing.</li> <li>• A memory-expansion adapter is failing.</li> <li>• The system board is failing.</li> <li>• The Setup program options are not correctly set.</li> </ul>

**001**  
Find your system and system board type in the following figure and go to the MAP indicated.

System Type	System Board	MAP
Personal Computer .....	16/64KB .....	MAP 0200: Memory PC
Personal Computer .....	64/256KB .....	MAP 0200: Memory PC
Portable PC .....	64/256KB .....	MAP 0200: Memory XT
Personal Computer XT .....	64/256KB .....	MAP 0200: Memory XT
Personal Computer AT .....	All .....	MAP 0200: Memory AT
<b>Note:</b> 16/64KB and 64/256KB system boards are marked along the left edge of the system board.		

Figure 1. System Identification

# MAP 0200: Memory (PC)

**001**  
When a memory failure is detected during the POST, a 201 error message preceded by a four-character error code (XXXX 201) may be displayed. This error message lasts about 1 second before being replaced by a Parity Check message. Watch the display carefully and make a note of the four-character error code.

- Power off the system.
- Insert the Advanced Diagnostics diskette into drive A.
- Power on the system.

## DID A 201 ERROR OCCUR DURING THE POST?

Yes No

|  
002

Go to Step 004 in this MAP.

**003**

Go to Step 011 in this MAP.

**004**

(From Step 002 in this MAP)

## IS THE ADVANCED DIAGNOSTICS MENU DISPLAYED?

Yes No

|  
005

Go to "MAP 0020: Power Start."

**006**

- Select 0 (SYSTEM CHECKOUT).

## DOES THE AMOUNT OF MEMORY DISPLAYED ON THE INSTALLED DEVICES MENU MATCH THE AMOUNT OF INSTALLED MEMORY?

Yes No

|  
007

(Step 007 continues)



007 (continued)  
Go to Step 018 in this MAP.

008

- (From Step 020 in this MAP)
- Press Y (IS THE LIST CORRECT).
  - Press 0 (RUN TESTS ONE TIME).
  - Press 2 (XXX KB MEMORY).

**DID YOU RECEIVE AN ERROR MESSAGE DURING DIAGNOSTIC TESTS?**

Yes No

009

You have successfully completed the Advanced Diagnostic tests. If you suspect an intermittent problem, start an error log. If you need instructions, refer to the Reference manual.

010

- Note the four-character error code as shown in Figure 1. You will need it for later steps.

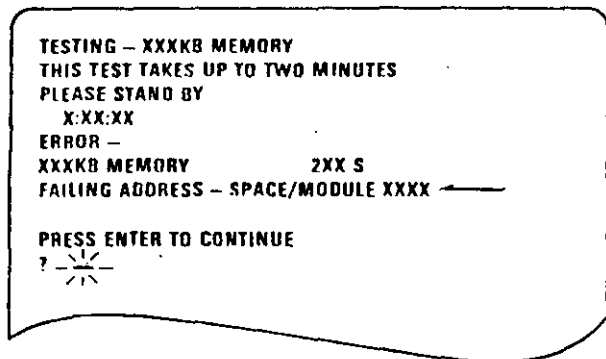

Figure 1. Advanced Diagnostics Error Message

Continue with Step 011 in this MAP.

011

(From Steps 003 and 010 in this MAP)  
**IS A 16/64KB SYSTEM BOARD INSTALLED?**

Yes No

012

Go to Step 021 in this MAP.

013

**IS THE FIRST CHARACTER OF THE ERROR CODE 0?**

Yes No

014

Go to "MAP 0200: PC Family Expansion Memory."

015

- Find the failing bank and module in Figure 2.

Notes:

1. The failing bank is identified by the first two characters of the error code.
2. The failing module is identified by the last two characters of the error code.

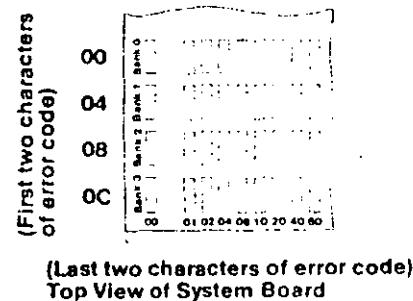

Figure 2. System Board

(Step 015 continues)

015 (continued)

**DID YOU FIND THE FAILING MODULE?**

Yes No

016

Replace the nine modules in the failing bank. If this does not correct the problem, replace the system board.

017

Replace the failing module, then go to Step 001 to verify system operation.

---

018

(From Step 007 in this MAP)

- Check the memory switches on the system board and any installed memory expansion options.

**ARE THE SWITCH SETTINGS CORRECT?**

Yes No

019

Correct the switch settings, then go to Step 001 to verify system operation.

020

- Press N then Enter.
  - Follow the instructions on the screen to correct the memory size, then go to Step 008 in this MAP to verify system operation.
- 

021

(From Step 012 in this MAP)

**IS THE FIRST CHARACTER OF THE ERROR CODE 0, 1, 2, OR 3?**

Yes No

022

Go to "MAP 0200: PC Family Expansion Memory."

023

(Step 023 continues)

023 (continued)

- Find the failing bank and module in Figure 3.

Notes:

1. The failing bank is identified by the first character of the error code.
2. The failing module is identified by the last two characters of the error code.

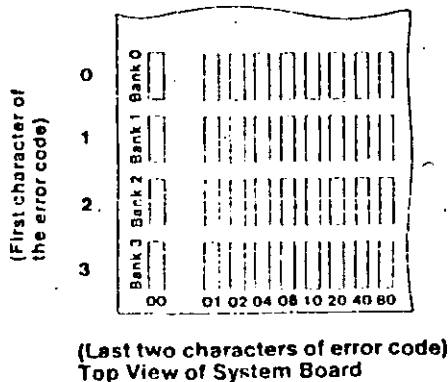

Figure 3. System Board

DID YOU FIND THE FAILING MODULE?

Yes No

024

Replace the nine modules in the failing bank. If this does not correct the problem, replace the system board.

025

Replace the failing module, then go to Step 001 to verify system operation.

MAP 0200: Memory (XT)

001

- Power off the system.
- Insert the Advanced Diagnostics diskette into drive A.
- Power on the system.

DID A 201 ERROR OCCUR DURING THE POST?

Yes No

002

Go to Step 004 in this MAP.

003

Go to Step 017 in this MAP.

004

(From Step 002 in this MAP)

DID THE ADVANCED DIAGNOSTICS MENU APPEAR?

Yes No

005

Go to Step 025 in this MAP.

006

- Select 0 (SYSTEM CHECKOUT).

DOES THE AMOUNT OF MEMORY DISPLAYED ON THE INSTALLED DEVICES LIST MATCH THE AMOUNT OF MEMORY INSTALLED?

Yes No

007

Go to Step 022 in this MAP.

008

(From Step 024 in this MAP)

IS THE INSTALLED DEVICES LIST CORRECT?

Yes No

(Step 009 continues)

19

Press N and follow the instructions on the screen, then go to Step 010 in this MAP.

010

(From Step 009 in this MAP)

- Press Y (IS THE LIST CORRECT).
- Press 0 (RUN TESTS ONE TIME).
- Press 2 (XXX KB MEMORY).

**DID YOU RECEIVE AN ERROR MESSAGE DURING DIAGNOSTIC TESTS?**

Yes No

011

You have successfully completed the Advanced Diagnostic tests. If you suspect an intermittent problem, start an error log. If you need instructions, refer to the Reference manual.

012

**DOES THE ERROR MESSAGE HAVE A 201 ERROR CODE DISPLAYED?**

Yes No

013

Go to Step 025 in this MAP.

014

- Note the seven-character error code (XXXXXX XX) as shown in Figure 1 on page 0200-3.

TESTING - XXXKB MEMORY  
 THIS TEST TAKES UP TO TWO MINUTES  
 PLEASE STAND BY  
 X:XX:XX  
 ERROR - XXXKB MEMORY 201S  
 FAILING ADDRESS - SPACE/MODULE XXXXX XX ←

PRESS ENTER TO CONTINUE



Figure 1. Advanced Diagnostic Error Message

**IS THE FIRST CHARACTER OF THE SEVEN-CHARACTER ERROR CODE 0, 1, 2, OR 3?**

Yes No

015

Go to "MAP 0200: PC-Family Expansion Memory."

016

Go to Step 019 in this MAP.

017

(From Step 003 in this MAP)

201 is preceded by a seven-character error code (XXXXXX XX 201).

**IS THE FIRST CHARACTER OF THE SEVEN-CHARACTER ERROR CODE 0, 1, 2, OR 3?**

Yes No

018

Go to "MAP 0200: PC Family Expansion Memory."

019

(From Step 016 in this MAP)

- Find the failing bank and module in Figure 2 on page 0200-4.

**Notes:**

1. The failing bank is identified by the first character of the error code.
2. The failing module is identified by the last two characters of the error code.

First Character of the Error Code
0 = Bank 0
1 = Bank 1
2 = Bank 2
3 = Bank 3

Last Two Characters of the Error Code
00 = P
01 = 0
02 = 1
04 = 2
08 = 3
10 = 4
20 = 5
40 = 6
80 = 7

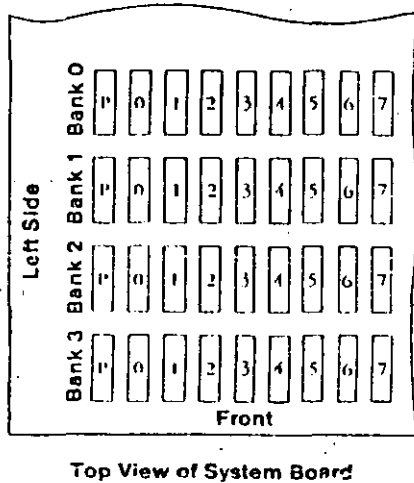

Figure 2. System Board

**DID YOU FIND THE FAILING MEMORY MODULE?**

Yes No

020

Replace the nine modules in the failing bank. If this does not correct the problem, replace the system board.

021

Replace the failing module, then go to Step 001 in this MAP to verify system operation.

022

(From Step 007 in this MAP)

- Check the memory switch settings on the system board and any installed memory expansion options.

**ARE THE SWITCH SETTINGS CORRECT?**

Yes No

023

Correct the switch settings, then go to Step 001 to verify system operation.

024

- Press **N** then **Enter**.
- Follow the instructions on the screen to correct the memory size, then go to Step 008 in this MAP.

025

(From Steps 005 and 013 in this MAP)

**IS A PARITY CHECK MESSAGE DISPLAYED?**

Yes No

026

Go to "MAP 0020: Power Start."

027

**IS A FIVE-CHARACTER ERROR CODE DISPLAYED UNDER THE PARITY CHECK MESSAGE?**

Yes No

028

Go to "MAP 0020: Power Start."

029

**IS THE FIRST CHARACTER OF THE ERROR CODE 0, 1, 2, OR 3.**

Yes No

030

Go to "MAP 0200: PC Family Expansion Memory."

(Step 031 continues)

05.

- Find the failing bank in the following figure.

Note: The failing bank is identified by the first character of the error code.

- Replace the nine memory modules in the failing bank, then go to Step 001 to verify system operation.

First Character of the Error Code
0 = Bank 0
1 = Bank 1
2 = Bank 2
3 = Bank 3

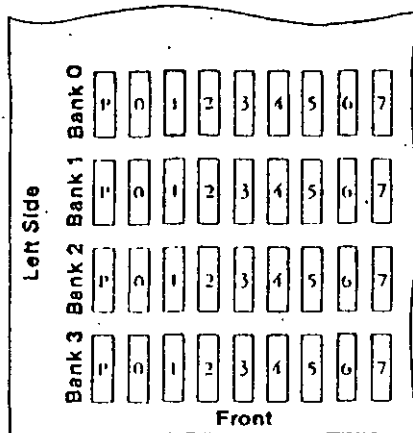

Top View of System Board

Figure 3. System Board

## TEST POINT REFERENCE PAGE

for

## TYPE 1 DISKETTE DRIVES

(Drives with a serial number prefix A, B, or no prefix)

## Preliminary Speed Check

1. Remove the diskette drive.
2. Plug the power connector into the diskette drive logic board. Leave the signal cable disconnected.
3. Insert a scratch diskette into the diskette drive.
4. Connect a jumper between TP-10 and TP-13 of the diskette drive logic board.
5. Power on the system.
6. Observe the strobe marks on the drive pulley under fluorescent lighting.

**Note:** The outer ring is for 60 hertz and the inner ring is for 50 hertz.

If the speed is correct, the appropriate ring of strobe marks will appear to stand still.

## Preliminary Speed Adjustment

Adjust the variable resistor on the servo board until the appropriate ring of strobe marks appears to stand still.

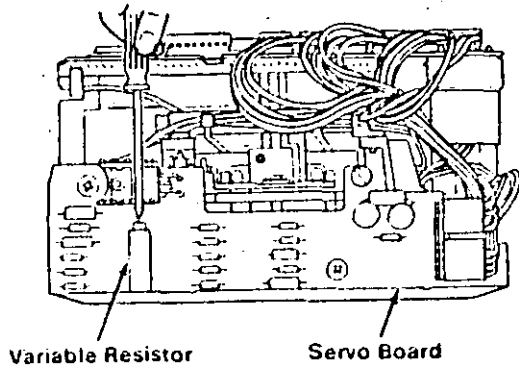

## Final Speed Adjustment

1. Power off the system.
2. Insert the Advanced Diagnostic into the diskette drive.
3. Power on the system.
4. Run the Diskette Drive and Adapter tests. Use the (RUN TESTS MULTIPLE TIMES) option.
5. When the Diskette Diagnostic menu appears, select option 4, (SPEED TEST).
6. Adjust the variable resistor on the servo board until the speed falls within the range displayed.

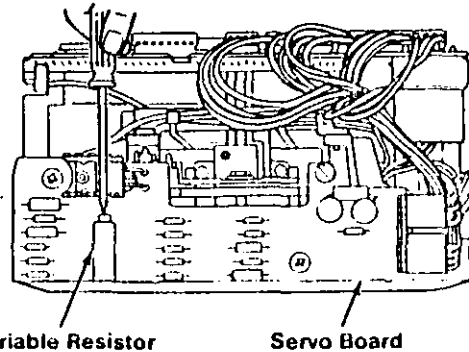

## Test Point Reference Chart

Test Point	Location	Specifications
A	J2-20	Increases from 0 Vdc to 5.0 Vdc while inserting a diskette in the drive.
B	U6 Pin 5	Decreases from 5.0 Vdc to 0 Vdc while inserting a diskette in the drive.
C	J3-16 (+)	1.5 Vdc minimum across these two test points.
D	J3-15 (-)	
E	J3-24	0 Vdc before the LED lights.
F	U6 Pin 1	As the LED initially lights, the voltage increases by 0.2 Vdc
G	J3-3	3 Vdc to 12 Vdc with the LED on.
H	J3-14	Decreases from 5.0 Vdc to 0 Vdc while inserting a diskette into the drive.

Requested Voltage Reading	Minimum	Maximum
Approximately 0 Vdc	0.0 Vdc	0.8 Vdc
Approximately 0.2 Vdc	0.15 Vdc	0.25 Vdc
Approximately 0.5 Vdc	0.5 Vdc	1.0 Vdc
Approximately 5.0 Vdc	2.0 Vdc	5.5 Vdc
Approximately 12 Vdc	11.2 Vdc	12.6 Vdc

## Test Point Locations

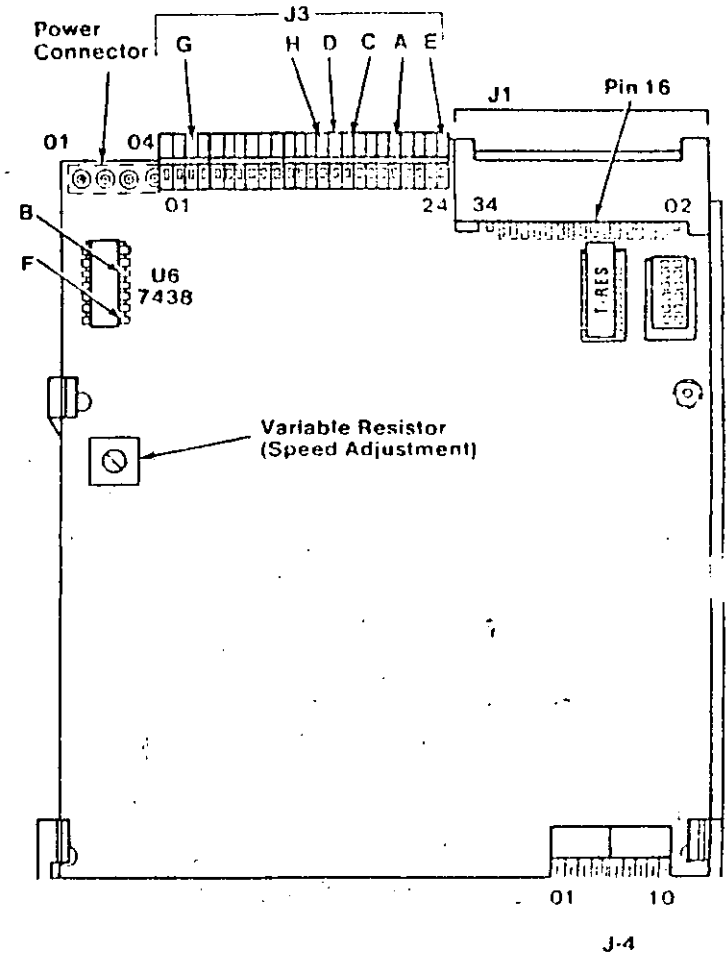

ICE PAGE

DRIVES

prefix D)



## Preliminary Speed Check:

1. Remove the diskette drive.
2. Plug the power connector into the diskette drive logic board. Leave the signal cable disconnected.
3. Insert a scratch diskette into the diskette drive.
4. Connect a jumper between TP-10 and TP-13 of the diskette drive logic board.
5. Power on the system.
6. Observe the strobe marks on the drive pulley under fluorescent lighting.

Note: The outer ring is for 60 hertz and the inner ring is for 50 hertz.

If the speed is correct, the appropriate ring of strobe marks will appear to stand still.

## Preliminary Speed Adjustment

Adjust the variable resistor on the servo board until the appropriate ring of strobe marks appears to stand still.

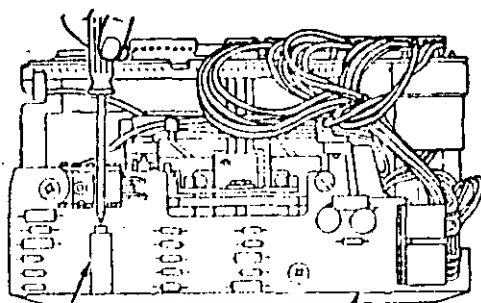

Variable Resistor

Servo Board

## TEST POINT REFERENCE PAGE

for

## TYPE 3 DISKETTE DRIVES

(Drives with a serial number prefix E)

## Test Point Reference Chart

Test Point	Location	Specifications
A	J6-2	5.0 Vdc with the diskette removed and the latch closed.
B	U10-4	Do the following: <ol style="list-style-type: none"> <li>1. Insert a diskette into drive A.</li> <li>2. Power off the system for 5 seconds.</li> <li>3. Power on the system.</li> <li>4. With the diskette inserted and the latch closed, a fluctuation of approximately 0.1 Vdc will occur after the beep at the end of the POST and will continue for as long as the spindle rotates.</li> </ol>
C	P7-1 (+)	1.5 Vdc minimum across these two test points.
D	P7-2 (-)	
E	N/A	Go to Step 038.
F	TP-1	As the LED initially lights, the voltage decreases by 0.2 Vdc.
G	P9-3	3 Vdc to 12 Vdc with the LED on.
H	P4-2	Decreases from 5.0 Vdc to 0 Vdc while inserting a diskette into the drive.

Requested Voltage Reading	Minimum	Maximum
Approximately 0 Vdc	0.0 Vdc	0.8 Vdc
Approximately 0.2 Vdc	0.15 Vdc	0.25 Vdc
Approximately 0.5 Vdc	0.5 Vdc	1.0 Vdc
Approximately 5.0 Vdc	2.0 Vdc	5.5 Vdc
Approximately 12 Vdc	11.2 Vdc	12.6 Vdc

## Test Point Locations

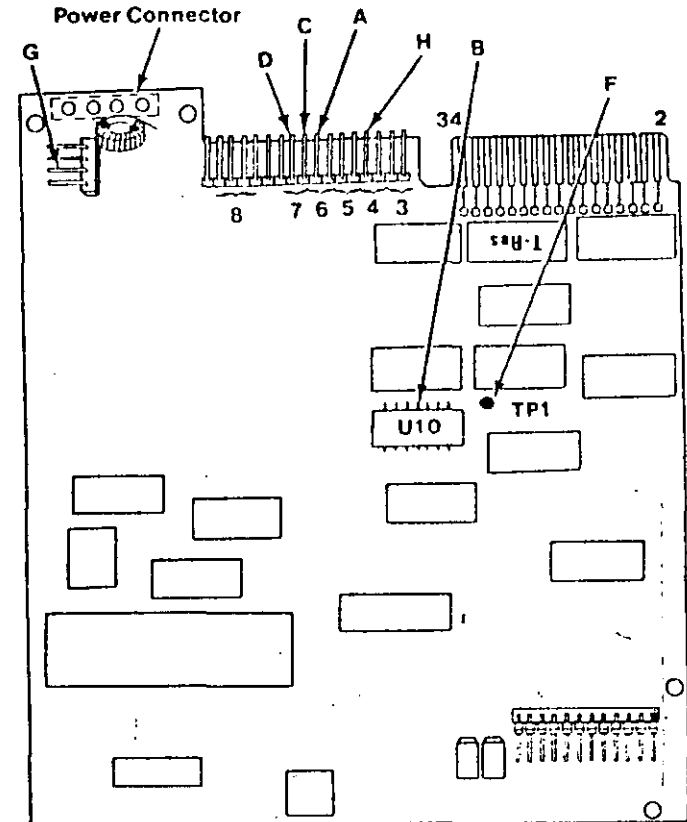

NCE PAGE

DRIVES

prefix E)

## Final Speed Check

1. Power off the system.
2. Insert the Advanced Diagnostic diskette into drive A.
3. Power on the system.
4. Run the Diskette Drive and Adapter test using the (RUN TESTS MULTIPLE TIMES) option.
5. When the Diskette Diagnostic menu appears, select option 4, (SPEED TEST).
6. The speed should fall within the range displayed.

The Type 3 diskette drive monitors its own speed and compensates accordingly. There are no speed adjustments on the drive. If the speed is not correct, an electrical or mechanical problem exists. Return to the MAP to isolate the failure.

## Preliminary Speed Check

1. Remove the diskette drive.
2. Plug the power connector into the diskette drive logic board. Leave the signal cable disconnected.
3. Insert a scratch diskette into the diskette drive.
4. Connect a jumper between pin 16 of the diskette drive signal connector and ground (use the frame as ground).
5. Power on the system.
6. Observe the strobe marks on the drive pulley under fluorescent lighting.

**Note:** The outer ring is for 60 hertz and the inner ring is for 50 hertz.

7. If the speed is correct, the appropriate ring of strobe marks will appear to stand still.

The Type 3 diskette drive monitors its own speed and compensates accordingly. There are no speed adjustments on the drive. If the speed is not correct, an electrical or mechanical problem exists. Return to the MAP to isolate the failure.

## MAP 0900: Parallel Port Start

Symptom Explanation	Conditions That Could Cause This Symptom
You have entered this MAP because you received a 9XX error code, or you have been directed here from another MAP.	<ul style="list-style-type: none"><li>• The Printer Adapter is failing.</li><li>• The Serial/Parallel Adapter is failing.</li><li>• The printer cable is failing.</li></ul>

### 001

Find your system type in the following figure and refer to the MAP indicated.

System Type	MAP
Personal Computer .....	MAP 0900: Printer Adapter
Personal Computer XT .....	MAP 0900: Printer Adapter
Portable PC .....	MAP 0900: Printer Adapter
Personal Computer AT .....	MAP 0900: Serial/Parallel Adapter - Parallel Port

Figure 1. System Identification

001 (continued)

**DID YOU RECEIVE AN ERROR MESSAGE?**

Yes No

002

You have successfully completed the Advanced Diagnostic tests. If you suspect an intermittent problem, start an error log. If you need instructions, refer to the Reference manual.

003

Replace the Primary Serial/Parallel Adapter.

---

## MAP 0900: Printer Adapter

Symptom Explanation	Conditions That Could Cause This Symptom
You have entered this MAP because you received a 9XX error code, or you have been directed here from another MAP.	<ul style="list-style-type: none"> <li>The printer adapter is failing.</li> </ul>

001

- Power off the system.
- Disconnect the printer cable from the adapter.
- Insert the Advanced Diagnostics diskette into drive A.
- Power on the system.
- Run the Printer Adapter tests. Use the (RUN TESTS ONE TIME) option.
- Follow the instructions on the screen. Do not power off the system during this test.

Note: Use wrap plug (IBM Part 8529228) when instructed to install the wrap plug.

### DID YOU RECEIVE AN ERROR MESSAGE?

Yes No

002

You have successfully completed the Advanced Diagnostic tests. If you suspect an intermittent problem, start an error log. If you need instructions, refer to the Reference manual.

003

Replace the printer adapter.

## MAP 0900: Serial/Parallel Adapter - Parallel Port

Symptom Explanation	Conditions That Could Cause This Symptom
You have entered this MAP because you received a 9XX error code, you suspect a Serial/Parallel Adapter - Parallel Port problem, or you have been directed here from another MAP.	<ul style="list-style-type: none"> <li>The adapter assigned as the "Primary Parallel Port" is failing.</li> </ul>

Ensure the following conditions exist:

1. An adapter is set for "Primary Parallel Port" operation.
2. If a second adapter with a parallel port is installed, it is set for "Alternate Parallel Port" operation.

001

- Power off the system.
- Disconnect the printer cable if it is attached to the parallel port set for primary operation.
- Insert the Advanced Diagnostics diskette into drive A.
- Run the Serial/Parallel - Parallel Port tests. Use the (RUN TESTS ONE TIME) option.
- Follow the instructions on the screen. Do not power off the system during this test.

Note: Use wrap plug (IBM Part 8529228) when instructed to install the wrap plug.

(Step 001 continues)

**023 (continued)**

- Power off the system.
- Remove the Fixed Disk and Diskette Drive Adapter from the system board.
- Power on the system.

Removal of the Fixed Disk and Diskette Drive Adapter results in a 601 error code, disregard this error.

**DID THE SYMPTOM REMAIN?**

Yes No

**024**

Replace the Fixed Disk and Diskette Drive Adapter. If that does not correct the problem, replace the system board.

**025**

- Power off the system.
- Remove the primary display adapter from the system board.
- Power on the system.

Removal of the primary display adapter results in one long and two short beeps during the POST.

**DID YOU RECEIVE ONE LONG AND TWO SHORT BEEPS?**

Yes No

**026**

Go to Step 028 in this MAP.

**027**

Replace the primary display adapter. If that does not correct the problem replace the system board.

**028**

(From Step 026 in this MAP)

- Power off the system.
- Wait 10 seconds.
- Power on the system.
- Check for a voltage of 2.4 to 5.2 Vdc between pins 1 and 5 (ground) at power supply connector P8.

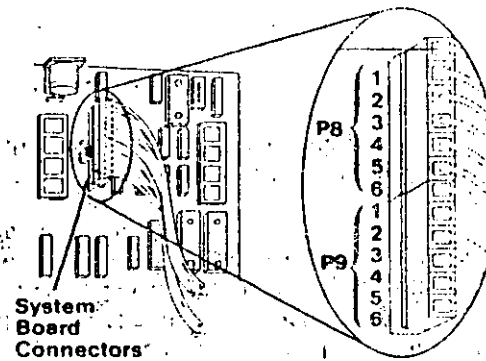

Figure 4. System Board Power Supply Connector

**DO YOU HAVE 2.4 TO 5.2 VDC BETWEEN PINS 1 AND 5?**

Yes No

**029**

Replace the power supply. If that does not correct the problem, replace the system board.

**030**

Replace the system board. If that does not correct the problem replace the power supply.