

VEANSE. JEUMA DE CABLEADO No ALM34MF 530 SD001

N°	FECHA	DIBUJO	REVISO	APROBADO	DESCRIPCION	ESTADO
F	17/10/94	NOVA	DRN	RIV	PUESTA AL DIA	BPE
E	07/07/93	NOE	DRN	RIV	VEANSE PAGINA : 4	BPE
D	18/05/93	RUS	DRN	RIV	VEANSE PAGINA : 4	BPE
C	10/05/93	RUS	DRN	RIV	VEANSE PAGINA : 4	BPE
B	27/08/92	RUS	DRN	RIV	VEANSE PAGINA : 4	BPE
A	22/04/92	NOL	DRN	JUI	PRIMERA EDICION	

N° de Control: AS-101-05-04

N° de Archivo:

ESCALA: **CEGELEC**

PROVEEDOR: **CEGELEC**

FORMATO: A3

N°: **P.2332A30000F**

ESPECIFICACION N°:

Division ERE P. 35, rue d'Alger - 97531 Lumbale Point Caillat - France

**COMISION FEDERAL DE ELECTRICIDAD**  
**CENTRAL TERMoeLECTRICA ADOLFO LOPEZ MATEOS**  
 2X350MW      Unidades 03 y 04

PLANTA DE AGUA  
 LAZOS DE REGULACION Y MEDICION



CTM-INGENIERIE

N° **ALM34MF.530SR001**

pagina 1/48

REV.	A	B	C	D	E	F												
THIS DOCUMENT IS CECELEC PROPERTY IT CANNOT BE USED, REPRODUCED TRANSMITTED AND /OR DISCLOSED WITHOUT PRIOR WRITTEN PERMISSION.																		
MICROFILM TEST																		

F0	DESIGNACION	INDICE DE REVISION						F0	DESIGNACION	INDICE DE REVISION								
		A	B	C	D	E	F			A	B	C	D	E	F			
01	PAGINA DE GUARDA	X	X	X	X	X	X	25	SISTEMA APA	1 / 2	X	X	X					
02	SUMARIO	X	X	X	X	X	X	26	SISTEMA APA	2 / 2	X	X						
03	SUMARIO	X	X	X	X	X	X	27	RESERVA									
04	LISTA DE REVISIONES	X	X	X	X	X	X	28	RESERVA									
05	RESERVA							29	SISTEMA SVA	1 / 2	X	X	X					
06	LEYENDA	X	X					30	SISTEMA SVA	2 / 2	X	X	X					
07	RESERVA							31	RESERVA									
08	RESERVA							32	SISTEMA FKF	1 / 2	X	X	X					
09	SISTEMA ABP	1 / 4	X	X				33	SISTEMA FKF	2 / 2	X	X	X					
10	SISTEMA ABP	2 / 4	X	X				34	RESERVA									
11	SISTEMA ABP	3 / 4	X	X				35	SISTEMA CRF	1 / 2	X	X	X					
12	SISTEMA ABP	4 / 4	X	X				36	SISTEMA CRF	2 / 2	X	X	X					
13	RESERVA							37	RESERVA									
14	SISTEMA ADG	1 / 3	X	X	X			38	SISTEMA ACO	1 / 1	X	X	X					
15	SISTEMA ADG	2 / 3	X	X	X			39	RESERVA									
16	SISTEMA ADG	3 / 3	X	X	X			40	SISTEMA AHP	1 / 2	X	X	X					
17	RESERVA							41	SISTEMA AHP	2 / 2	X	X	X					
18	SISTEMA CEX	1 / 3	X	X	X			42	RESERVA									
19	SISTEMA CEX	2 / 3	X	X	X			43	SISTEMA CVI	1 / 1	X	X	X					
20	SISTEMA CEX	3 / 3	X	X	X			44	RESERVA									
21	RESERVA							45	SISTEMA STR	1 / 1	X	X	X					
22	SISTEMA CAP	1 / 2	X	X	X			46	RESERVA									
23	SISTEMA CAP	2 / 2	X	X	X			47	SISTEMA SRI	1 / 1	X	X	X					
24	RESERVA							48	RESERVA									

SUMARIO

ALM34MF 530SR001

CEGELEC

P2332 A30000 - F

Division  
ERE P  
1000  
2  
3

Ce document propriété de CEGELEC ne doit pas être révisé, copié ou communiqué à des tiers sans son autorisation.





REV	FEL.	DESCRIPCION	REV	FECHA	DESCRIPCION
A	22/04/92	-PRIMERA EDICION			
B	26/08/92	PUESTA AL DIA SEGUN COMENTARIOS DE CEG-ALSTHOM : ( ALM/DIR/92 FB 2886 ) Y CFE : FECHA 23 JULI 1992			
C	10/05/93	PUESTA AL DIA , Y ANADIDO FONCION SIR Y SIT			
D	18/05/93	PUESTA AL DIA			
E	07/07/93	ANADIDO VALVULA CEX LCV002			
F	17/10/94	PUESTA AL DIA DESPUES RETORNO ASTILLERO			

LISTA DE REVISIONES

ALM34MF 530SR001

CEGELEC

Division  
ERE P











P 2332 A30000 - F

COPIA  
SER 4 6



# SIMBOLOS DE DIAGRAMA ESQUEMATICO











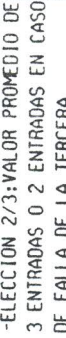

















## MODULOS DE INTERFASE

-  -SEÑAL DE ALTO NIVEL  
ENTRADA: 4-20 mA SALIDA: 1-5 V
-  -CONVERTIDOR DE SEÑAL BAJO NIVEL  
SALIDA: 1-5 V
-  -CONVERTIDOR CORRIENTE/TENSION  
CON ALIMENTACION DEL TRANSMISOR  
ENTRADA: 4-20 mA SALIDA: 1-5 V
-  -CONVERTIDOR CORRIENTE/TENSION  
ENTRADA: 4-20 mA SALIDA: 1-5 V
-  -TERMINAL DE ENTRADA LOGICA
-  -TERMINAL DE SALIDA LOGICA
-  -MODULO MEMORIA DE SALIDA
-  -MODULO DE AISLAMIENTO DE SALIDA
-  -CONVERTIDOR TENSION/CORRIENTE  
ENTRADA: 1-5 V SALIDA: 4-20 mA
-  -CONVERTIDOR TENSION/TENSION  
ENTRADA: 1-5 V SALIDA: 1-5 V
-  -CONVERTIDOR DE AISLAMIENTO SALIDA/ENTRADA  
ENTRADA: 4-20 mA SALIDA: 4-20 mA

## SIGNIFICADOS PARA MEDICION Y CONTROL

-  -SEÑAL ANALOGICA PRINCIPAL
-  -SEÑAL ANALOGICA SECUNDARIA
-  -SEÑAL BINARIA

## SIMBOLOS DE LAS TARJETAS MICRO.Z

- |   |   |   |   |
|---|---|---|---|
|    |  |    | -SEÑAL DE DESVIACION  |
|    | -SUMADOR  |    | -CONTROLADOR PI<br>(SE PUEDE PERSONIFICARLO)<br>I.O.P.P.I.P.D.P.I+D |
|    | -SELECTOR BAJO  |    | -FUNCION DE TIEMPO  |
|    | -SELECTOR ALTO  |    | -UMBRAL ALTO  |
|    | -MULTIPLICADOR  |    | -UMBRAL BAJO  |
|    | -DIVISOR  |    | -LOGICA "Y"   |
|    | -GENERADOR DE FUNCION   |    | -LOGICA "O"   |
|    | -EXTRACTOR DE RAIZ CUADRADA   |    | -PULSO AJUSTABLE  |
|    | -GANANCIA   |    | -RELE TEMPORIZADO   |
|   | -LIMITADOR  |  | -VARIADOR DE VELOCIDAD  |
|  | -BANDA MUERTA   |  | -TRANSMISOR ANALOGICO<br>(LETRA SEGUN<br>MEDICION FISICA)           |
|  | -SELECTOR NUMERICO  |  | -TERMOPAR   |
|  | -PUNTO DE AJUSTE NUMERICO   |  | -RESISTENCIA  |
|  | -OPERADOR PUNTO DE AJUSTE   |   |   |
|  | -OPERADOR ESTACION A/M  |   |   |

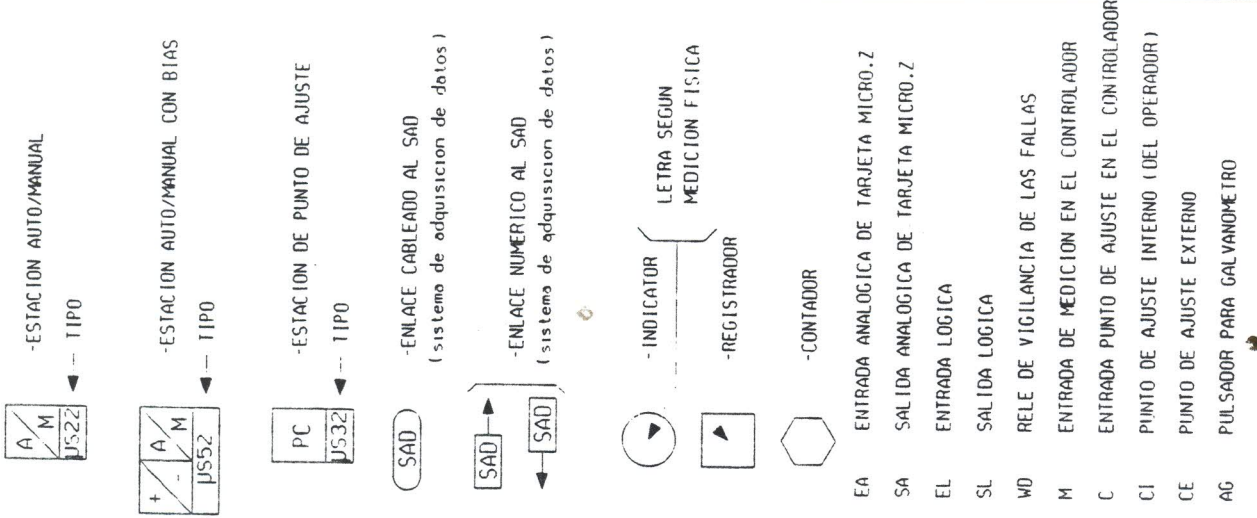

ALM34MF 530SR001  
 CEGELEC  
 Division ERE P  
 P 2332 A3000 - B  
 6 6 9  
 00 HUSZL 9/8/8

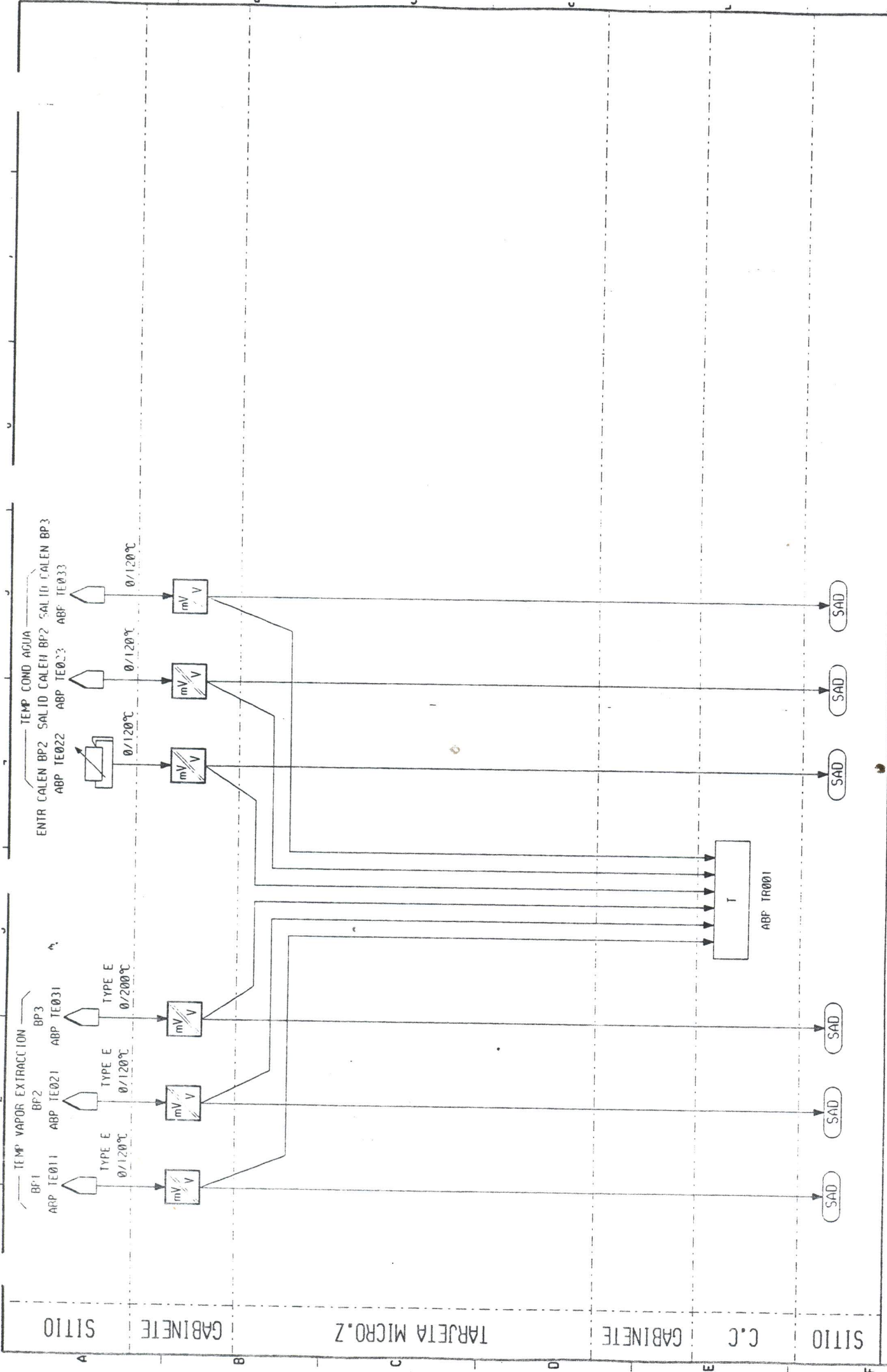

LAZO DE REGULACION: ABP 1 / 4  
 GABINETE: KR0001AR  
 TARJETA:

ALM34MF 530SR001

CEGELEC

Division ERE P

P 2332 A30000 - B

9 9 10

RUSCZL 5045

De document propiedad de CEGELEC, no darf para otro utilizo, copia, re-creacion o cualquier otro uso no autorizado.



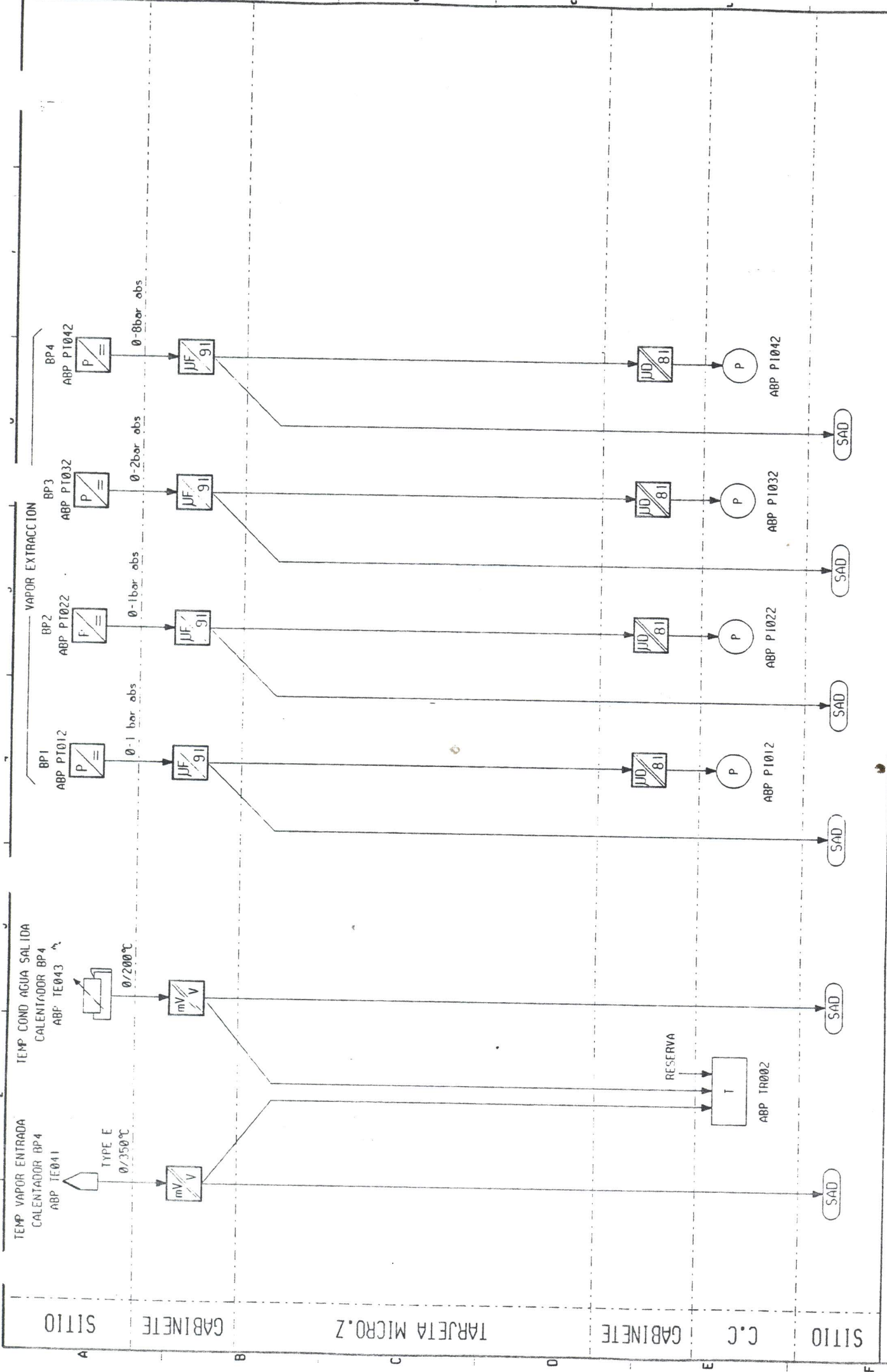

LAZO DE REGULACION: ABP 2 / 4  
 GABINETE: KRG001AR  
 TARJETA:

ALM34MF 530SR001

CEGELEC

Division ERE P  
 P 2332 A30000 - B

80 F05L2L9049

Ce document appartient à CEGELEC ne doit pas être utilisé, copié ou communiqué à des tiers sans son autorisation.

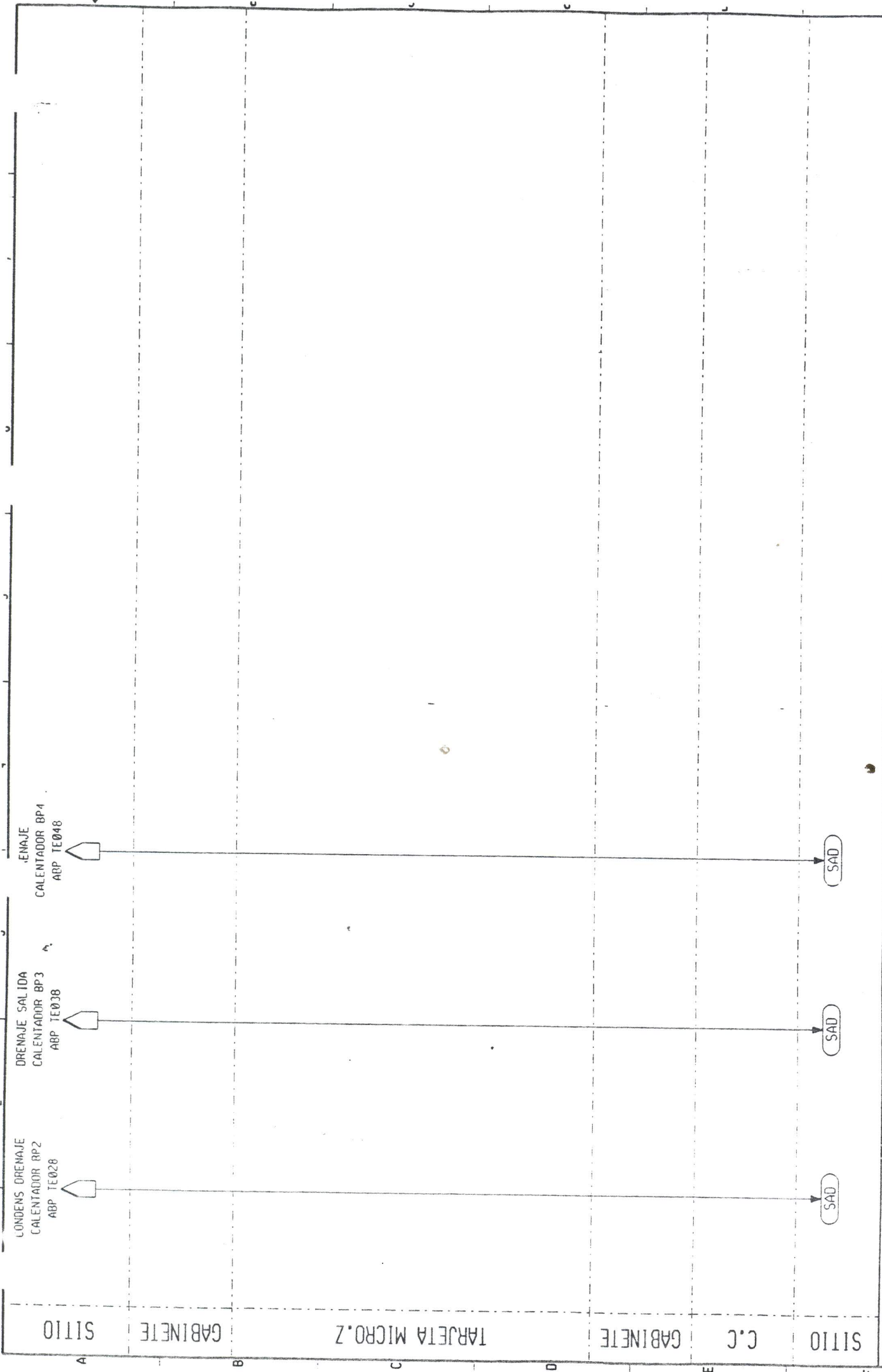

LAZO DE REGULACION: ABP 3 / 4  
 GABINETE:  
 TARJETA:

ALM34NF 530SR001

Division  
 ERE P  
 CEGELEC  
 P 2332 A30000 - B  
 FOLIO 11  
 DE 12  
 00 F051279009

Ce document propriété de CEGELEC ne doit pas être utilisé, copié ou communiqué à des tiers sans son autorisation.



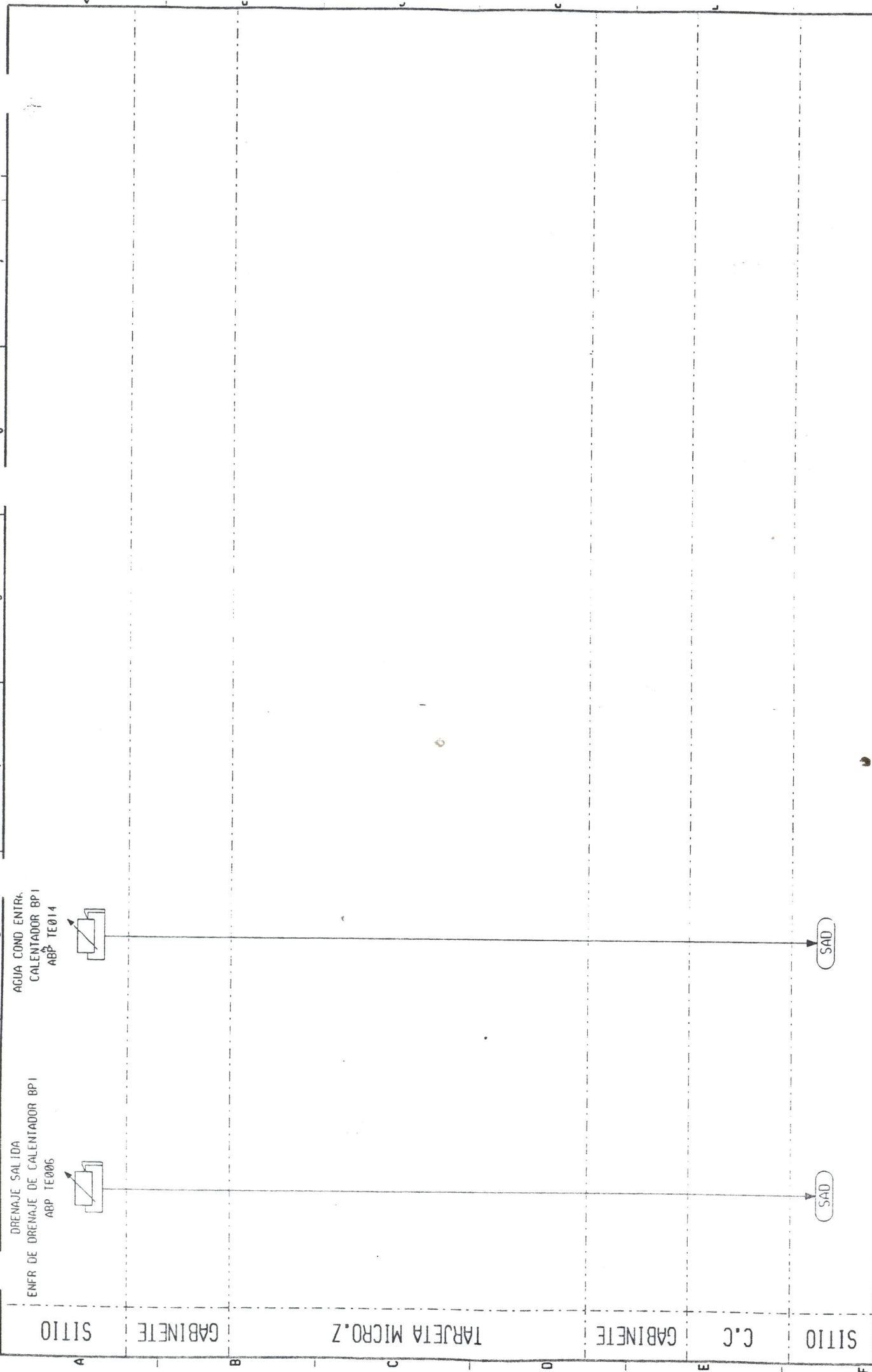

LAZO DE REGULACION: ABP 4 / 4 CABINETE: TARJETA:		ALM34MF 530SR001	CEGELEC P 2332 A30000 - B	División ERE P 12 14 12 14 12 14
--	--	------------------	------------------------------	--

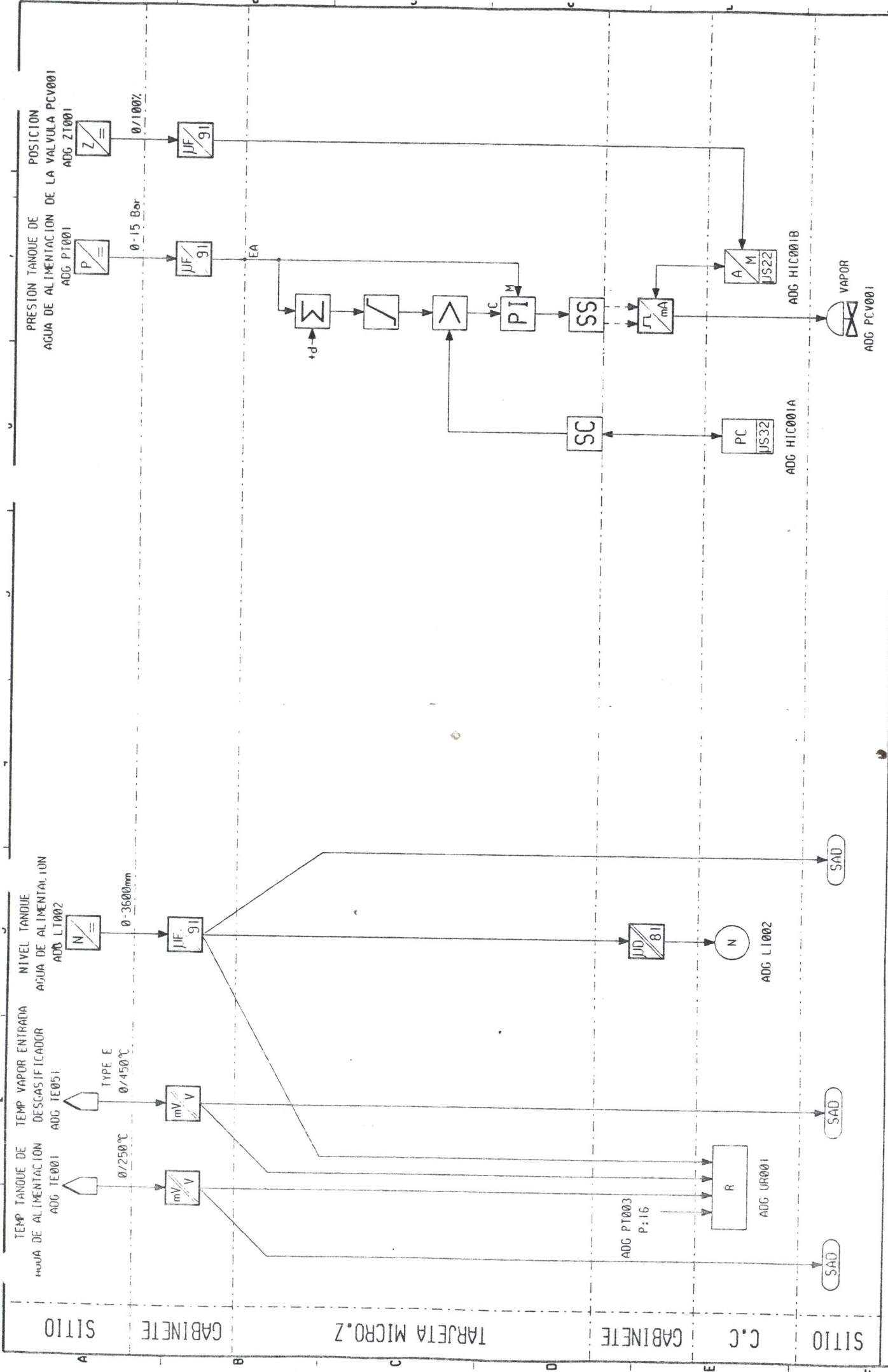

Division ERE P		P 2332 A30000 - C	14 15
CEGELEC			
ALM34MF 530SR001		14 15	
Lazo de Regulacion: ADG 1 / 3		GABINETE: KRC001AR	
GABINETE: KRC001AR		TARJETA: 181	

De document propriété de CEGELEC ne doit pas être utilisé, copié ou communiqué à des tiers sans son autorisation.



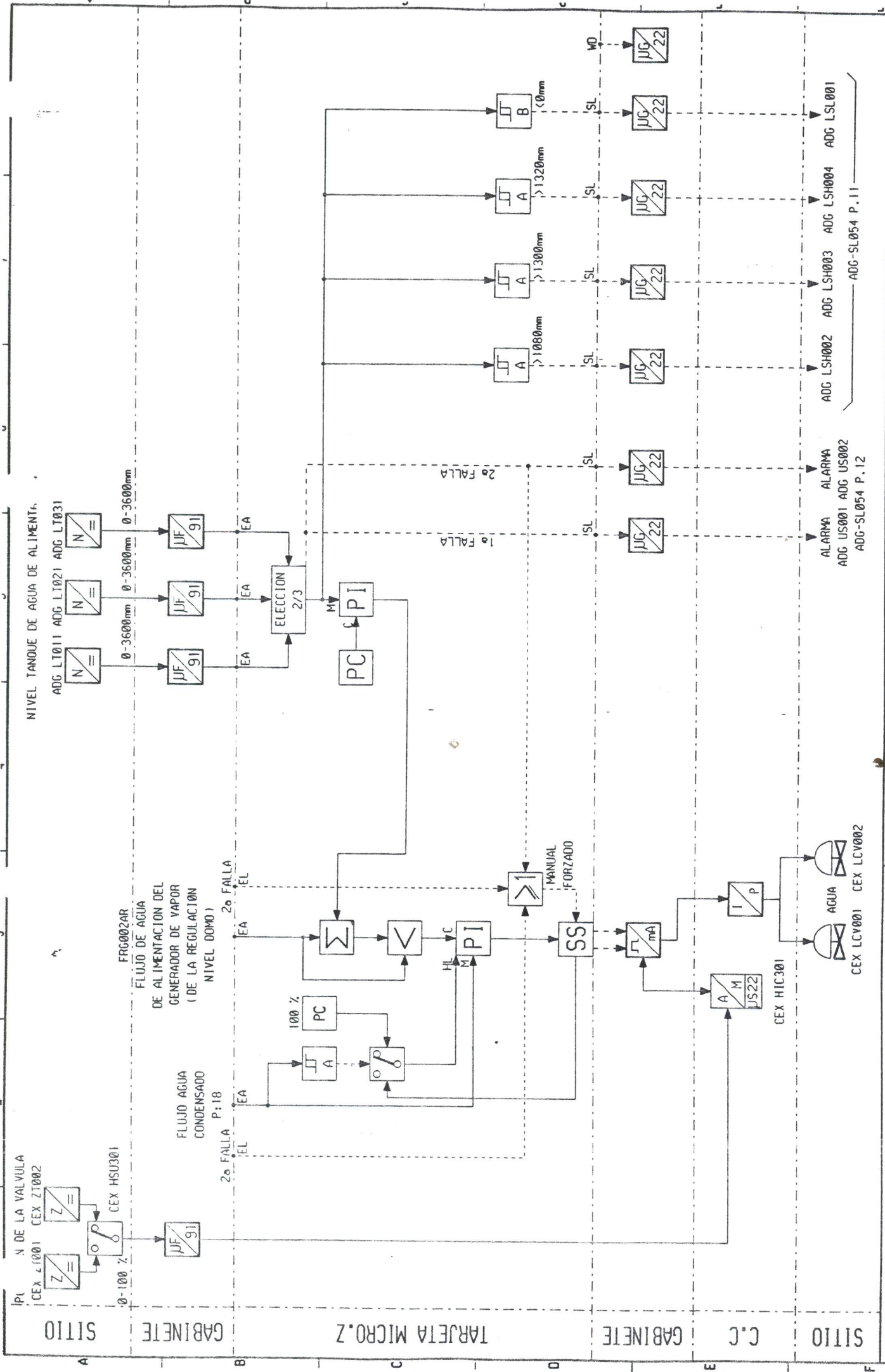

SITIO

GABINETE

TARJETA MICRO.Z

GABINETE

C.C.

SITIO

LAZO DE REGULACION: ADG 2 / 3  
GABINETE: KRG001AR  
TARJETA: 181

ALM34NF 530SR001

CEGELEC

P 2332 A30000 - F

Division	ERE P
SAFID	15
VOP	16

Os document propiedad de CECELEC no doit pas sere utilise, copie ou contrecopie a des fins sans son autorisation.

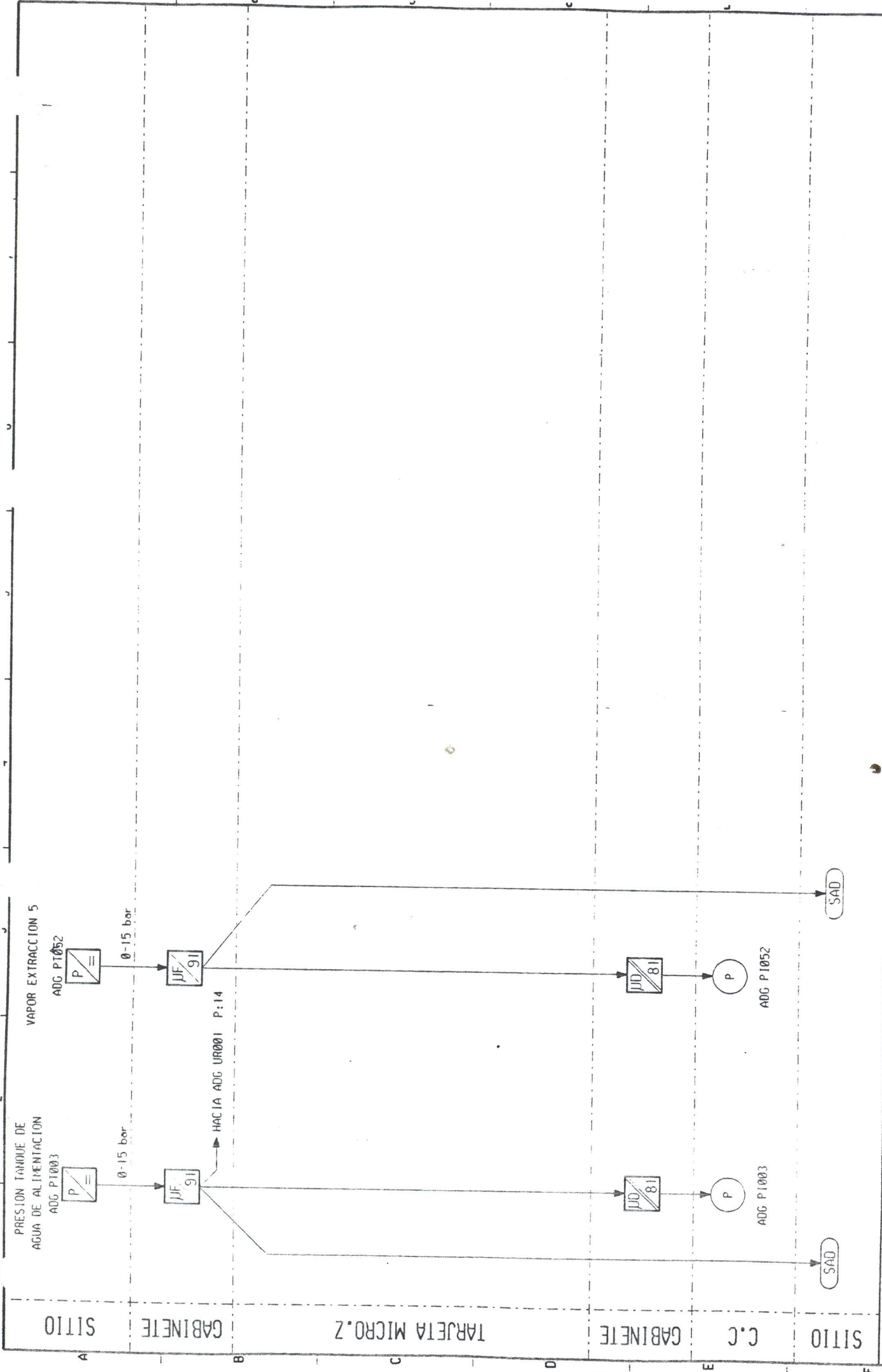

SITIO

GABINETE

TARJETA MICRO.Z

GABINETE

C.C

SITIO

LAZO DE REGULACION: ADG 3 / 3  
 GABINETE: KRC001AR  
 TARJETA:

ALM34MF 530SR001

Division  
 ERE P  
**CEGELEC**  
 P2332 A30000 - B  
 FOLIO 16  
 SERIE 18  
 8052219042

Un document propriété de CECELEC ne doit pas être utilisé, copié ou communiqué à des tiers sans son autorisation.



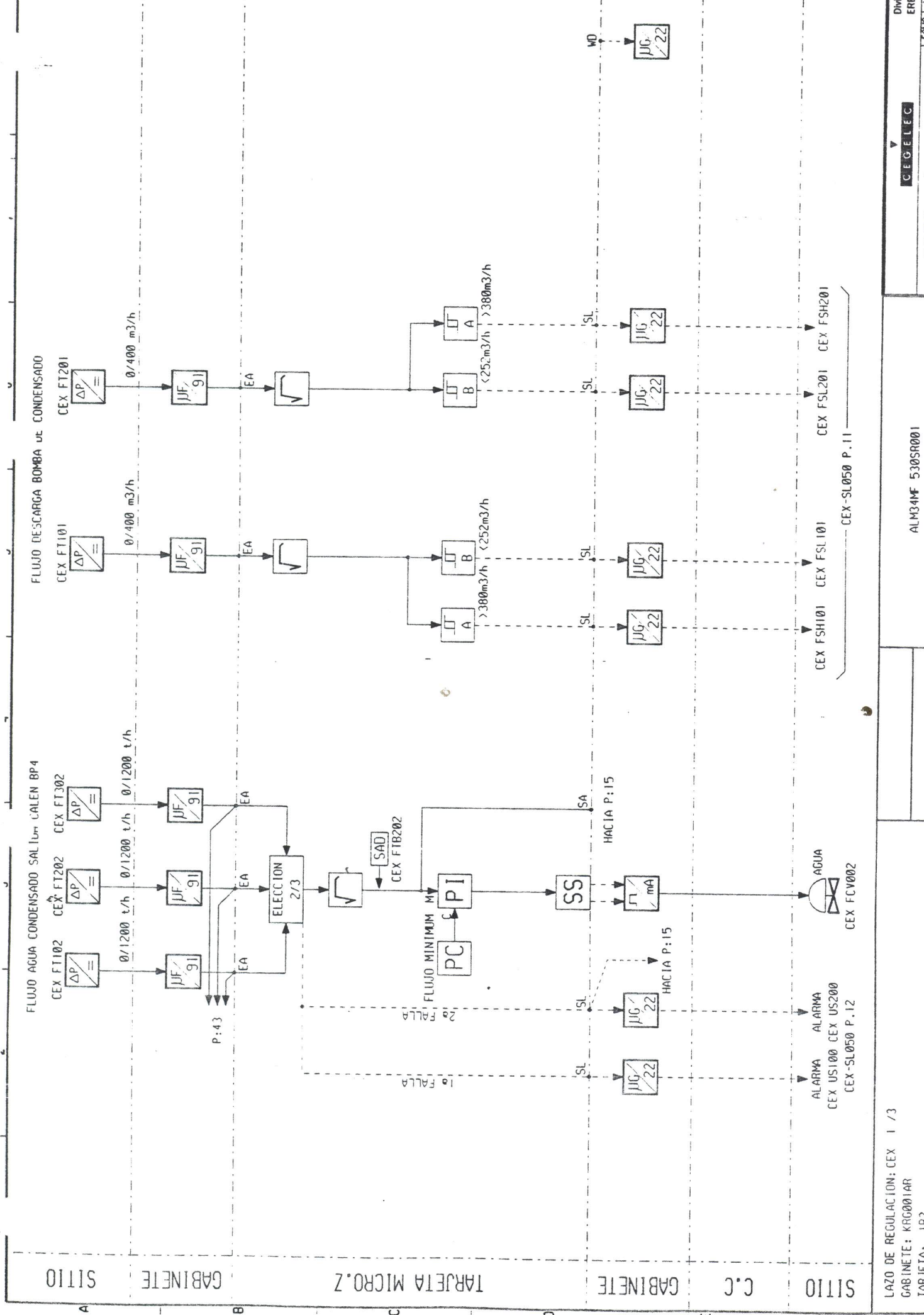

Division ERE P	C E G E L E C
P 2332 A30000 - C	18 19
ALM34NF 530SR001	
LAZO DE REGULACION: CEX 1 / 3 GABINETE: KRG001AR TARJETA: 1B2	

Ce document propriété de CEGELEC ne doit pas être utilisé, copié ou communiqué à des tiers sans son autorisation.

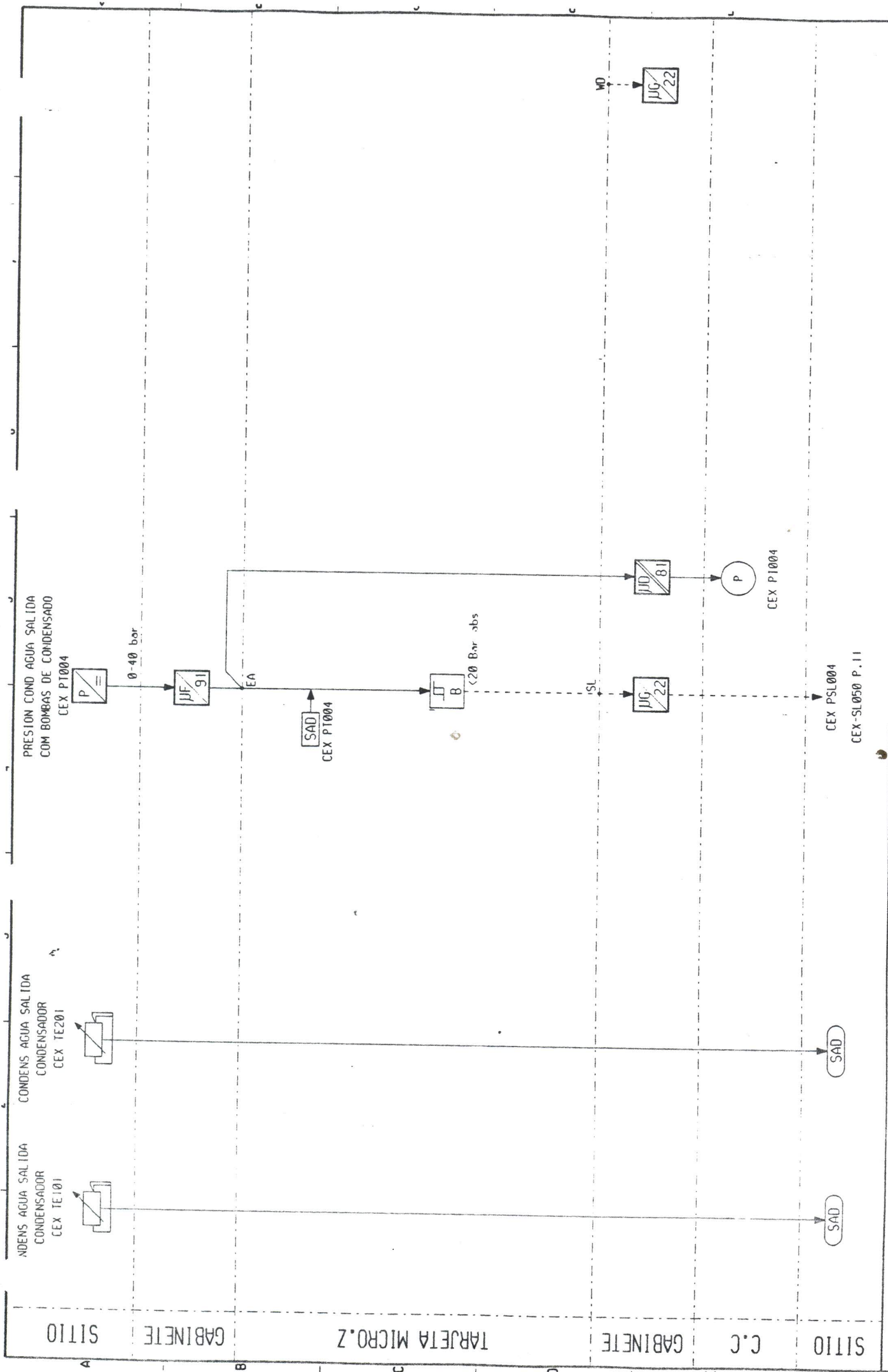

Division: ERE P

CEGELEC

P 2332 A30000 - C

ALM34MF 530SR001

LAZO DE REGULACION: CEX 2 /3

GABINETE: KR0001AR

TARJETA: 1B7

1910 19 19 20

80 FUSL21 9874

De document propriété de CEGELEC, ne doit pas être utilisé, copié ou communiqué à des tiers sans son autorisation.

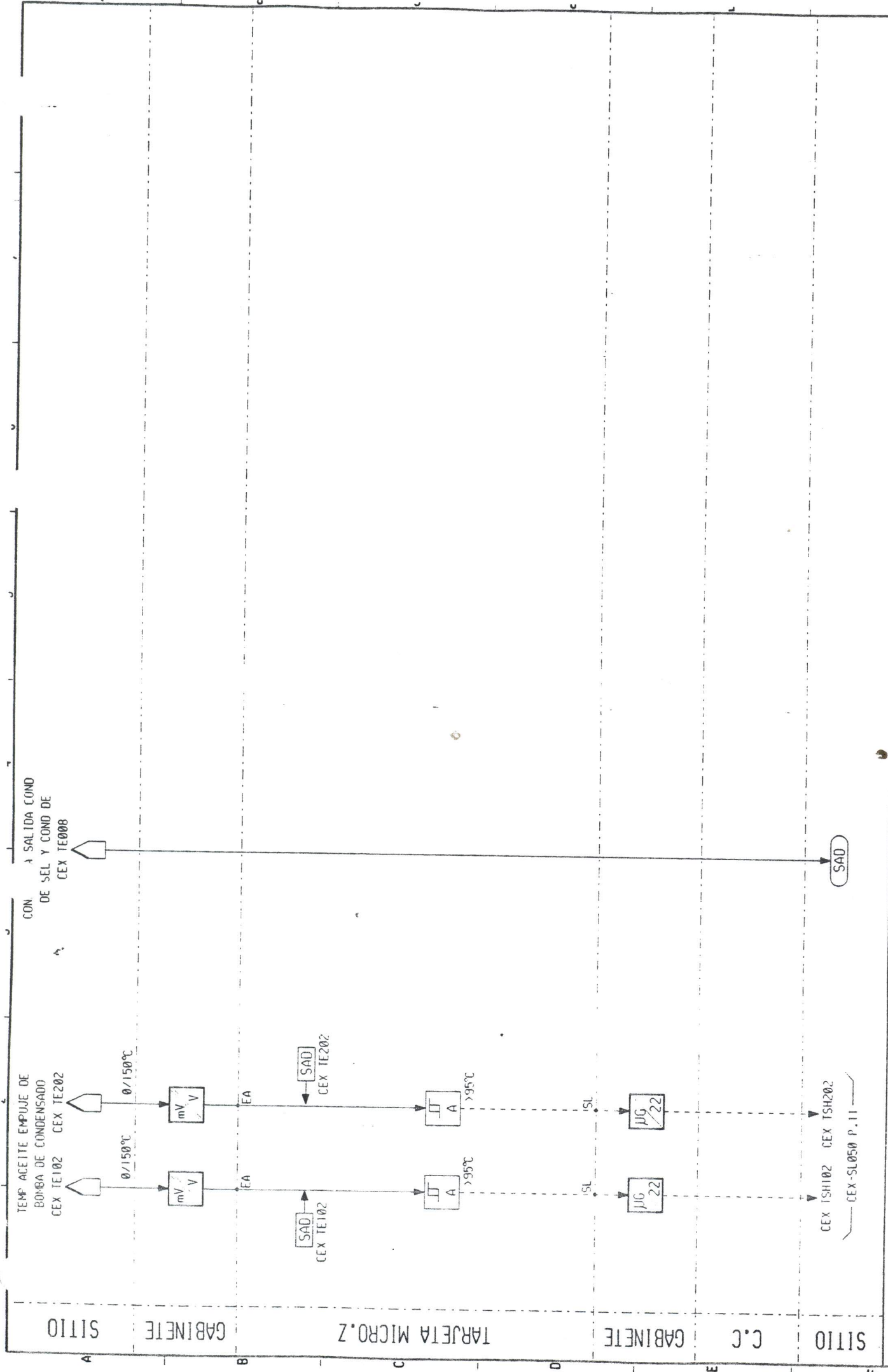

LAZO DE REGULACION: CEX 3 / 3  
 GABINETE: KRG001AR  
 TARJETA: 1B7

ALM34MF 530SR001

CEGELEC  
 P2332 A30000 - C

Division ERE P  
 5049 VOP  
 20 22

RUSCZL 9049

Ce document propriété de CEGELEC ne doit pas être utilisé, copié ou communiqué à des tiers sans autorisation.



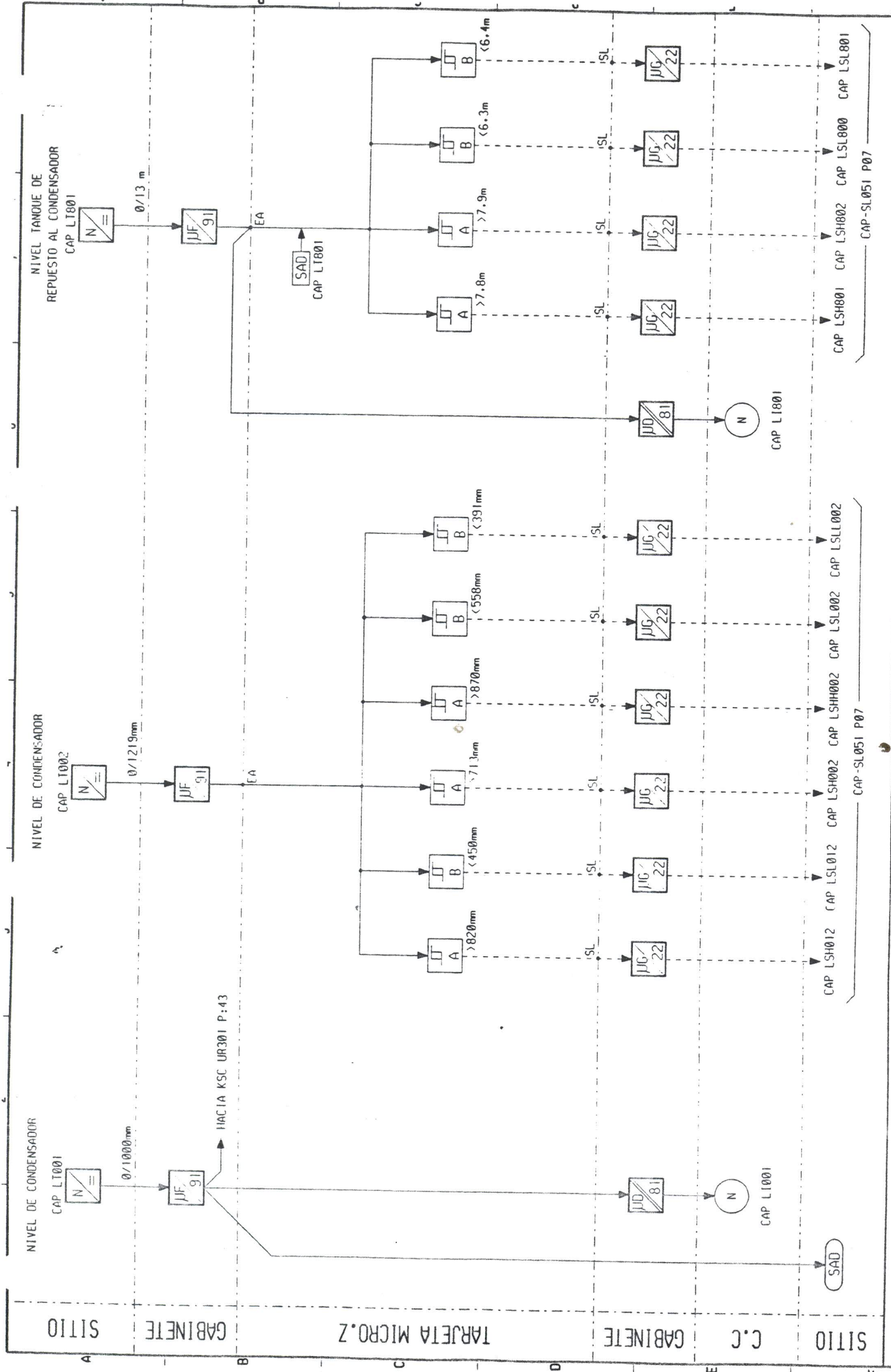

Division  
ERE P

ALM34MF 5305R001

P2332 A30000 - C

CEGELEC

LAZO DE REGULACION: CAP 1 / 2  
GABINETE: KRG001AR  
TARJETA: 1B7

10	11	12	13	14	15	16	17	18	19	20	21	22	23
----	----	----	----	----	----	----	----	----	----	----	----	----	----

De document propriété de CEGELEC ne doit pas être utilisé, copié ou communiqué à des tiers sans autorisation.

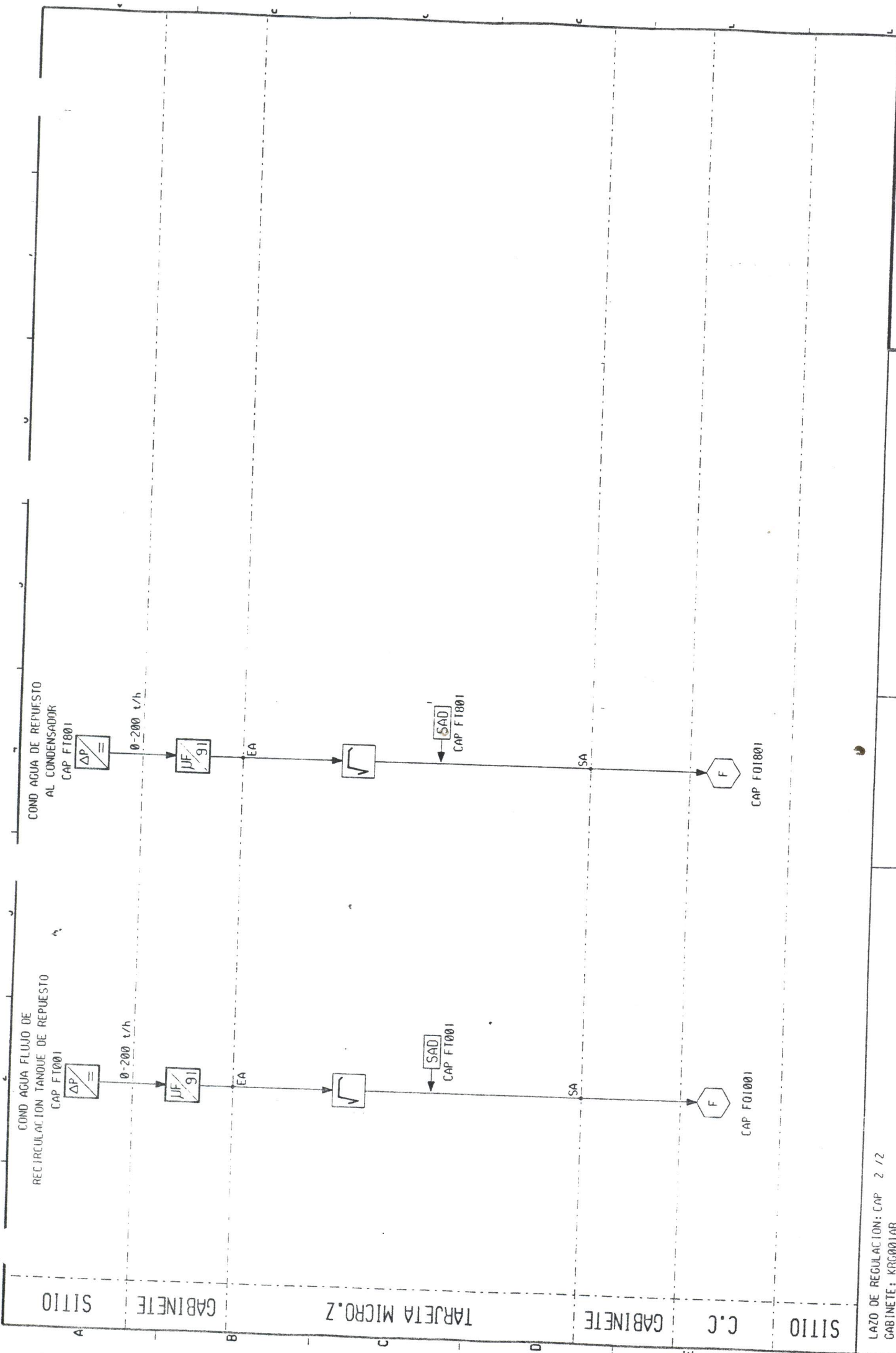

SITIO

GABINETE

TARJETA MICRO.Z

GABINETE

C.C

SITIO

LAZO DE REGULACION: CAP 2 / 2  
 GABINETE: KRG001AR  
 TARJETA: 188

ALM34NF 530SR001

CEGELEC

P 2332 A30000 - C

Division  
ERE P

23

25

SITIO

GABINETE

TARJETA MICRO.Z

GABINETE

C.C

SITIO

LAZO DE REGULACION: APA 1 72  
GABINETE: FR0002AR  
TARJETA: 2C2

APA PSL001  
APA-SL049 P.08

APA FSL102  
APA-SL055 P.10

APA UI101  
APA-SL056 P.10

APA FSL202  
APA-SL054 P.10

APA UI301  
APA-SL054 P.10

APA SE101  
APA SE201  
APA SE301

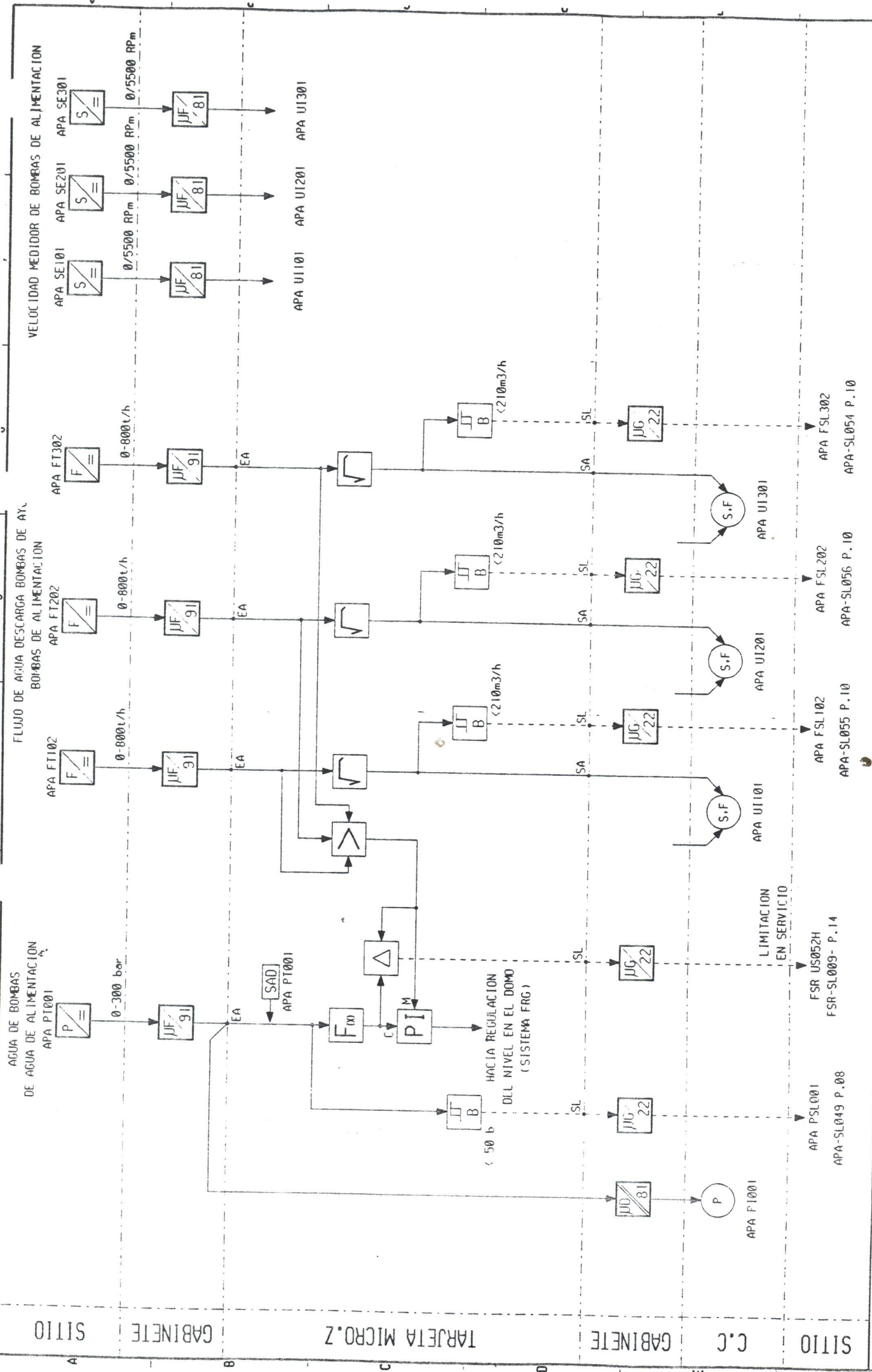

Division  
ERE P

CEGELEC  
P2332 A3000 - C

ALM34MF 530SR001

25 26

00 FUSL71 9074

Ca document propriété de CEGELEC ne doit pas être utilisé, copié ou communiqué à des tiers sans son autorisation.



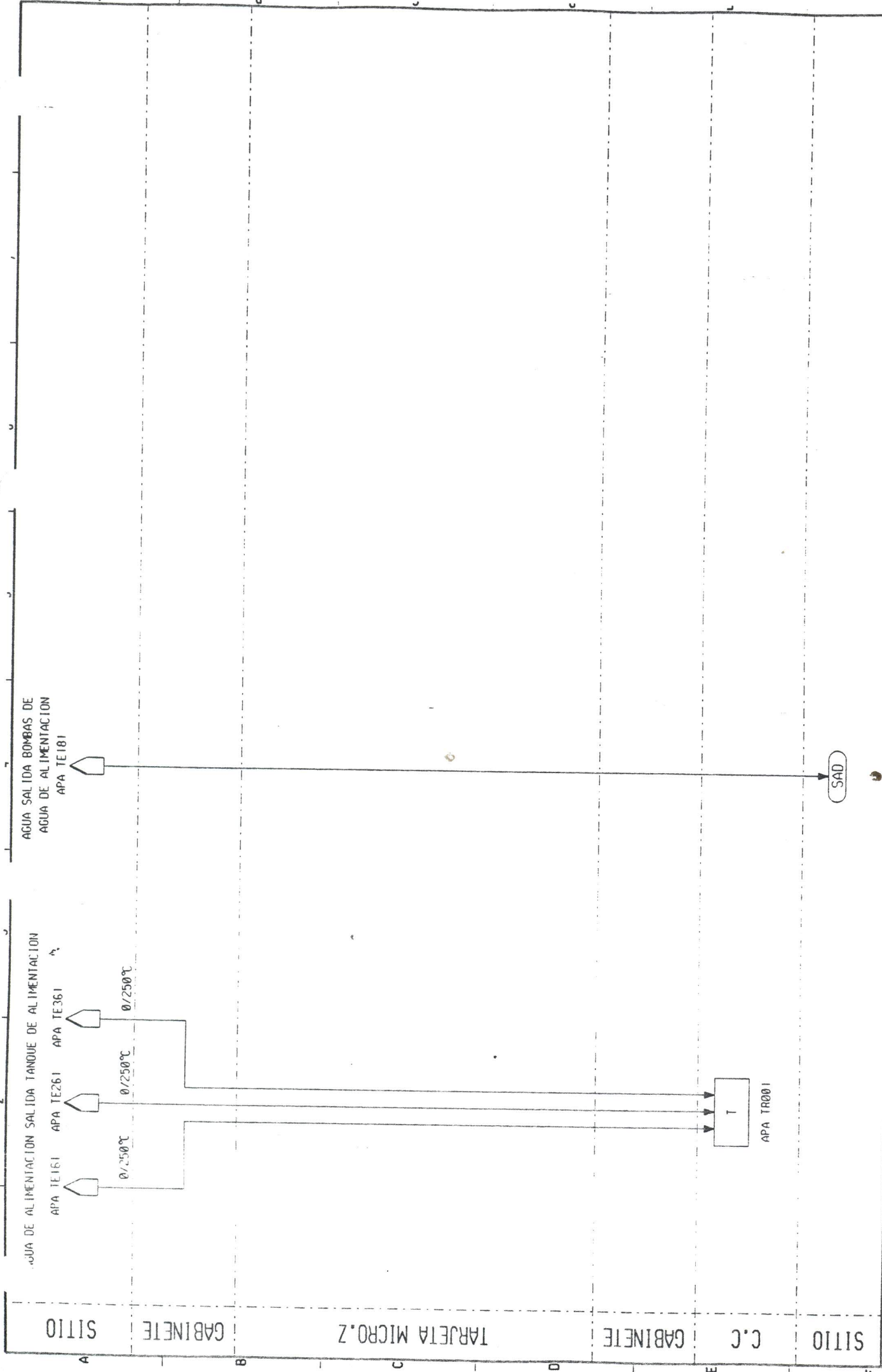

SITIO

GABINETE

TARJETA MICRO.Z

GABINETE

C.C

SITIO

LAZO DE REGULACION: APA ? 72  
 GABINETE:  
 TARJETA:

CEGELEC

P 2332 A30000 - B

Division  
 ERE P  
 EQUIP  
 26  
 29

ALM34MF 530SR001

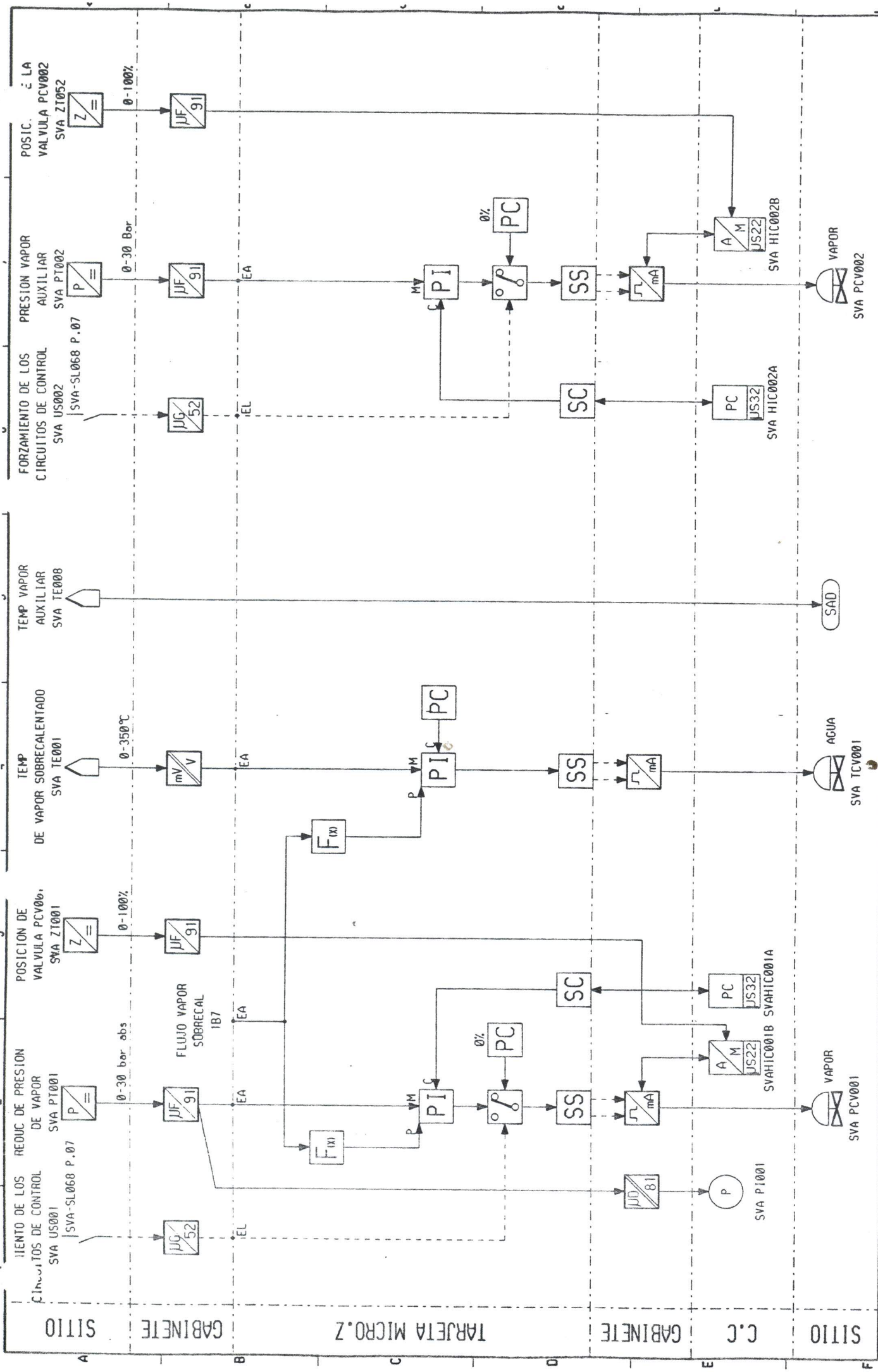

SITIO GABINETE TARJETA MICRO.Z GABINETE C.C SITIO	HIENTO DE LOS CIRCUITOS DE CONTROL SVA US001 SVA-SL068 P.07	REDUC DE PRESION DE VAPOR SVA PT001 SVA-SL068 P.07	POSICION DE VALVULA PCV001 SVA ZT001	TEMP DE VAPOR SOBRECALENTADO SVA TE001	TEMP VAPOR AUXILIAR SVA TE008	FORZAMIENTO DE LOS CIRCUITOS DE CONTROL SVA US002 SVA-SL068 P.07	PRESION VAPOR AUXILIAR SVA PT002	POSIC. VALVULA PCV002 SVA ZT052			
LAZO DE REGULACION: SVA 1 / 2 GABINETE: KRG001AR TARJETA: 1B3	ALM34MF 530SR001				P2332 A30000 - F						
Division ERE P								EQUIP SREP 29		30	

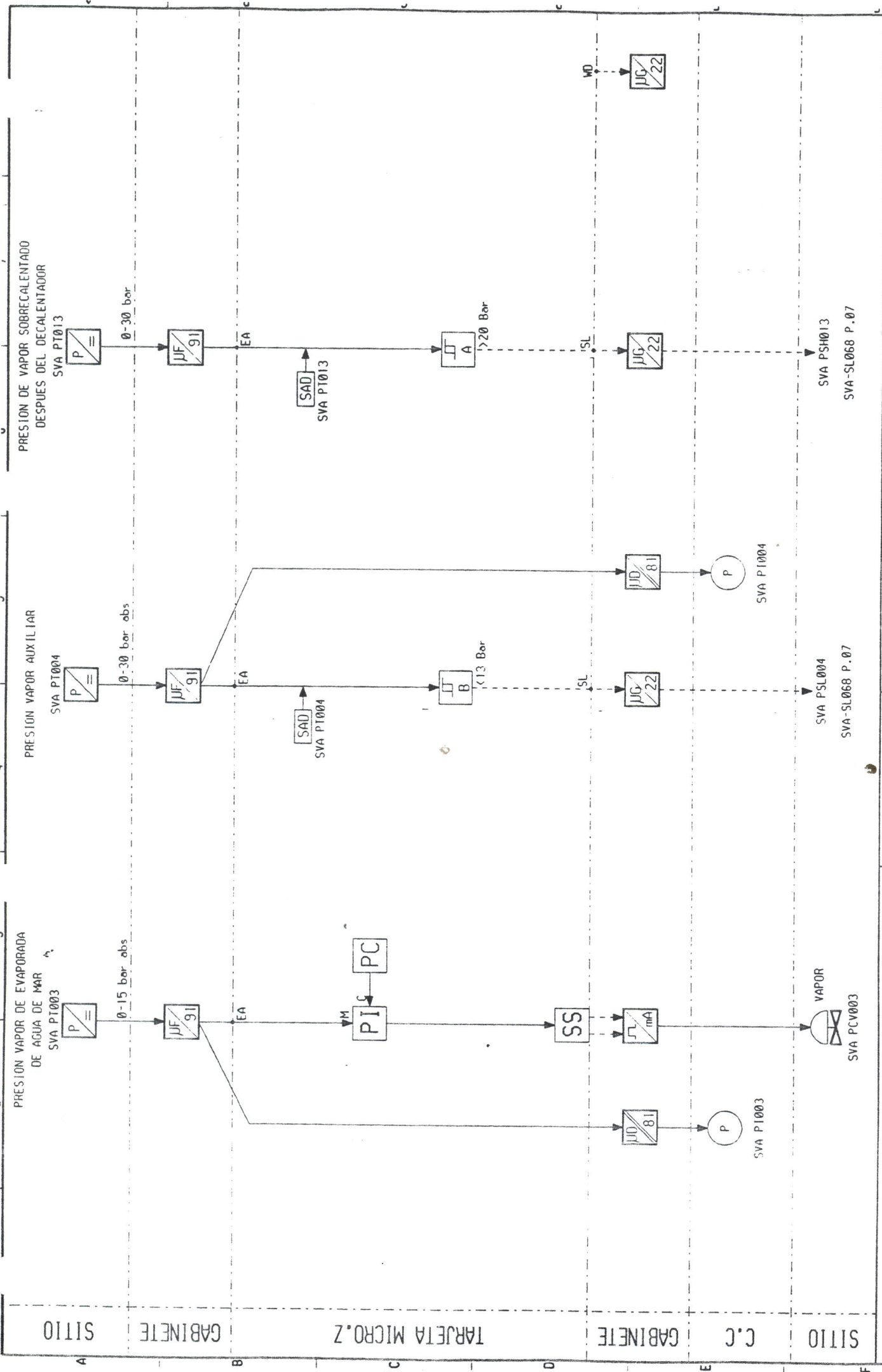

SITIO	AI M34MF 530SR001	Division ERE P
GABINETE		1010
TARJETA MICRO.Z		30
GABINETE		3.
C.C		
SITIO		

LAZO DE REGULACION: SVA 2 / 2  
GABINETE: KRC001AR  
TARJETA: 1B3

CEGELEC  
P 2332 A3000 - C  
HUSCZL3045

Ce document propriete de CEGELEC ne doit pas être utilisé, copié ou communiqué à des tiers sans son autorisation.



NIVEL DE TANQUE DE DIA  
DE ACEITE COMBUSTIBLE  
FKF LI502



Ø.75-13.55 m



EA

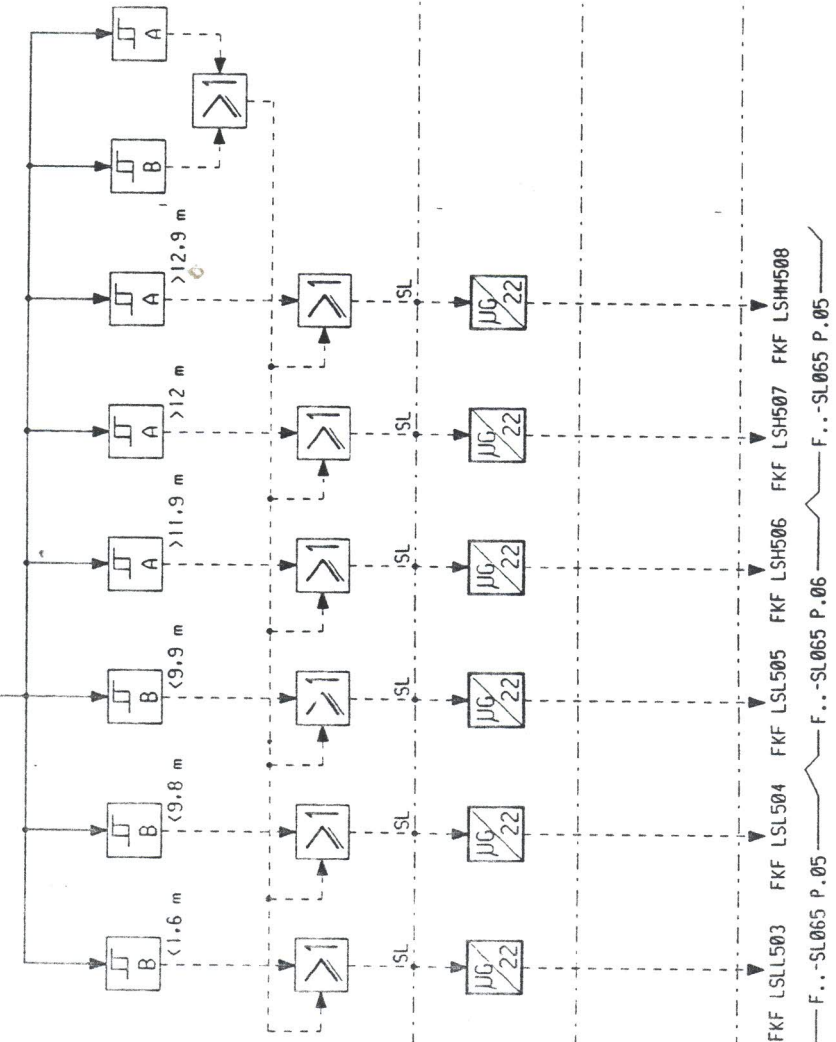

FKF LSL503 FKF LSL504 FKF LSL505 FKF LSH506 FKF LSH507 FKF LSH508  
F...-SL065 P.05 F...-SL065 P.06 F...-SL065 P.05

SITIO

GABINETE

TARJETA MICRO.Z

GABINETE

C.C

SITIO

LAZO DE REGULACION: FKF 1 / 2  
GABINETE: KRG001AR  
TARJETA: 1B8

ALM34MF 530SR001

P 2332 A30000 - F

Division  
ERE P  
VOR  
32  
33

NIVEL DE TANQUE DE ALMACENAMIENTO  
DE ACEITE COMBUSTIBLE  
FKF LT802

0,4-15,03 m

EA

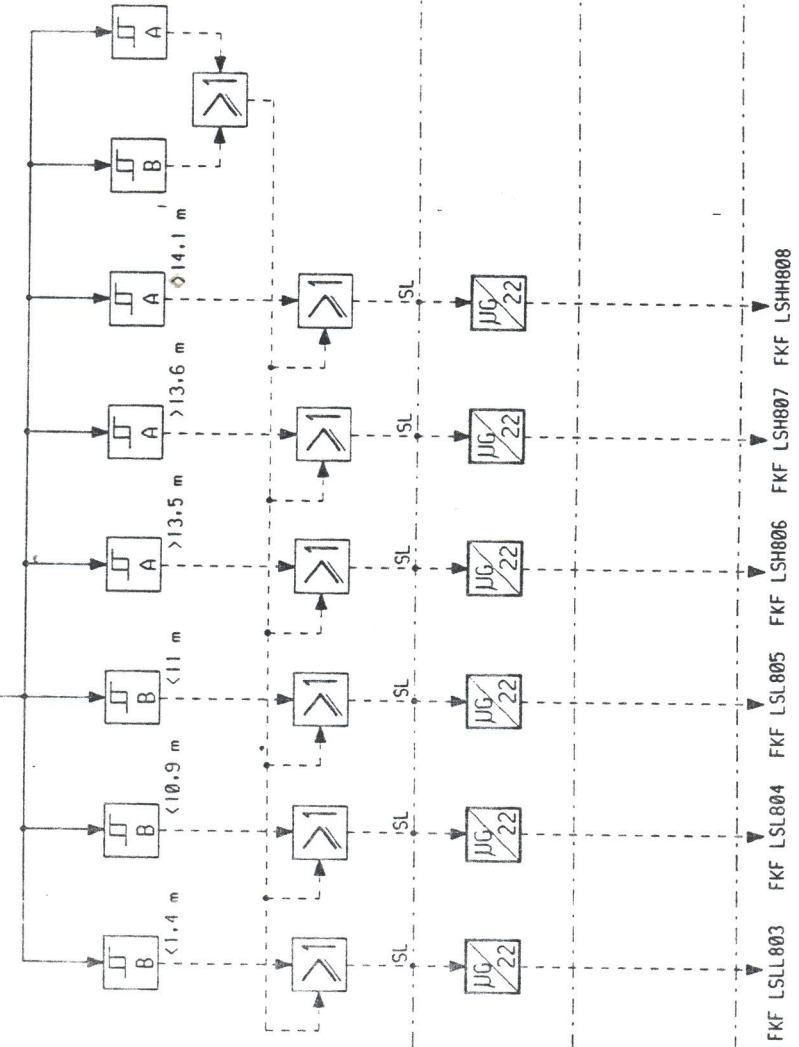

FKF LSL803 FKF LSL804 FKF LSL805 FKF LSH806 FKF LSH807 FKF LSH808  
F..-SL065 P.05

WD  
JUG 22

SITIO

GABINETE

TARJETA MICRO.Z

GABINETE

C.C.

SITIO

LAZO DE REGULACION: FKF 2 / 2  
GABINETE: KRC001AR  
TARJETA: 188

CEGELEC

ALM4NF 5305R001

P 2332 A30000 - F

Division  
ERE P  
EQUIP  
33 35

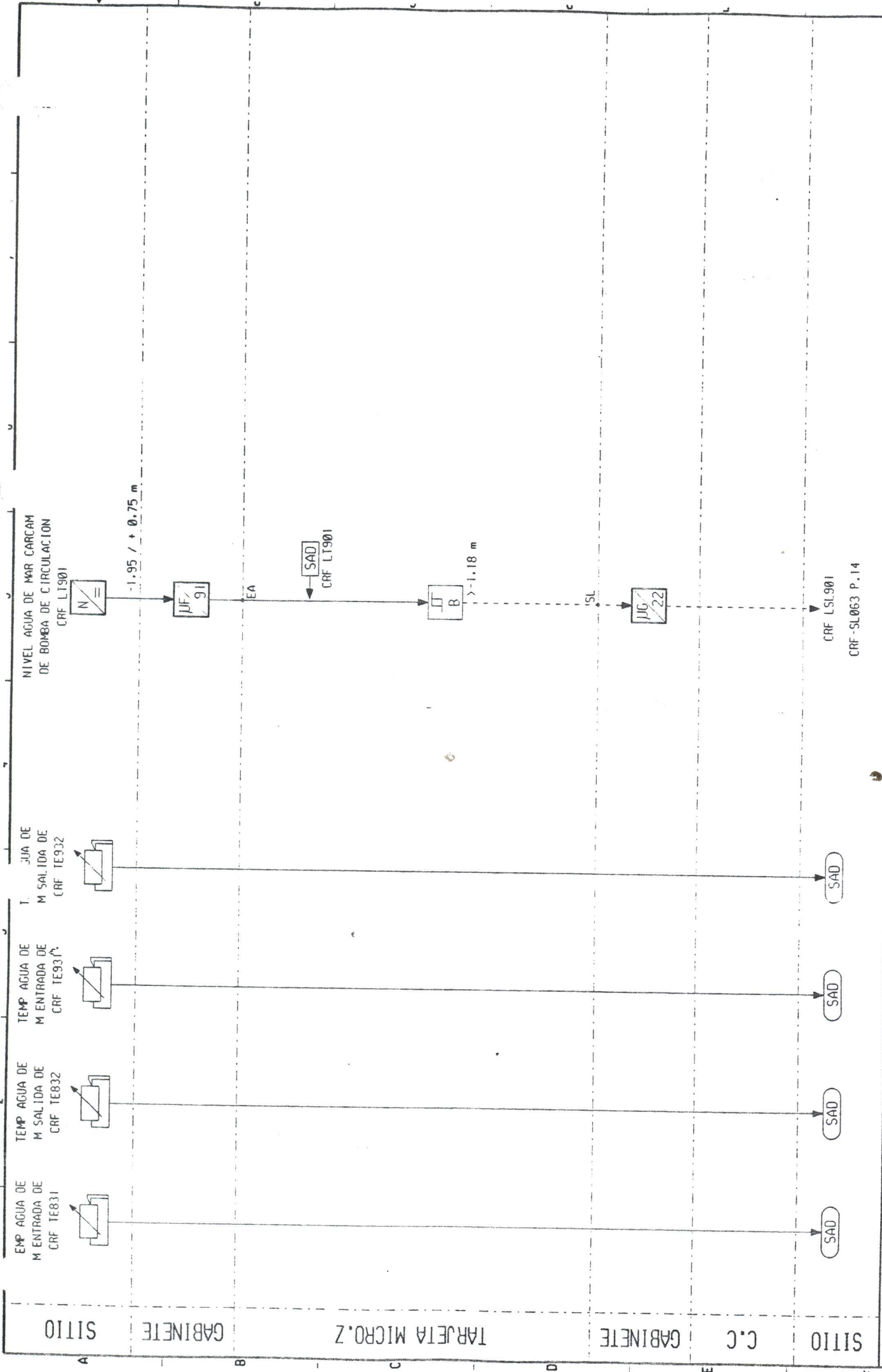

SITIO

GABINETE

TARJETA MICRO.Z

GABINETE

C.C

SITIO

LAZO DE REGULACION: CRF 1 72  
 GABINETE: KR0001AR  
 TARJETA: 187

CEGELEC

P2332 A30000 - C

División ERE P  
 35 36  
 RUSCZL 9099

ALM34MF 530SR001



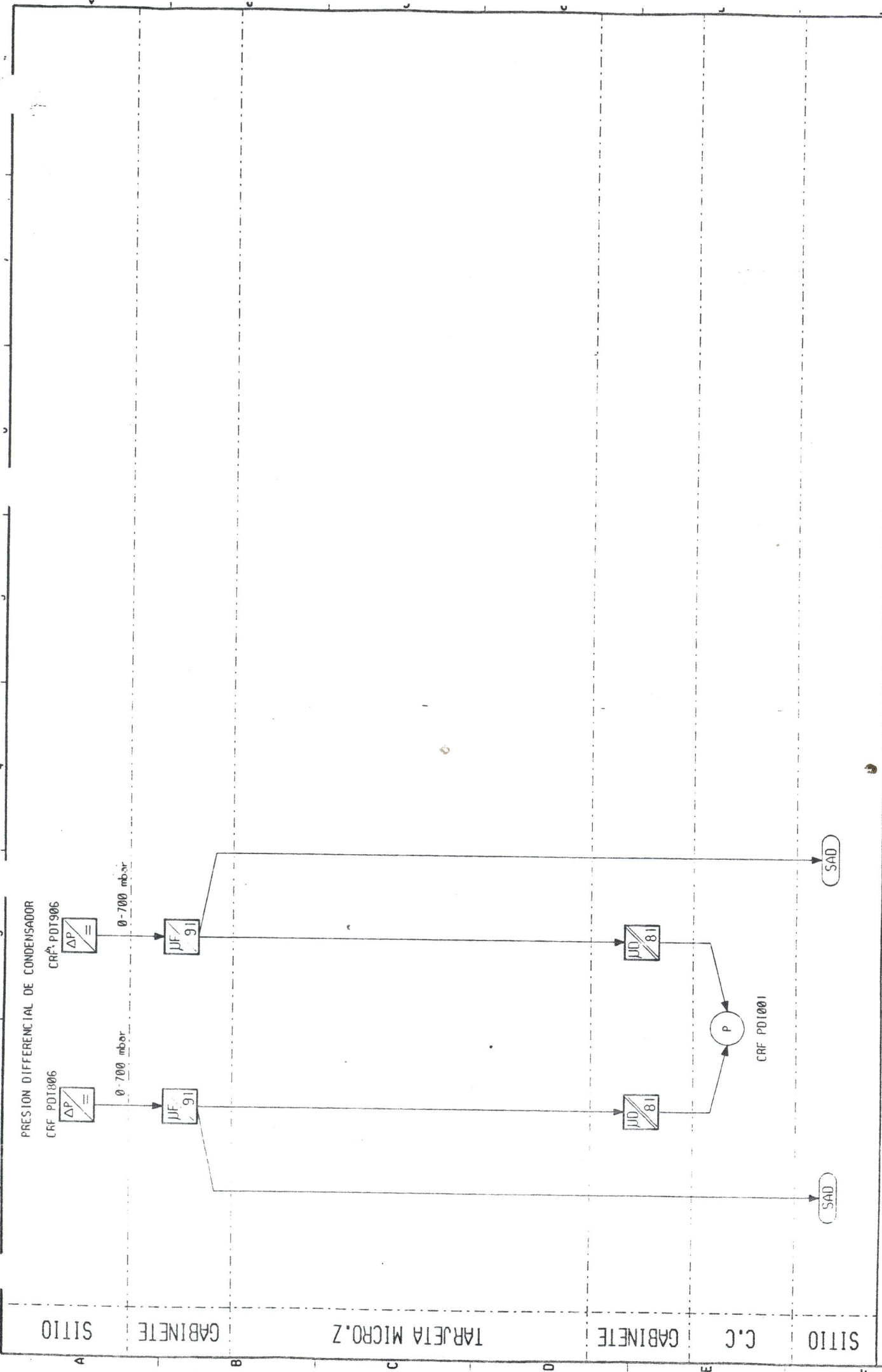

Division  
ERE P

C E G E T E C

P 2332 A30000 - B

ALM34MF 530SR001

LAZO DE REGULACION: CRF 2 / 2  
GABINETE: KRG001AR  
TARJETA:

Division  
ERE P

CRF 36 36 38

RUSLZ 3023

Document propriété de CEGELEC ne doit pas être utilisé, copié ou communiqué à des tiers sans son autorisation.

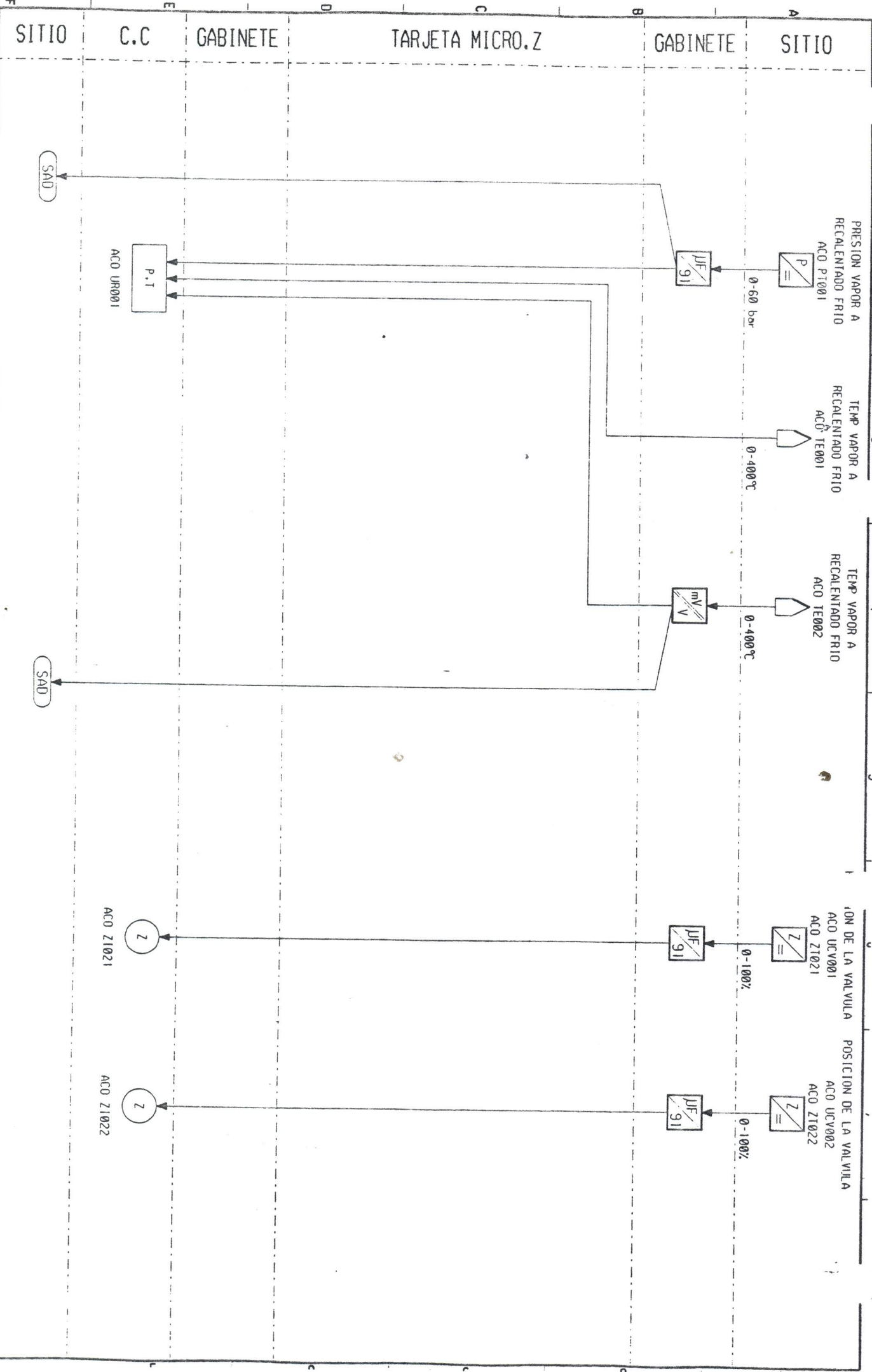

SITIO  
LAZO DE REGULACION: ACO 1 / 1  
GABINETE: KRC001AR  
TARJETA:

ALM34M 5305R001

**CEGELEC**

**P2332 A30000 - C**

Division  
ERE P  
38  
40

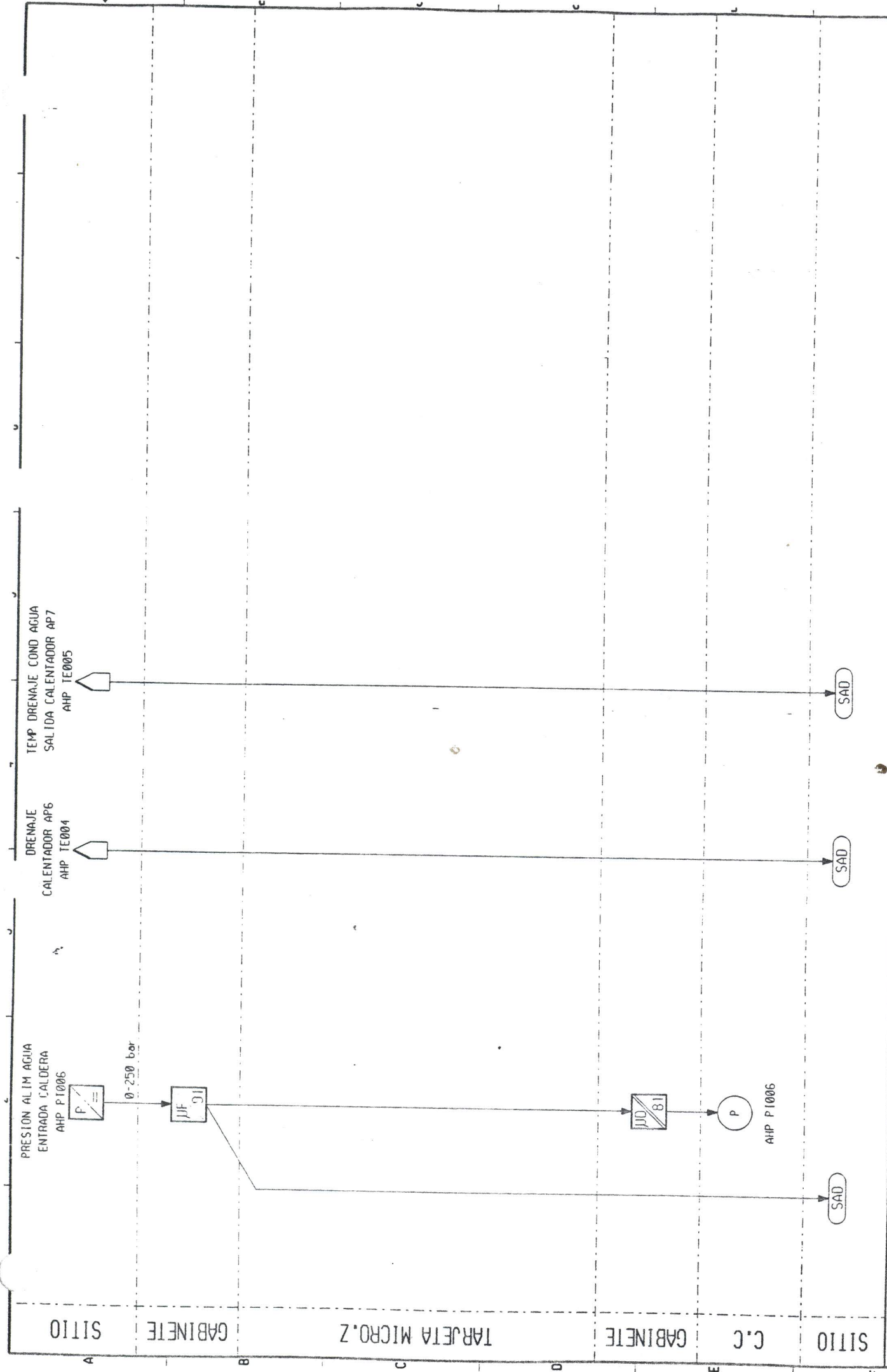

LAZO DE REGULACION: AHP 1 / 2 GABINETE: KR000 IAR TARJETA:		ALM34MF 530SR001		DIVISION ERE P
P2332 A30000 - B		CEGELEC		EQUIP 40
VOR 41		80 HUSLZL9079		41

Co document impresa de CEGELEC no debe ser otro utilizar, copie de contrapunto a dos filas sans son autorizacion.



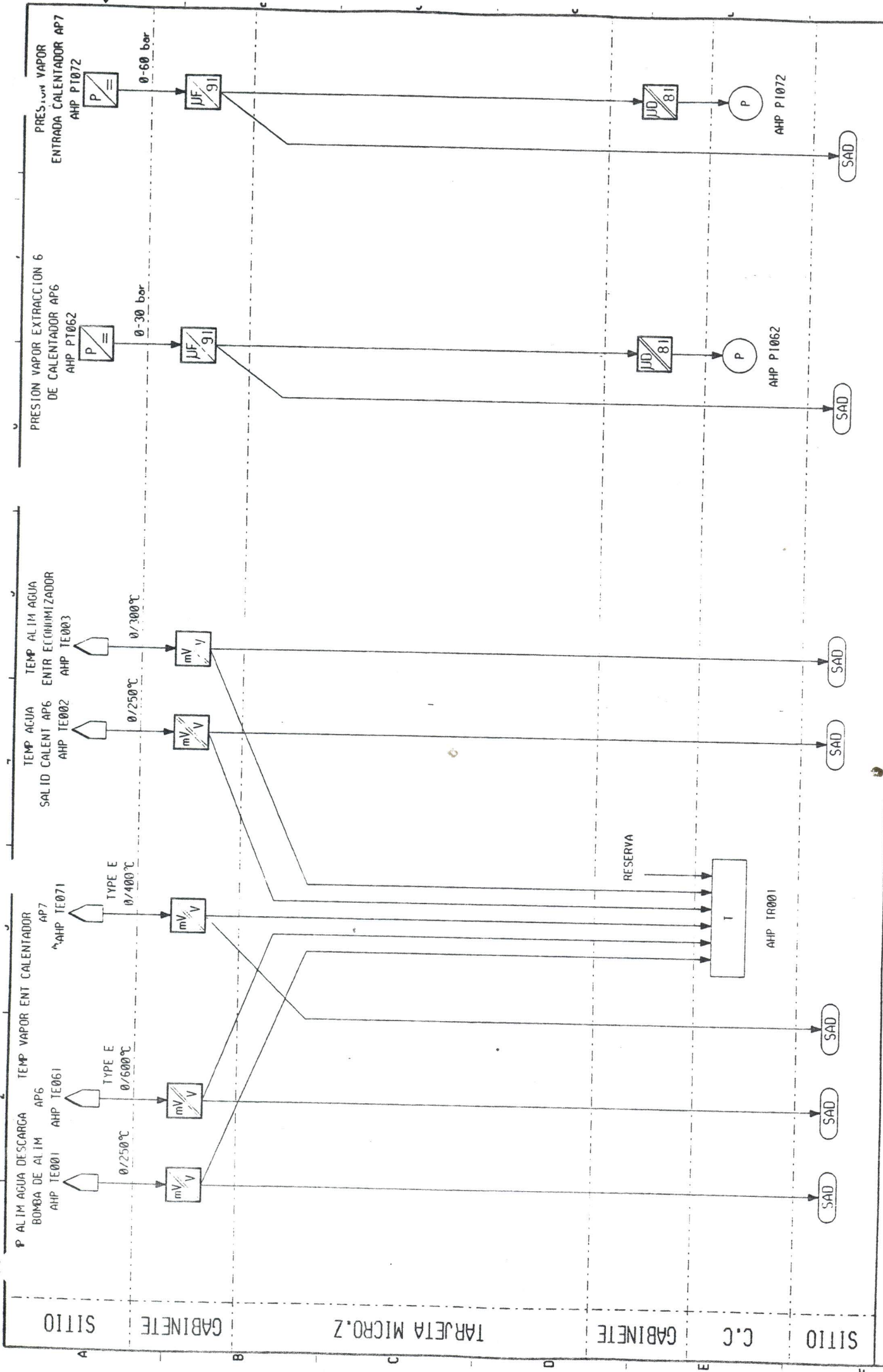

LAZO DE REGULACION: AHP 2 / 2  
 GABINETE: KRC001  
 TARJETA:

ALM34MF 530SR001

CEGELEC

P 2332 A30000 - B

Division: ERE P  
 COPIA: 41  
 SE: 43

RS/SL/90/95

Ce document appartient à CECELEC, ne doit pas être utilisé, copié ou communiqué à des tiers sans son autorisation.

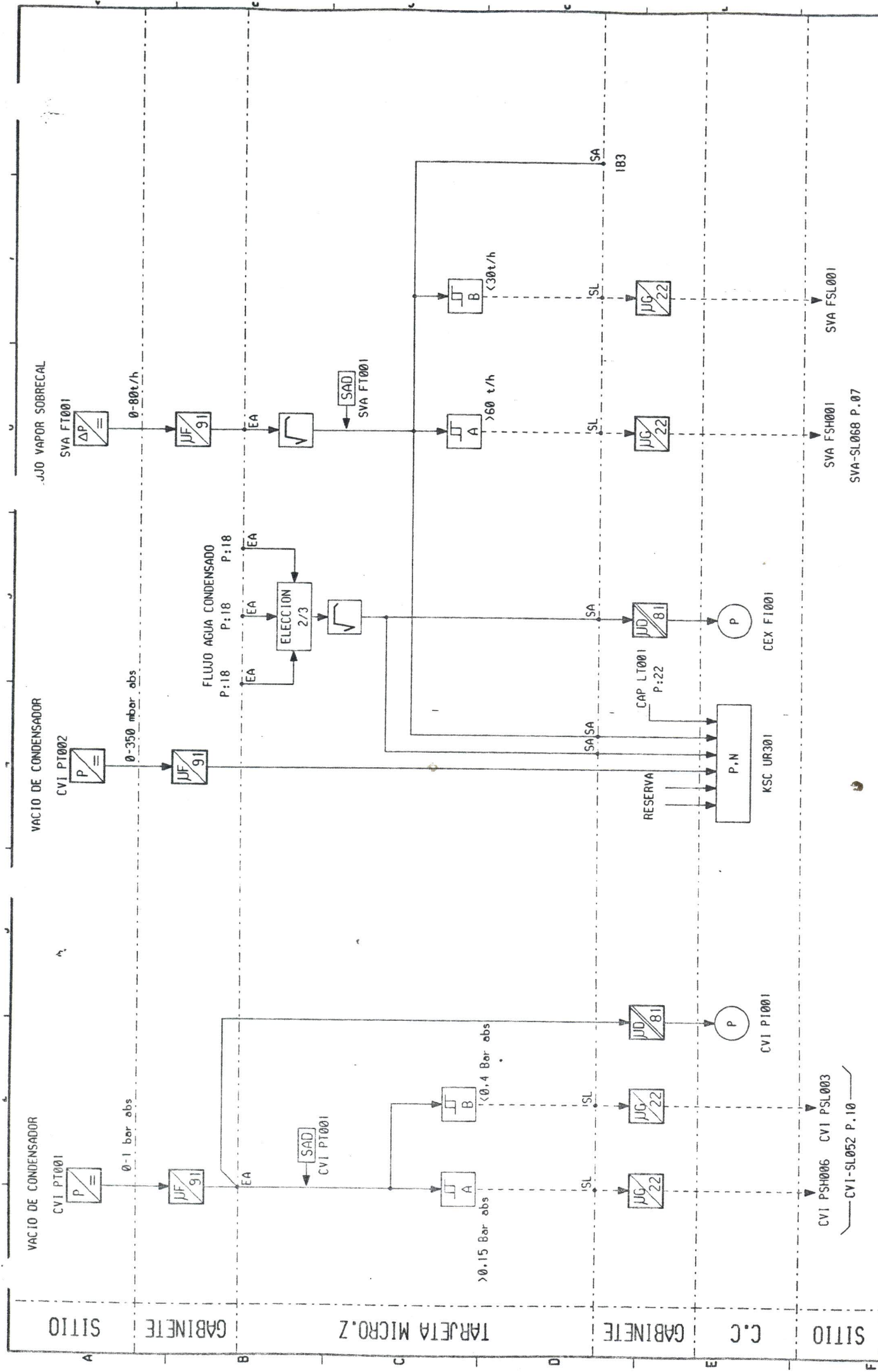

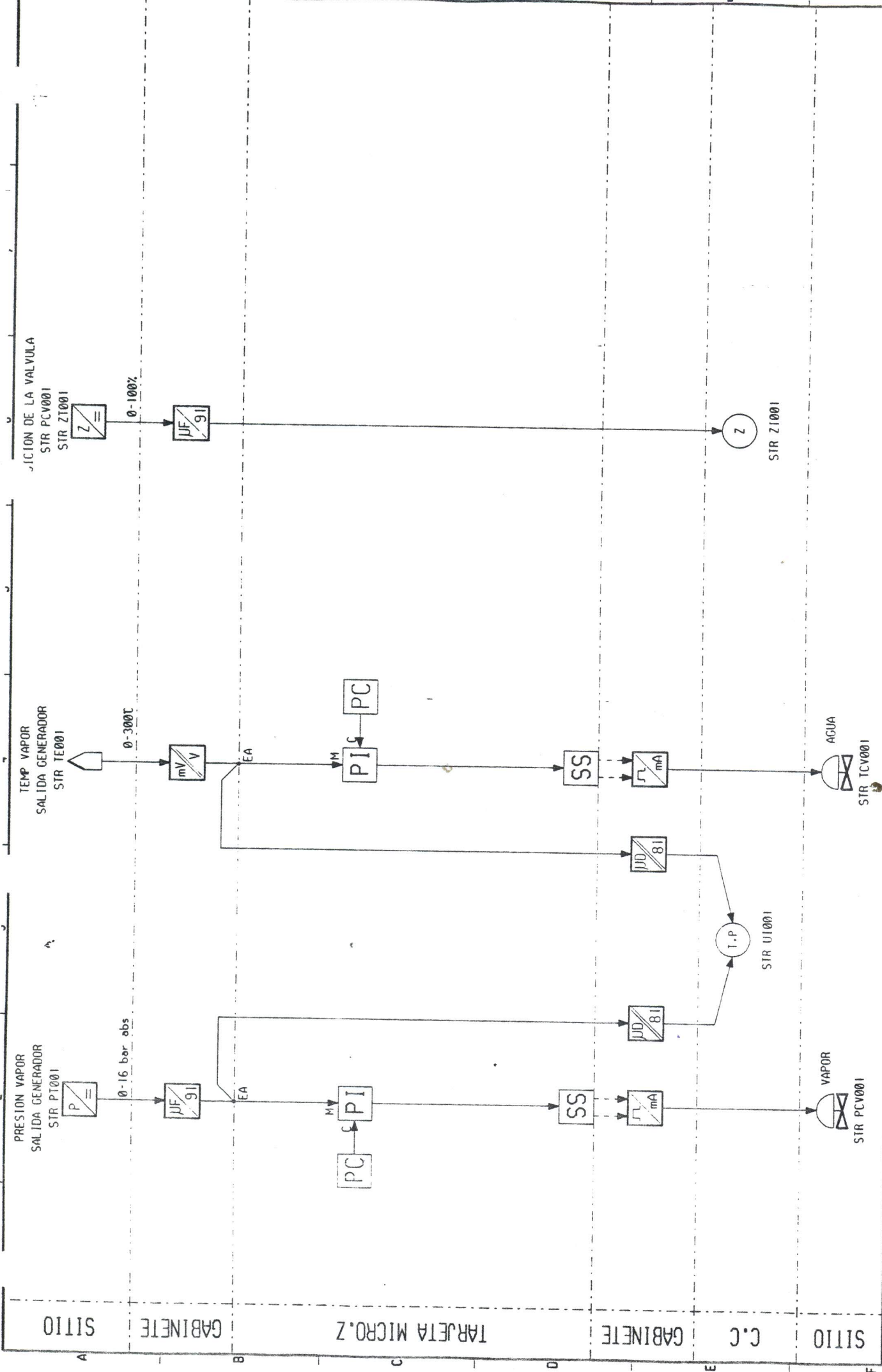



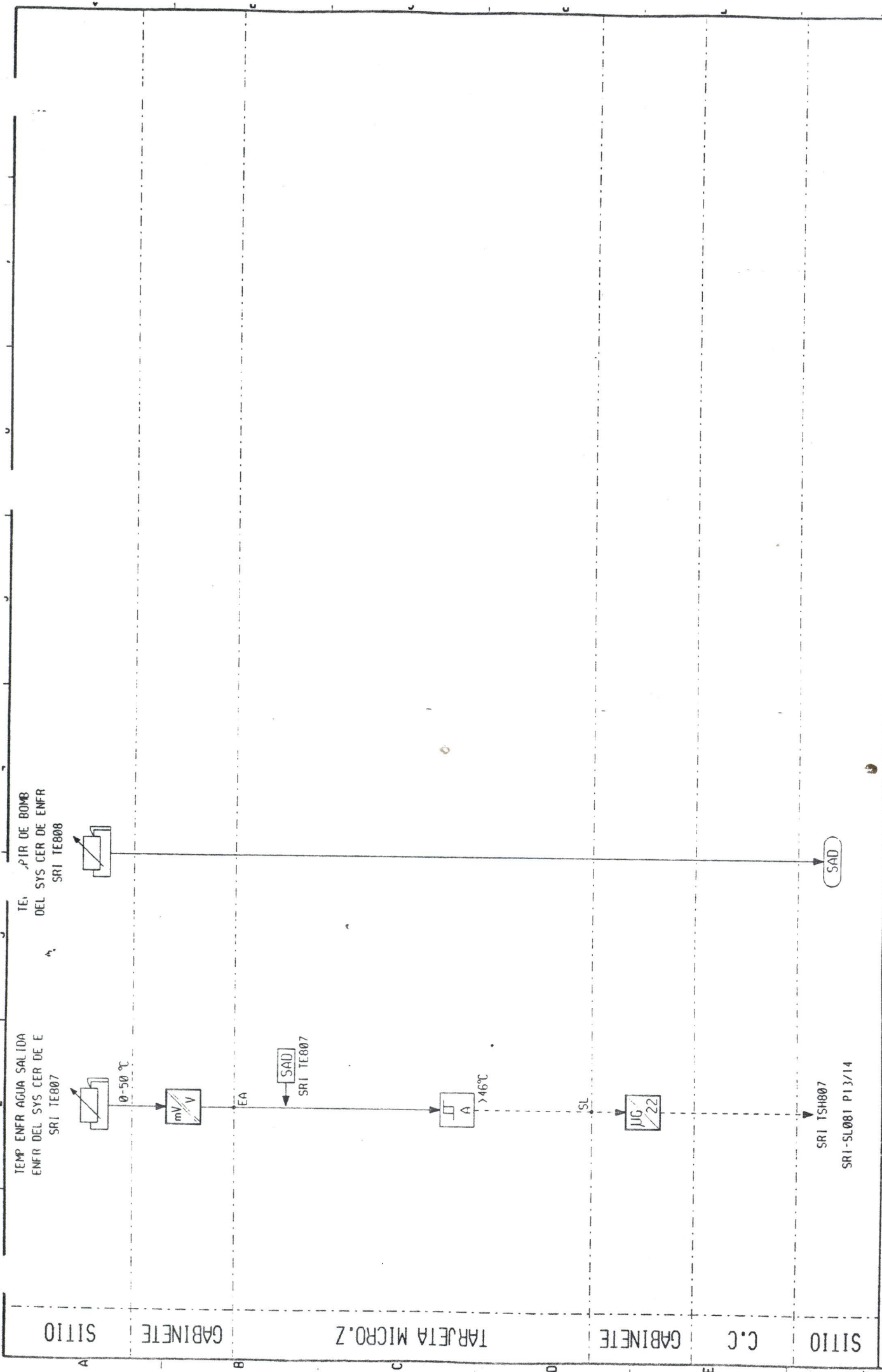

Division ERE P  
**CEGELEC**  
 P 2332 A30000 - C  
 EQUIPO 47  
 VOR 49  
 SRI

ALM34MF 530SR001

LAZO DE REGULACION: SRI 1 / 1  
 GABINETE: KFG001AR  
 TARJETA: 1B8

Este documento propiedad de CEGELEC no debe ser usado sin el consentimiento de sus representantes autorizados.

PRESSION AIRE INSTRUM  
 ENTRADA CASA DE MAQUINAS  
 SAR PT001

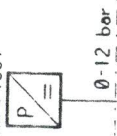

EA



<6 Bar



SAR P1001



SAR PSL001

S...SL088 P.05

SITIO

GABINETE

TARJETA MICRO.Z

GABINETE

C.C

SITIO

LAZO DE REGULACION: SAR 1 / 1  
 GABINETE: KR001AR  
 TARJETA: 188

ALM34MF 530SR001

P 2332 A30000 - C

Division  
 ERE P

VOYER  
 49 49 51

00 EUSLZ 3045

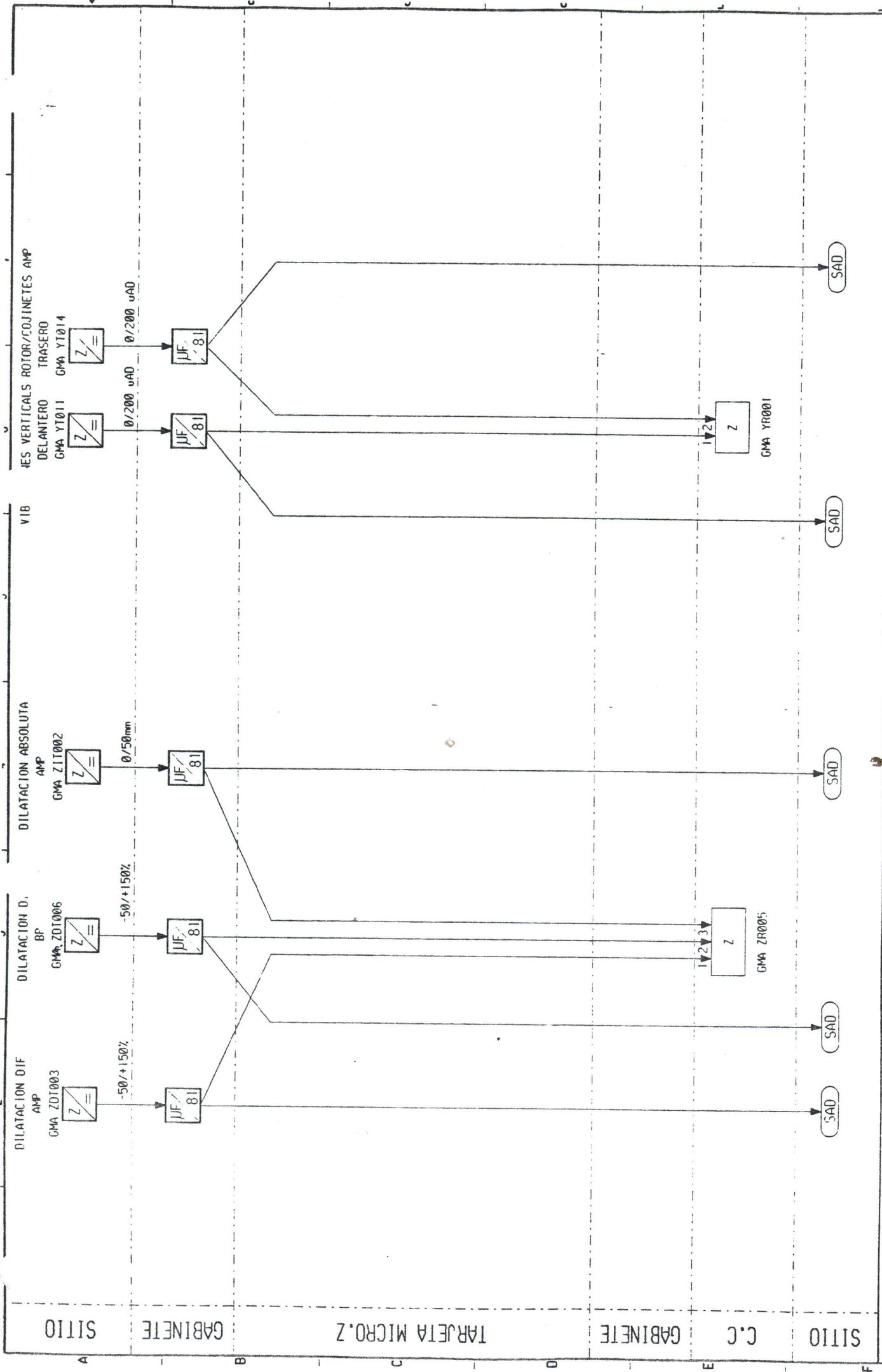

Lazo de Regulacion: GMA 1 / 5		Division: CEGELEC		Division: ERE P
Gabinete: KR0001AR		P 2332 A30000 - B		ERE P
Tarjeta:		ALM34MF 530SR001		REP
				REP
				51
				52
				REP
				REP

Os documentos de CEGELEC no son para uso externo, excepto en comunicaciones a otros usuarios autorizados.



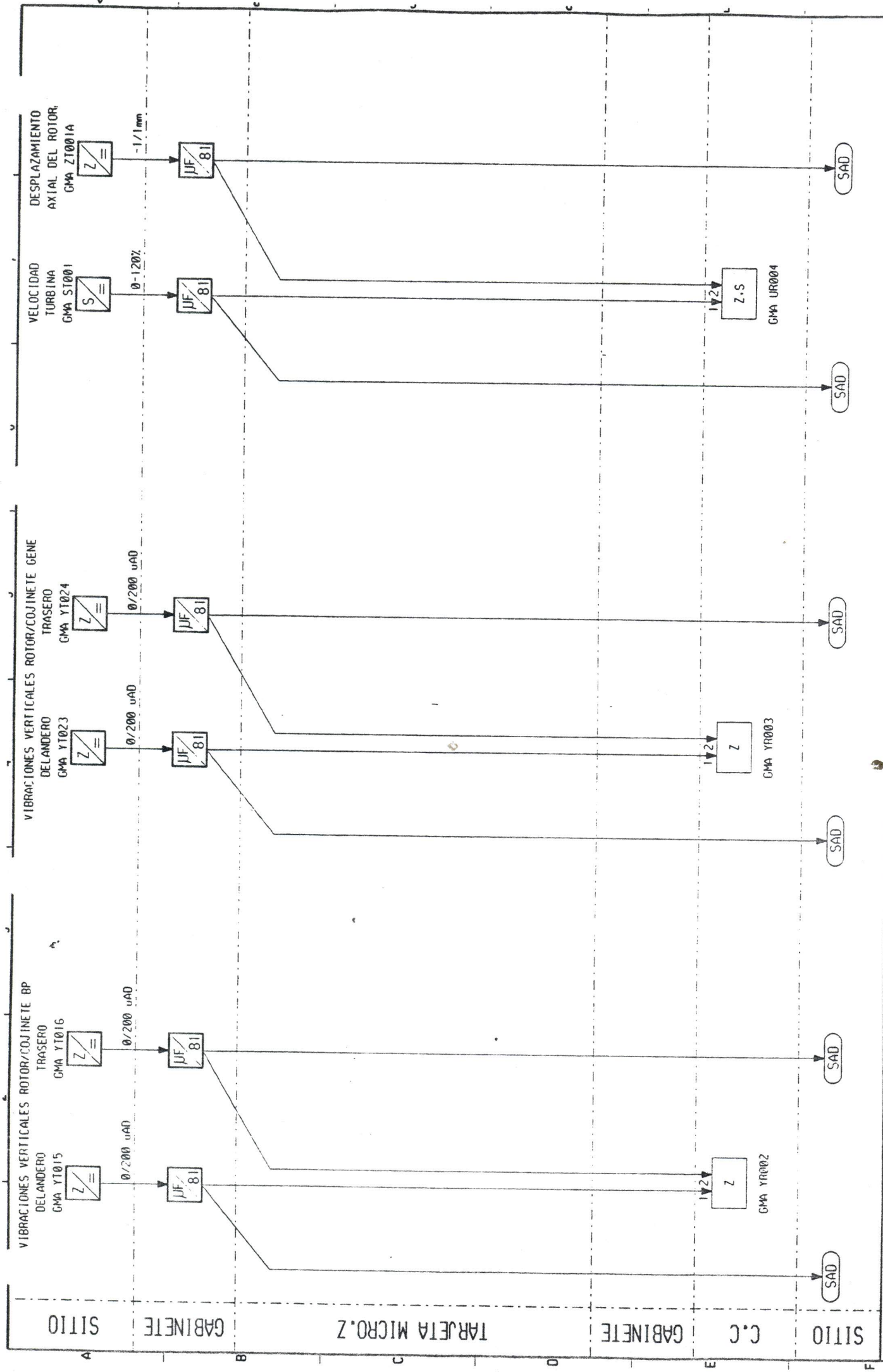

SITIO

GABINETE

TARJETA MICRO.Z

GABINETE

C.C

SITIO

TEMPERATURAS TURBINA

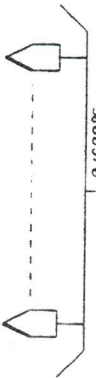

- GMA TE001
- GMA TE051
- GMA TE009
- GMA TE010
- GMA TE011
- GMA TE012
- GMA TE013
- GMA TE018
- GMA TE019
- GMA TE021
- GMA TE060

RESERVA



GMA TR001

TEMPERATURAS TURBINA

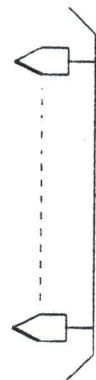

- GMA TE 062
- GMA TE 032
- GMA TE 031
- GMA TE 039
- GMA TE 040
- GMA TE 041
- GMA TE 044
- GMA TE 045
- GMA TE 046
- GMA TE 073
- GMA TE 082
- CET TE032



KSC TR401

LAZO DE REGULACION: GMA 3 /5

GABINETE:

TARJETA:

ALM34MF 530SR001

CEGELEC

P 2332 A30000 - B

Division  
ERE P

COPIA	53
SEÑAL	53
VOPR	54

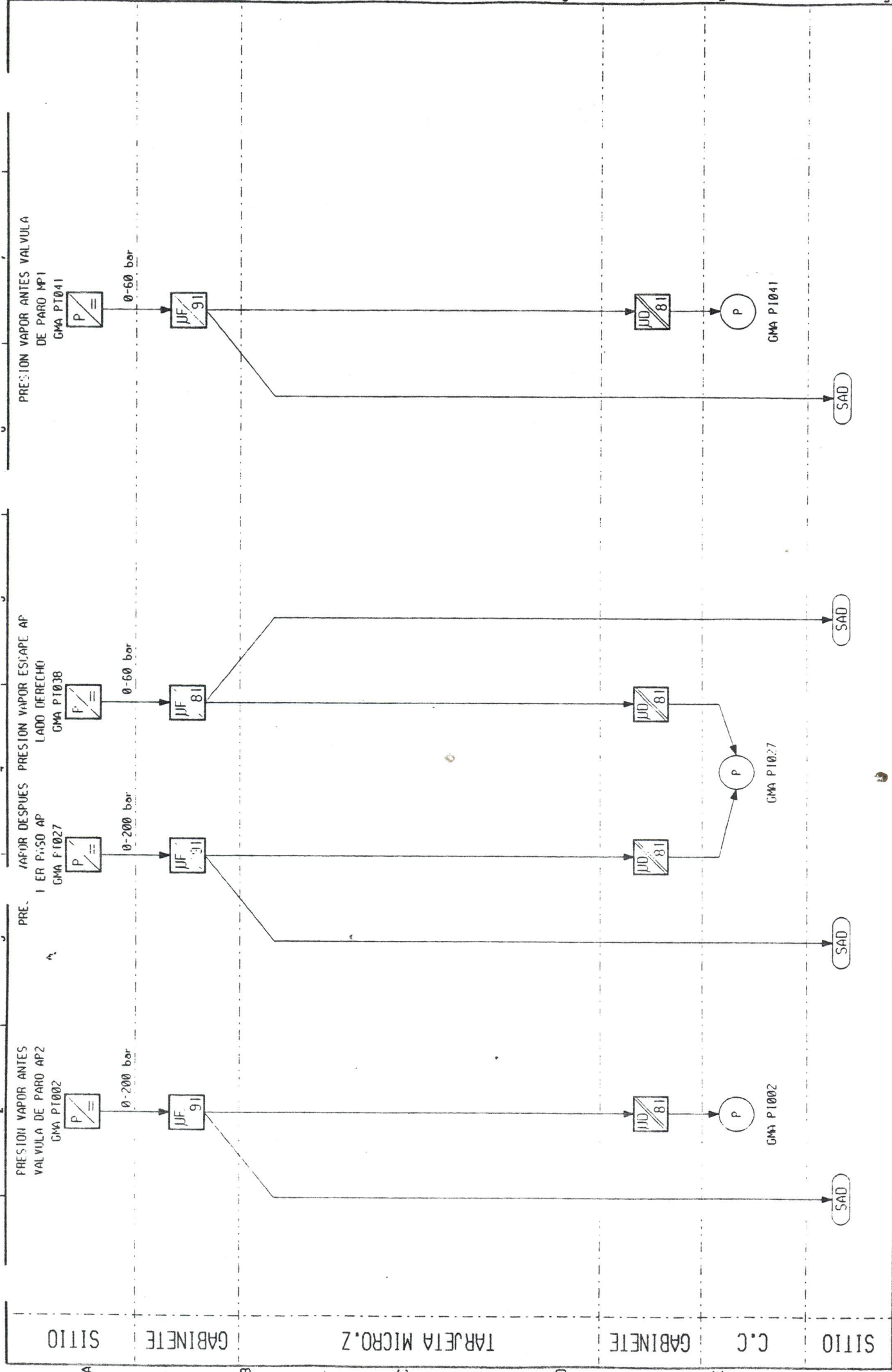

Lazo de Regulación: GMA 4 '5		Division: CEGELEC		Division: ERE P
Gabinete: KRG001AR		P 2332 A3000 - B		REP: 54
Tarjeta: A				55
		ALM34MF 530SR001		5015213045

On document propriété de CEGELEC ne doit pas être utilisé, copié ou communiqué à des tiers sans son autorisation.



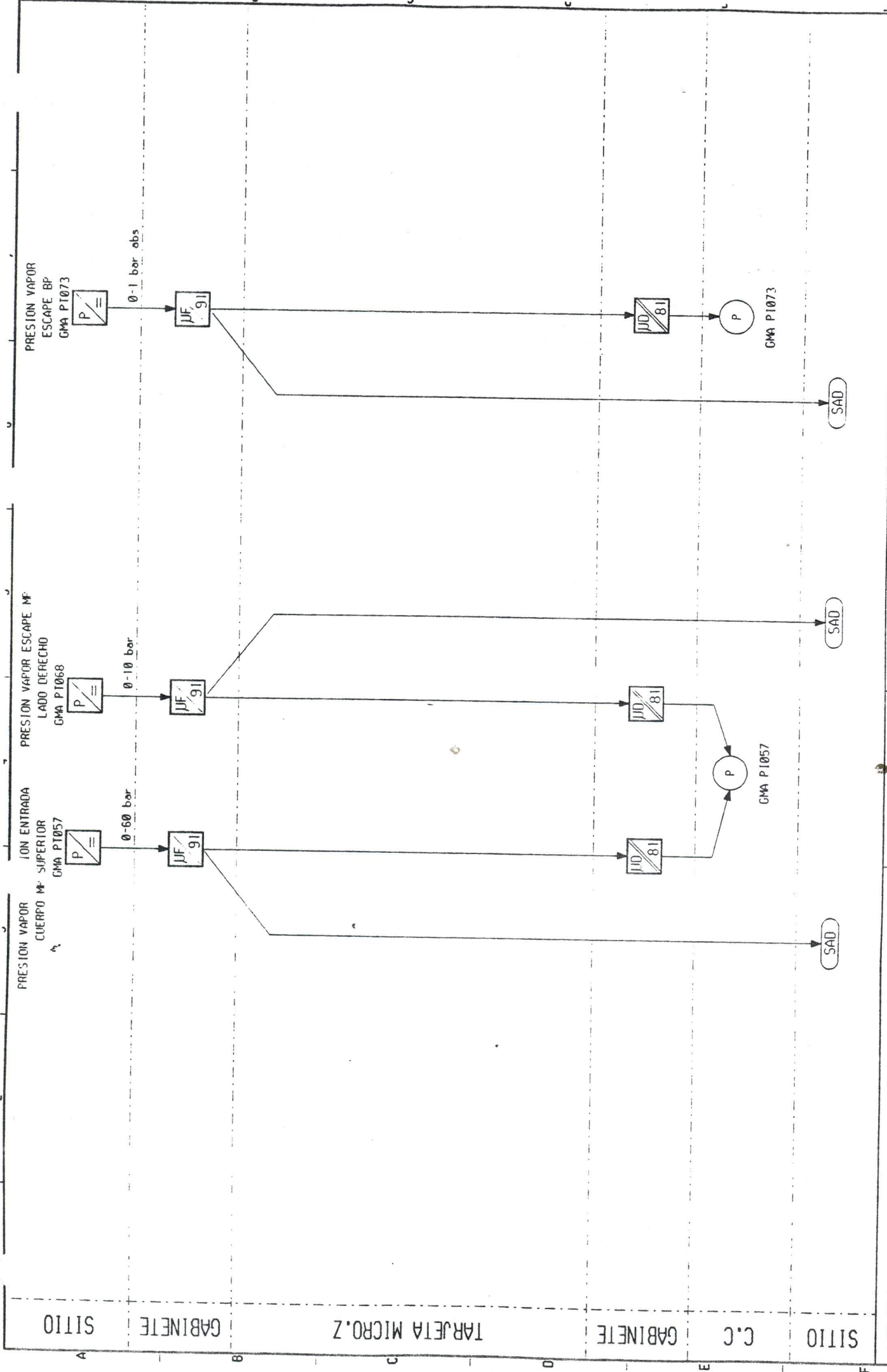

SITIO

GABINETE

TARJETA MICRO.Z

GABINETE

C.C

SITIO

LAZO DE REGULACION: GMA 5 /5  
 GABINETE: KRG001AR  
 TARJETA:

ALM34MF 5303R001

CEBELEC

P 2332 A30000 - B

Division  
 ERE P

LOG. P  
 55

V. H. F.  
 57

1057219042

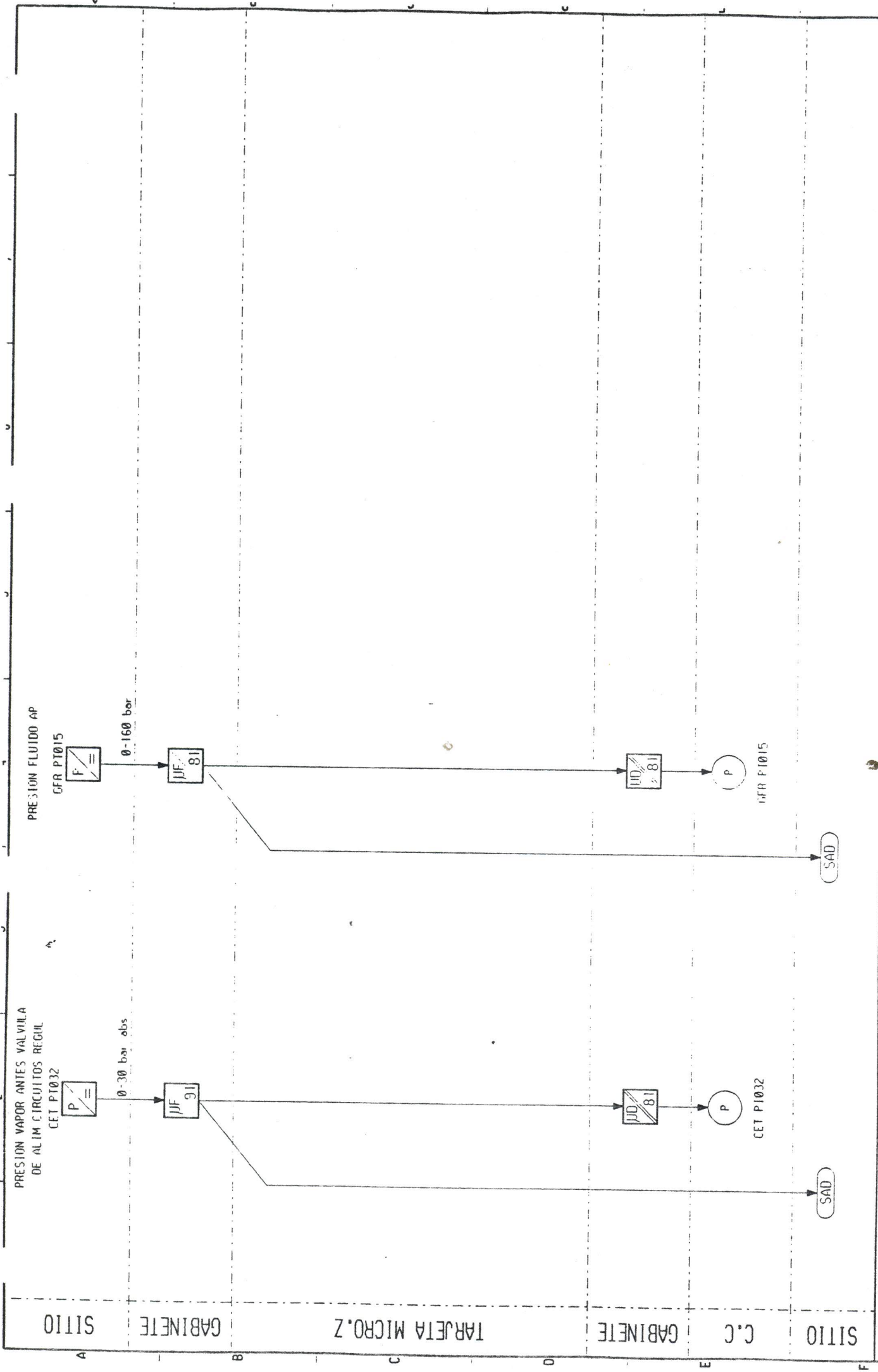

SITIO  
GABINETE  
TARJETA MICRO.Z  
GABINETE  
C.C  
SITIO

LAZO DE REGULACION: CET/GFR 1 / 1  
 GABINETE: KR0001AR  
 TARJETA:

ALM34NF 530SR001

CEGELEC

P 2332 A30000 - B

Division  
ERE P

57 59

RUSLZ 5749

Ce document est propriété de CEGELEC. Il est prêt à être utilisé, copié ou communiqué à des tiers sans son autorisation.

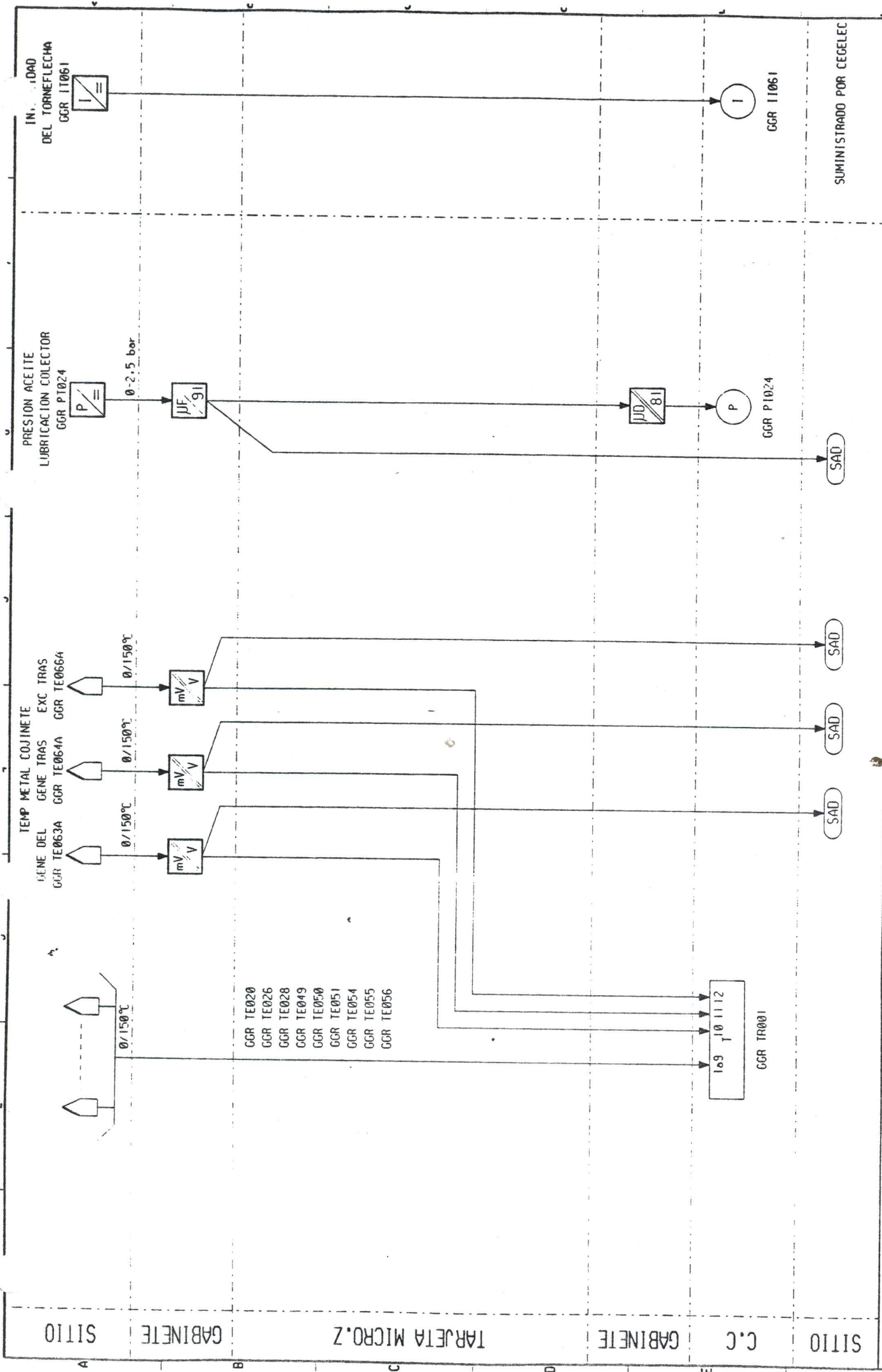

SITIO GABINETE TARJETA MICRO.Z GABINETE C.C. SITIO

SUMINISTRADO POR CEGELEC

ALM34MF 530SR001

LAZO DE REGULACION: GCR 1 / 1  
 GABINETE: KRG001AR  
 TARJETA:

P 2332 A30000 - C

Division	ERE P
FORM	59
FOR	61

CEGELEC

Da document propiedad de CEGELEC no doit pas etre utilise, copie ou communiqué a des tiers sans son autorisation.

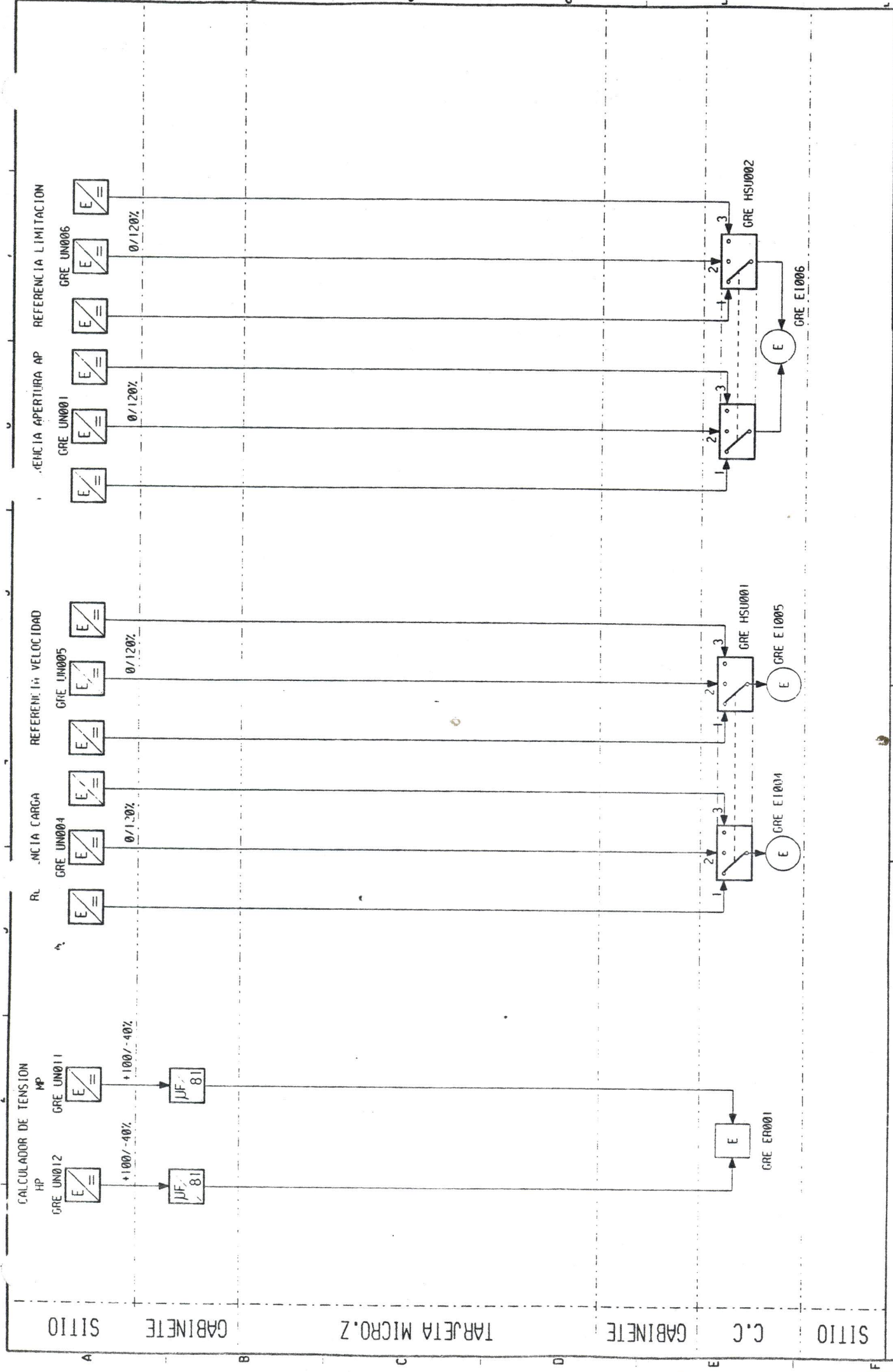

Division: ERE P  
 P 2332 A30000 - C  
 ALM341/F 5305R001  
 LAZO DE REGULACION: GRE 1 / 1  
 GABINETE: KRG001AR  
 TARJETA:  
 Co document propriété de GECELEC ne doit pas être utilisé, créé ou communiqué à des tiers sans son autorisation.



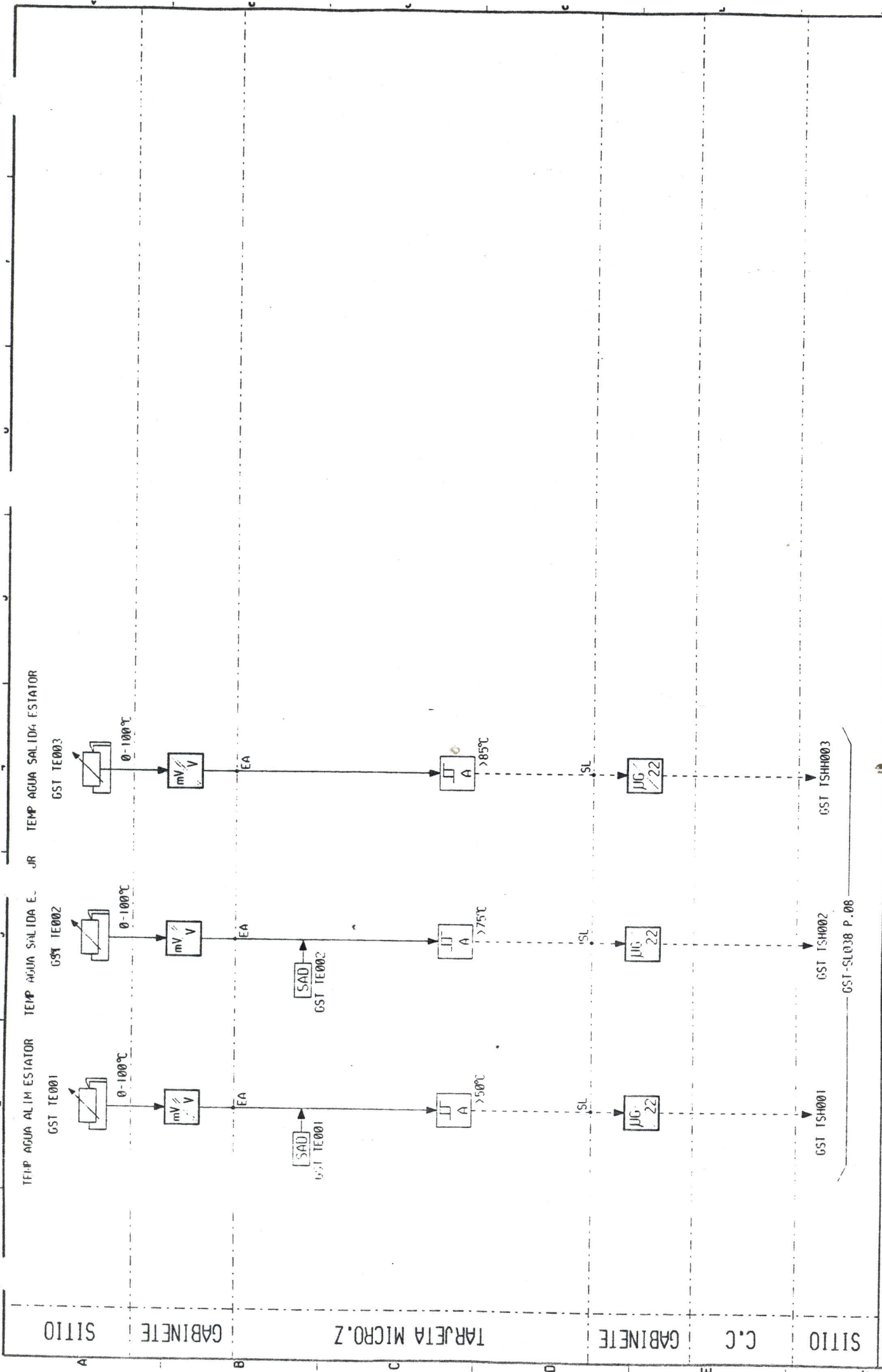

LAZO DE REGULACION: GST 1 / 2  
 GABINETE: KRG001AR  
 TARJETA: 1B8

ALM34NF 530SR001

Division: CEGELEC  
 ERE P  
 P 2332 A30000 - C

FORM	63	64
SERIE	63	64

CE DOCUMENT EST PROPRE DE CEGELEC NE DOIT PAS ETRE UTILISE, COPIE OU COMMUNIQUE A TROIS TERS SANS SON AUTEURISACION

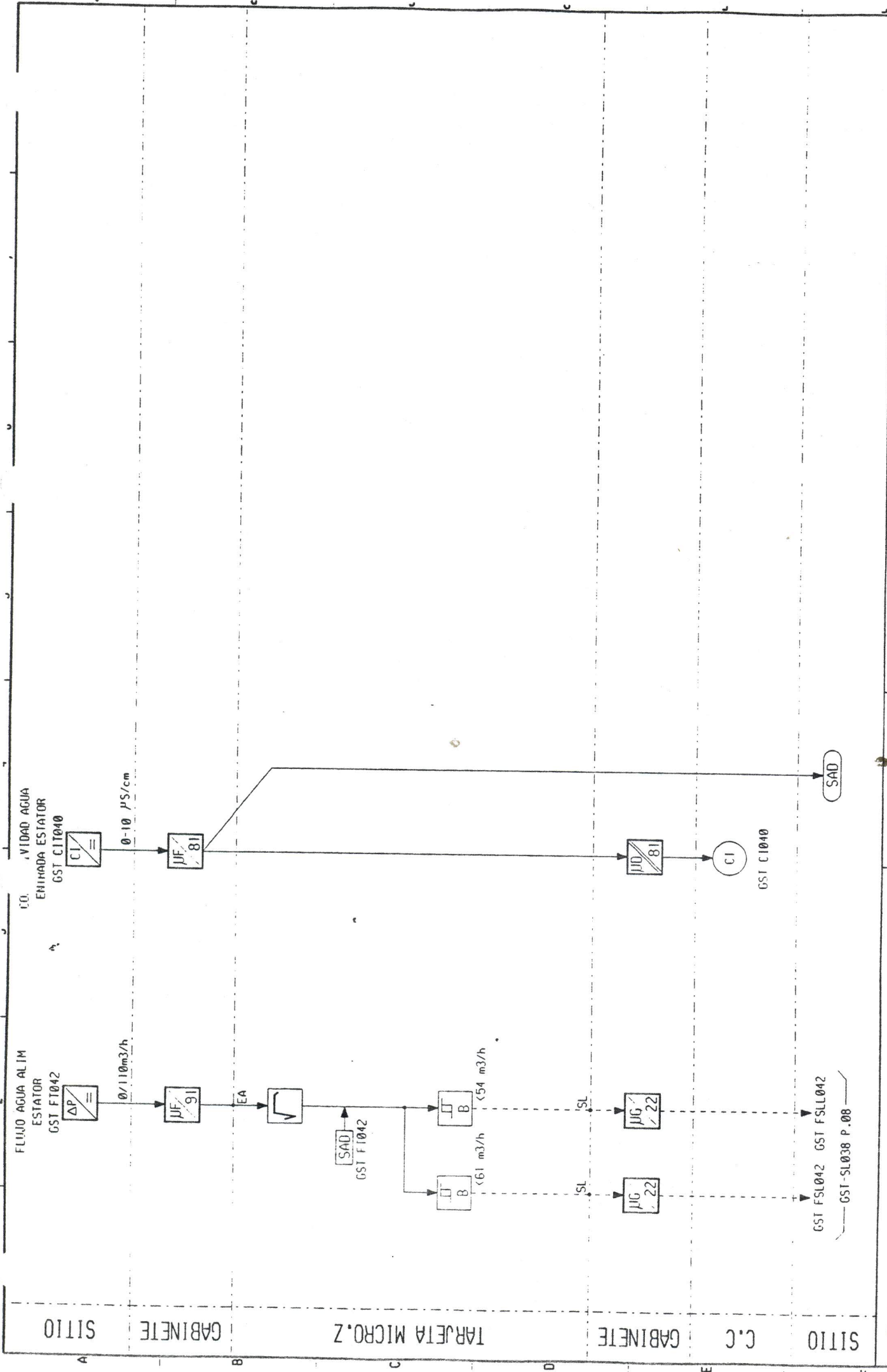

SITIO

GABINETE

TARJETA MICRO.Z

GABINETE

C.C

SITIO

LAZO DE REGULACION: GST 2 / 2  
 GABINETE: KR0001AR  
 TARJETA: 1E3

ALM34MF 530SR001

P 2332 A30000 - C

Division  
 ERE P  
 500P  
 5.1 5.1 5.1

Ce document propose de CEGELEC ne doit pas être utilisé, copié ou communiqué à des tiers sans son autorisation.

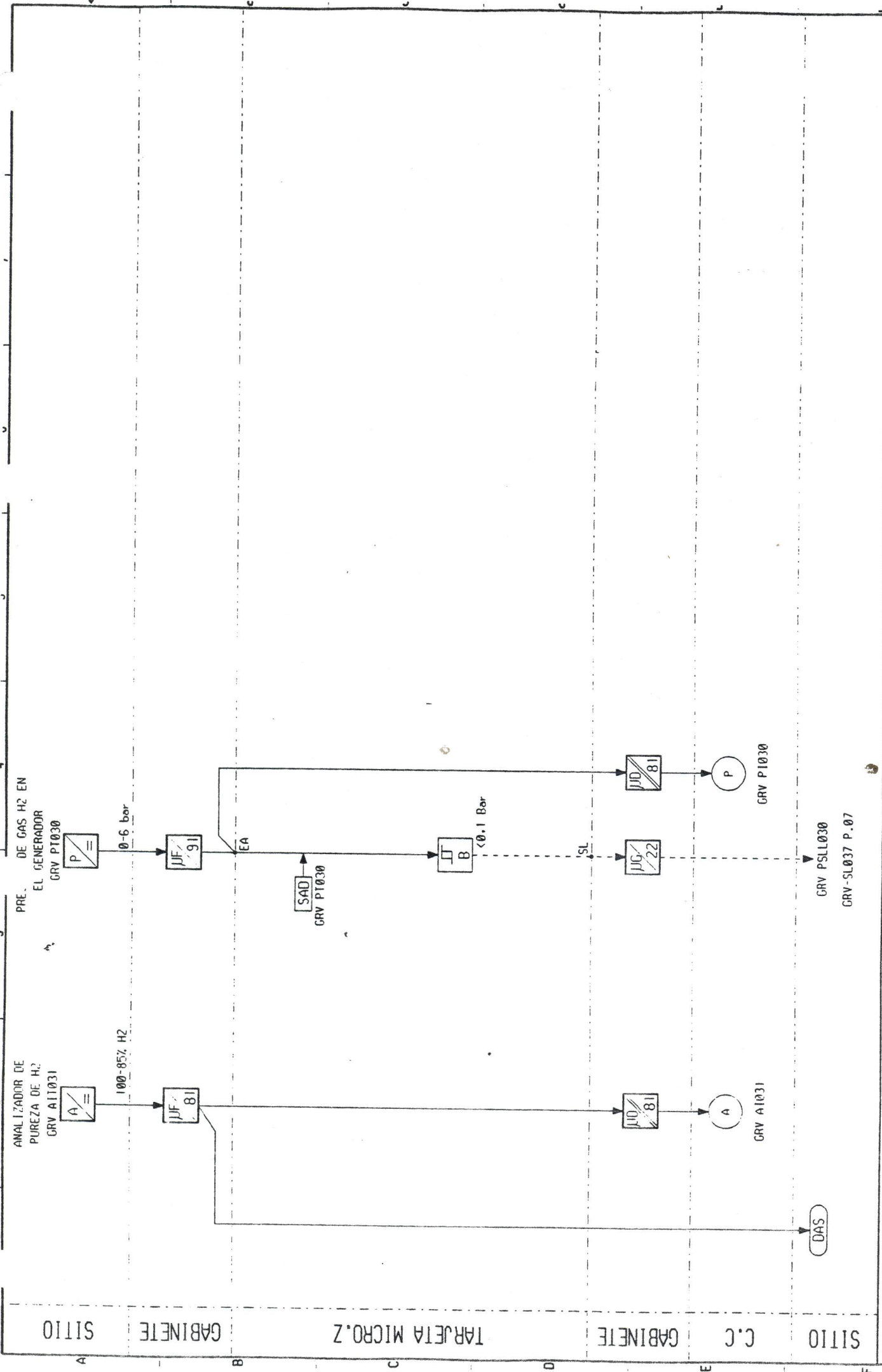

Division: CEGEEC  
 ERE P  
 P 2332 A30000 - C  
 ALM34MF 530SR001  
 LAZO DE REGULACION: GRV 1 / 2  
 GABINETE: KRC001AR  
 TARJETA: 1B8  
 De document propriété de CEGEEC ne doit pas être utilisé, copié ou communiqué à des tiers sans son autorisation.  
 66 68 68  
 RUSL2190

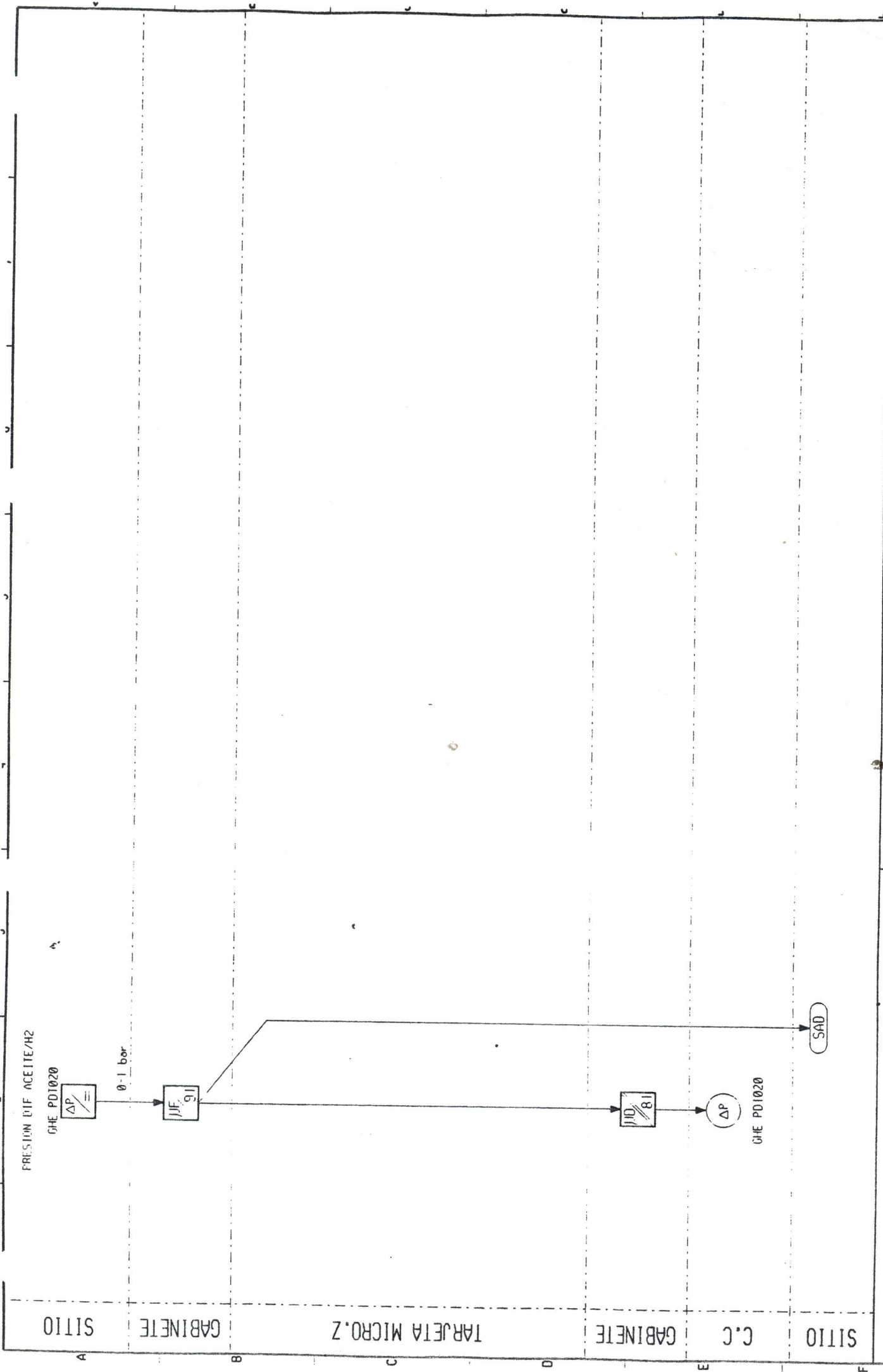

PRESSION DIF ACETTE/H2

GHE PDT020

0-1 bar

JJE 911

JJD 811

GHE PDT020

SAD

SITIO

GABINETE

TARJETA MICRO.Z

GABINETE

C.C

SITIO

LAZO DE REGULACION: GHE 1 / 1

GABINETE: KRC001AH

TARJETA:

ALM34MF 530SR001

CEGELEC

P 2332 A30000 - C

Division  
ERE P  
COPIA  
SEP 68  
VOP  
XP 69



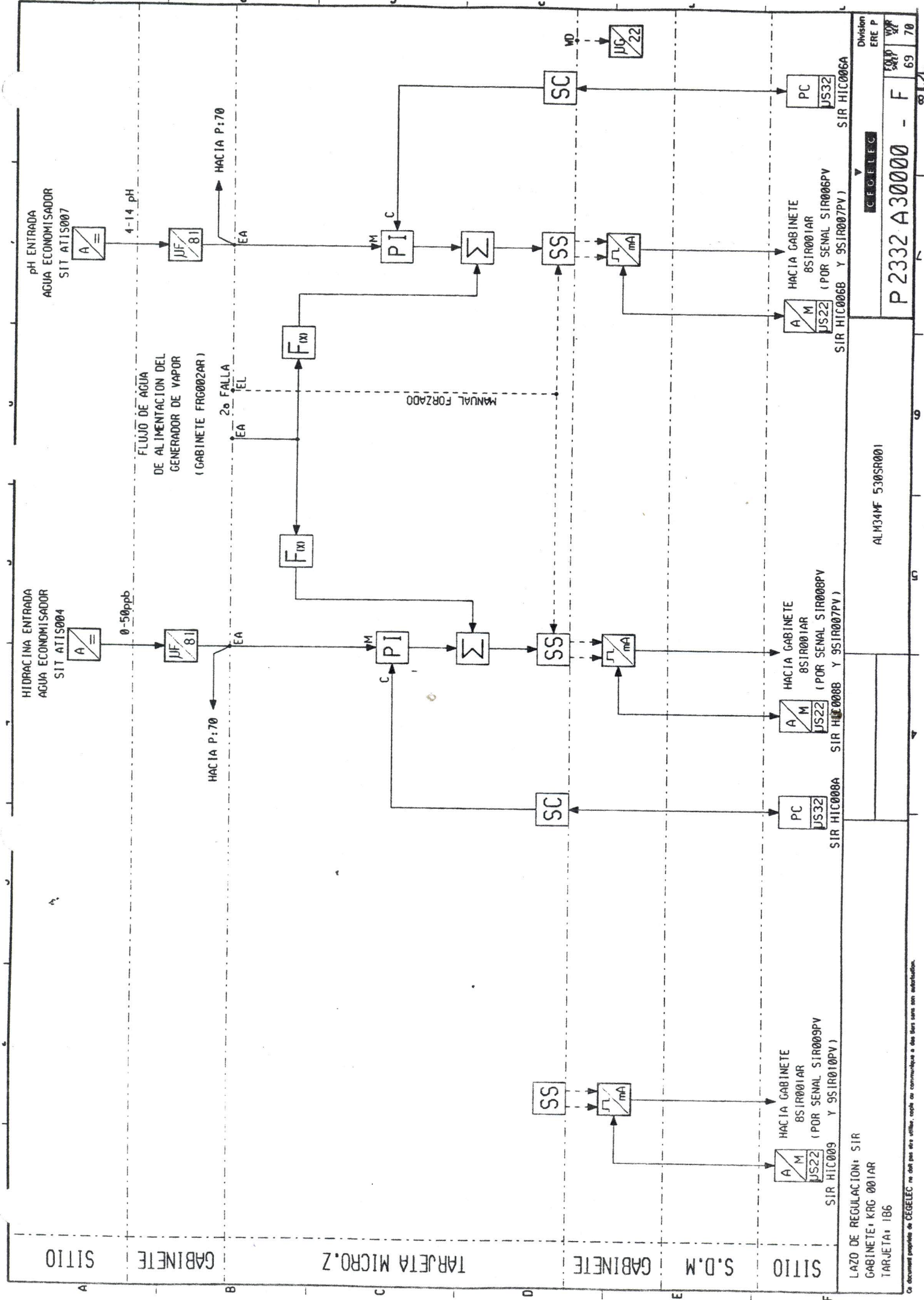

SITIO

GABINETE

TARJETA MICRO.Z

GABINETE

S.D.M

SITIO

LAZO DE REGULACION: SIR  
 GABINETE: KRG 001AR  
 TARJETA: 1B6

HACIA GABINETE  
 8SIR001AR  
 JS22 (POR SENAL SIR009PV  
 Y 9SIR010PV)  
 SIR HIC009

HACIA GABINETE  
 8SIR001AR  
 JS22 (POR SENAL SIR008PV  
 Y 9SIR007PV)  
 SIR HIC008A

HACIA GABINETE  
 8SIR001AR  
 JS22 (POR SENAL SIR006PV  
 Y 9SIR007PV)  
 SIR HIC006B

PC  
 JS32  
 SIR HIC006A

ALM34NF 530SR001

CEGELEC

Division  
 ERE P

P2332 A30000 - F

69 70

Ce document propriété de CEGELEC ne doit pas être utilisé, copié ou communiqué à des tiers sans son autorisation.

SITIO

GABINETE

TARJETA MICRO.Z

GABINETE

C.C

SITIO

LAZO DE REGULACION: SIT 1 / 2  
GABINETE:  
TARJETA:

ALM34MF 530SR001

CEGELEC

Division  
ERE P

P 2332 A30000 - D

FORMA  
5427

VOR  
70 71

De document prepare de CEGELEC ne doit pas être utilis, copié ou communiqué a des tiers sans son autorisation.

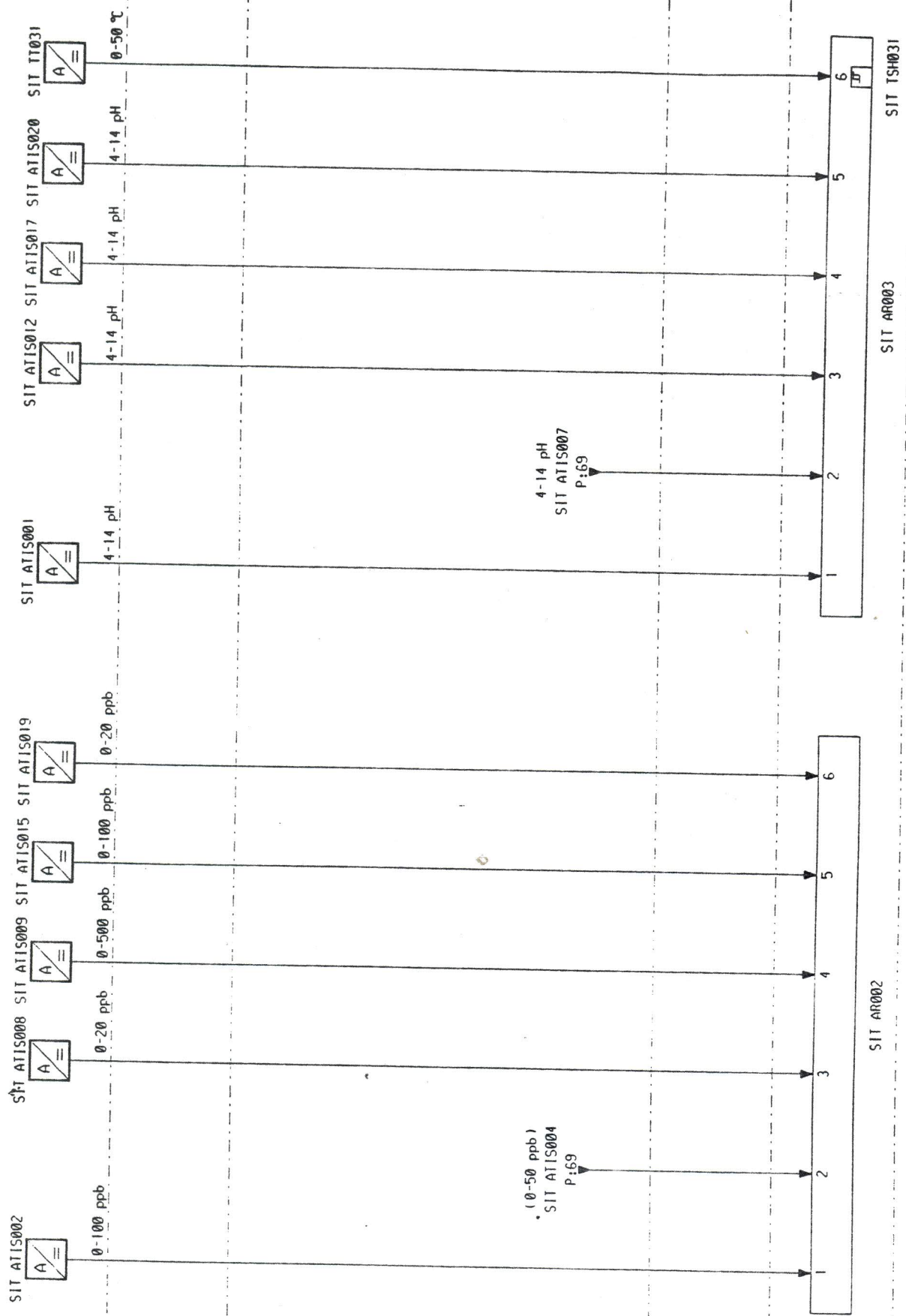

SIT ATIS002

SIT ATIS008

SIT ATIS009

SIT ATIS015

SIT ATIS019

SIT ATIS001

SIT ATIS012

SIT ATIS017

SIT ATIS020

SIT ATIS031

(0-50 ppb)  
SIT ATIS004  
Pt:69

4-14 pH  
SIT ATIS007  
Pt:69

SIT AR002

SIT AR003

SIT TSH031

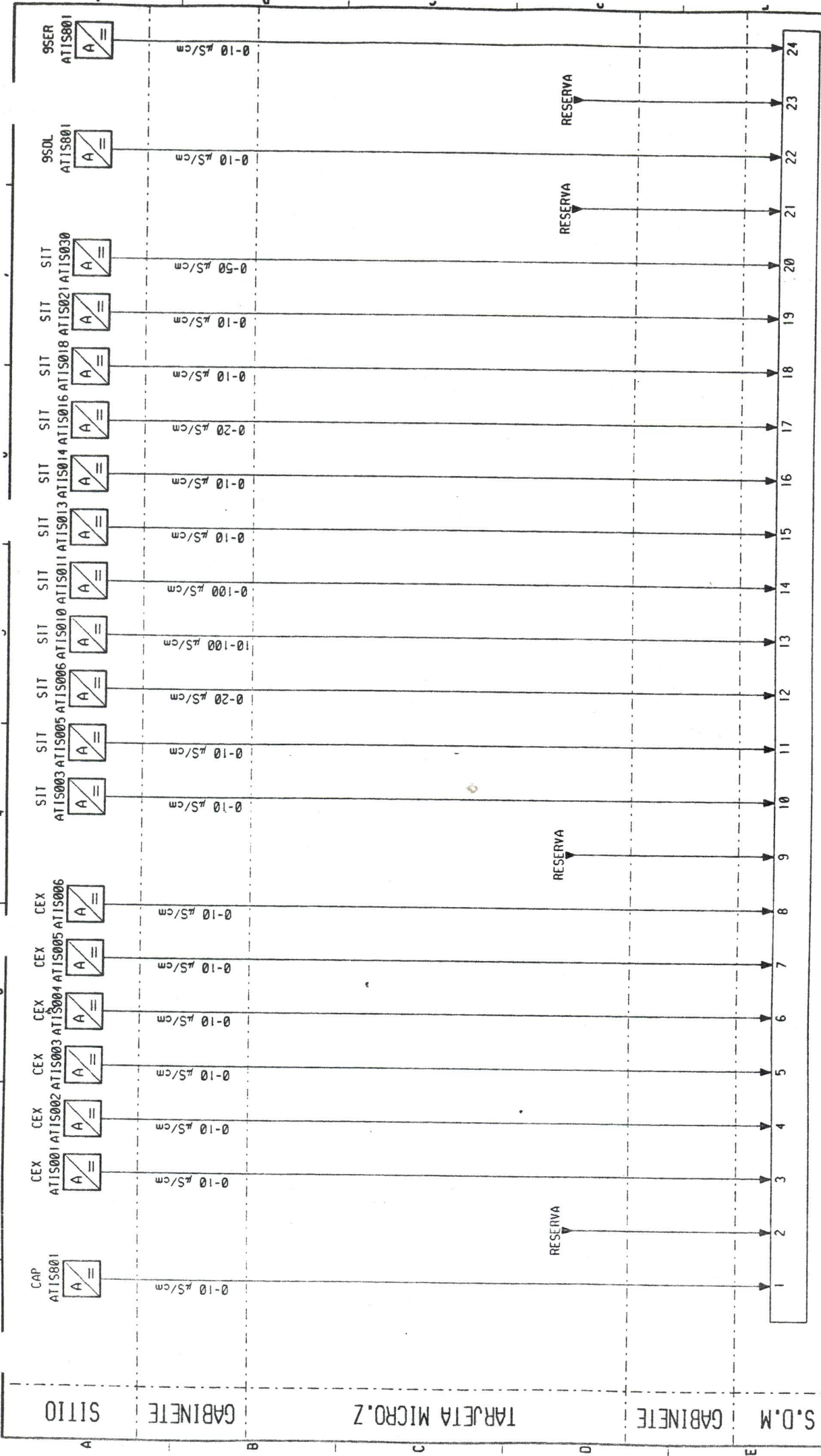

SIT AR001

SITIO

GABINETE

TARJETA MICRO.Z

GABINETE

S.D.M

SITIO

LAZO DE REGULACION: SIT 2 / 2

GABINETE  
TARJETA

ALM34MF 530SR001

CEGELEC

P 2332 A30000 - D

Division  
ERE P  
SITIO  
SITIO  
SITIO

71  
72



SRA 802 PO (UNIDAD 03)

SRA 801 PO (UNIDADES 03 Y 04)

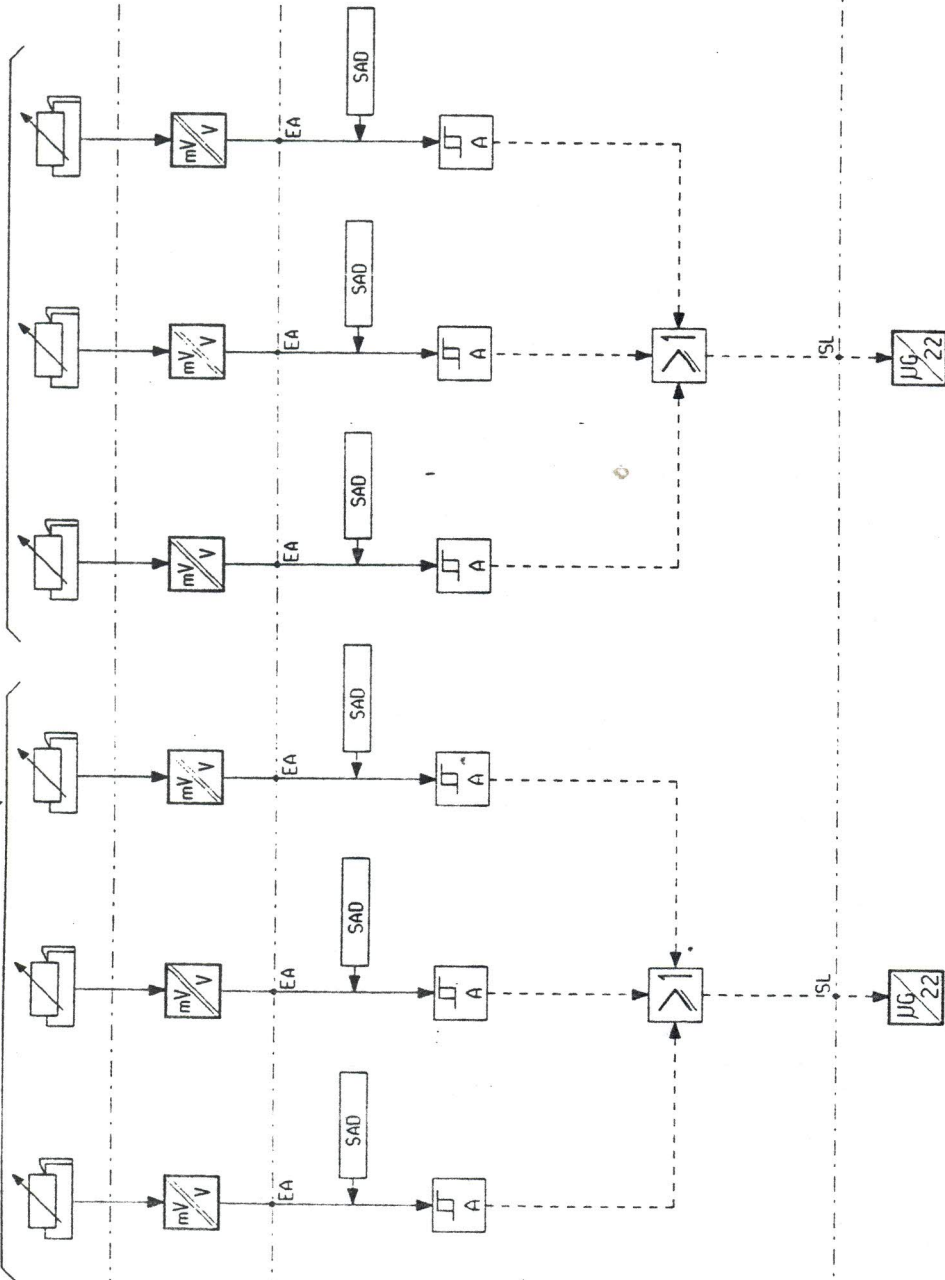

SITIO

GABINETE

TARJETA MICRO.Z

GABINETE

S.D.M

SITIO

LAZO DE REGULACION: SRA 1/1  
 GABINETE: KRG001AR  
 TARJETA: 186

ALM34MF 530SR001

CEGELEC

P2332 A30000 - F

Division ERE P  
 5019 VOP  
 72 /