



# Universidad Nacional Autónoma de México

## Facultad de Ingeniería

### Energy Loss Analysis of the Inter-Area Mode Using TV-OMIB Equivalent

**T E S I S**

QUE PARA OBTENER EL GRADO DE  
MAESTRO EN INGENIERIA ELECTRICA  
P R E S E N T A  
JAVIER DE JESUS GARCIA GUZMAN



DIRECTOR: DR. CARLOS JUAREZ TOLEDO  
REVISORES: DR. CLAUDIO RUBEN FUERTE ESQUIVEL  
M. I. RODOLFO LORENZO BAUTISTA  
DR. GERARDO RENE ESPINOSA PEREZ  
DR. PAUL ROLANDO MAYA ORTIZ

MEXICO, D. F.

MAYO 2011

**Energy Loss Analysis of the  
Inter-Area Mode Using TV-OMIB  
Equivalent**

**TESIS DE MAESTRIA EN INGENIERIA  
ELECTRICA**

**POR**

**JAVIER DE JESÚS GARCÍA GUZMÁN  
INGENIERO ELÉCTRICO- ELECTRÓNICO  
UNIVERSIDAD NACIONAL AUTONOMA DE  
MÉXICO**

**DIRECTOR DE TESIS**

**DR. CARLOS JUÁREZ TOLEDO**

## Agradecimientos

Antes que todo, agradezco a Dios por permitir que éste y otros sueños se hayan vuelto realidad y que también se sigan realizando; por darme fuerza, determinación, aguante y también por llenar mi camino con tanta gente importante para mí, tanto aquellos con quienes me he llevado bien como con aquellos que no me toleran. Sin duda alguna, mi vida no sería la misma sin alguna de esas personas pues todos han formado la persona que soy.

Siempre será difícil escribir una sección de agradecimientos porque hay tantas personas a quienes mencionar y tan poco espacio para ello. Sin embargo, creo fervientemente que hay personas que siempre son constantes en presencia y aquellas que siempre están conmigo en alma. Agradeceré, por tanto, a las personas que se vieron mayormente involucradas en el período de vida en que se realizó ésta tesis.

A mis padres, hermanas, abuelos, tíos y primos. Gracias a todos ustedes por su enorme apoyo, comprensión, soporte y alegría. Mamá, gracias por haberme dado vida, por amarme y apoyarme; sin tu enorme cariño no sería el hombre que soy. Papá, gracias por tu confianza, por tu apoyo y orgullo; son una motivación constante para que yo siga adelante. Miri y Adriana, son mis dos más bellos ángeles; sepan que nada les hará falta mientras yo tenga vida. A mi abuelita Adriana, por ser todos mis cimientos, por ser siempre la presencia más grande en mi vida, por darme la fuerza diaria que llena mi cuerpo. A mi tías Adriana y Elvia, ustedes son más mis madres que mis tías; les debo mi criterio y determinación para realizar mis sueños. Alan, Alfredo, Dulce, Emmanuel, Luis Mi, Mariana, Julieta, gracias por ser mi alegría y mi paz. De no ser por ustedes, la cordura hubiese desaparecido, el aguante hubiese sido aplastado y el trabajo mucho más pesado. Gracias por darme un poco de todos ustedes para tomar fuerza y seguir adelante. Éste trabajo así como todo aquello que haga está dedicado a ustedes.

Gracias a mis hermanos y hermanas escogidos, aquellos con quienes he compartido estudios, penas, alegrías y trabajo. A ti, Caro, por ser una de las partes más importantes de mi vida, por levantarme y estar ahí sin importar las circunstancias. Rosa, hija, aunque la distancia y los tiempos nos separen, sabes que eres mi tercera hermana, siempre tengo un espacio para ti en cada uno de mis días. Jorge, por ser el hermano, el amigo, desahogo en esas tardes de juego y mente en blanco que ya pocas veces me doy el lujo de tener. Carlos, FTC (tú sabes que significa); hermano, sabes que tienes mi apoyo para lo que necesites. Mariana, mi consuelo, mi cordura en momentos de locura; te debo tanto por hacerme ver la persona que soy y la persona que puedo llegar a ser, a pesar de las piedras en los diferentes caminos que debo recorrer. A Dial Monda, por ser mi realidad más virtual. Gracias a todos ustedes. A todos los demás, ustedes saben que tienen un espacio constante en mi corazón y que no me olvido de ninguno de ustedes.

Por último, pero no menos importante, agradezco a mis profesores por ser los cimientos de mi formación y por su entusiasmo en la enseñanza de la ingeniería. Quiero agradecer especialmente a:

Ing. Gabriel Jaramillo, su apoyo, enseñanza y alegría fueron el factor determinante de mi estancia en la Facultad de Ingeniería. Mis respetos y más sincero agradecimiento son para usted.

Ing. Rafael Guerrero, no tengo palabras para poder agradecer debidamente haber tenido el honor y la fortuna de aprender la ingeniería de sus manos. Sus consejos, amabilidad, estimación y apoyo constantes forjaron el inicio de mi carrera profesional. Por usted sé el ingeniero que quiero llegar a ser.

Ing. Santiago Barcón, gracias por la confianza en un servidor y el apoyo brindado para finalizar estos estudios.

Finalmente a:

Dr. Carlos Juárez, gracias por hacer posible este trabajo, por su incondicional apoyo y confianza. Usted es uno más de mis ejemplos a seguir así como también un gran amigo para mí. Gracias por todo.

*"Vive como si mañana fueras a morir y aprende como si fueras a vivir para siempre."*

*Mahatma Gandhi*

## Prologue

This work is meant to be an introduction text for power systems study, analysis and control. The presented theory is based on concepts of energy; more specifically, a generalized method is proposed over a four machine IEEE model.

The appearance of the OMIB (One Machine Infinite Bus) method has given a starting point to the development of more efficient methods to determine power system stability, creating a whole family of methods. Most of them are focused on system stability and only a few propose a method to analyze the power system nonlinearities; this work is among the last ones.

Some ideas to determine power system energy losses are presented and some original ideas to analyze and include inherent nonlinear terms of the system are treated as well, including a way to analyze such losses through nonlinear methods and spectral analysis.

The reader must be familiar with electromechanical concepts, nonlinear methods applied on power systems and spectral analysis for a better comprehension of this work.

The fulfillment of this work is a motivation and pride for me. I hope this thesis will be useful for you as it was for me.

## Abstract

In this dissertation a new advancement in the development of time-varying multi-area representations of large-scale complex systems is presented. The new approach combines Energy Loss Analysis and Time Varying One-Machine Infinite Bus Dynamic Equivalent, and can be used to determine critical loading conditions, and assess multi-swing instability and control.

Inspired by the idea of Energy losing in pattern recognition, on-line Dynamic Equivalent for transient stability assessment and control of stressed power systems involving complex inter-area oscillations are developed. New conceptual insights into the application of generalized multi-area dynamic equivalents to the analysis and study of the inter-area mode phenomenon in stressed power systems are provided. First, the notion of a Time-Varying, selective one-machine infinite-bus equivalent is briefly reviewed and details of the adopted analytical model are introduced.

A general nonlinear analysis technique based on Power Spectral Analysis is then proposed in which the equal-area criterion conditions are represented mathematically. Using this method, analytical estimates of the critical loading conditions are then derived that overcome many of the deficiencies of existing approaches. Various properties of the model such as the multi-swing instability conditions, and the nature and character of system oscillations in the aftermath of a critical contingency are established. Physical and mathematical conditions for the existence and stability of the limiting operating conditions are also given and simplifications of the model are analyzed.

On the basis of this representation, a mathematically rigorous method based on differential analysis to examine the Inter- Area Modes involved in the energy loss phenomena, is proposed to analyze the stability of large-scale complex systems. The method allows for the inclusion of inter-machine behavior and control effects in a systematic manner and results in a computationally efficient algorithm. The applicability of the proposed techniques is verified through simulation studies on several large-scale test power systems.

**Thesis Supervisor:** Dr. Carlos Juárez Toledo, Full Professor of UAEMex.

## Acronyms and symbols

Acronyms	Symbols	Definition
CM		Critical Machine
NC		No Critical Machine
CCT		Critical Clearing Time
DEEAC		Dynamic Extended Equal Area Criterion
EAC		Equal Area Criterion
EEAC		Extended Equal Area Criterion
COI		Center of Inertia
COA		Center of Angle
IAM		Inter-Area Mode
OMIB		One-machine Infinite Bus
PSS		Power System Stabilizers
SDT		Second Derivative Test
SIME		Single Machine Equivalent
SVC		Static VAR Control
TSAT		Transient Security Assessment Tool
TV-OMIB		Time-Varying One Machine Infinite Bus
	$A_{acc}$	Accelerating energy
	$A_{dec}$	Decelerating energy
	$\delta_{OMIB}$	OMIB angle
	$\omega_{OMIB}$	OMIB speed
	$P_{m_{OMIB}}$	Mechanical power OMIB
	$P_{e_{OMIB}}$	Electrical power OMIB
	$P_{a_{OMIB}}$	Accelerating power OMIB
	$M_{OMIB}$	Inertia coefficient
	$D_{OMIB}$	Damping coefficient

# General Index

Prologue.....	i
Abstract .....	ii
Acronyms and Symbols.....	iii
General Index .....	iv
Index of Figures.....	vi
Index of Tables .....	vii

## Chapter 1 Introduction

1.1 Problem Statement .....	1
1.2 Critique of Related Literature (State of the Art).....	2
1.2.1 The time-varying OMIB equivalent .....	2
1.2.2 Power Spectral Analysis.....	3
1.3 Objectives and contributions of the thesis .....	4
1.4 Structure of the thesis.....	5
1.5 References .....	6

## Chapter 2 Nonlinear Control of the Power System

2.1 Classification of OMIB-Based Methods .....	9
2.2 Generalized methods of reduction of power system .....	9
2.3 The TV- OMIB Equivalent .....	11
2.4 Time- Varying Damping Ratio.....	14
2.5 Fast Fourier Transform (FFT) .....	15
2.6 SVC Basic Theory .....	16
2.7 References .....	17

## Chapter 3 Frequency-Change Analysis of Nonlinear System Using Spectrum (Fast Fourier Transform) Theory

3.1 Nonlinear SMR.....	19
3.2 Numerical Results .....	23
3.3 Frequency-Change of Nonlinear System .....	27
3.4 References .....	28

## Chapter 4 Energy Loss Analysis of the Inter-Area Mode Using TV-OMIB Equivalent

4.1 The Case Study .....	30
4.2 Simulation Results.....	30
4.2.1 Base Case .....	31
4.2.2 Stressed System Condition .....	32
4.2.3 Effects of the SVC .....	33
4.3 Time- Varying Damping Ratio Results.....	34



4.4 Energy Loss Analysis Summary and Perspectives.....36  
4.5 References .....36

**Chapter 5 Conclusions**

5.1 General Conclusions .....37  
5.2 Recommendations for further works ..... 38

# Index of Figures

Figure 2.1 One-line diagram of the test system.....	10
Figure 2.2 Representation of a three-phase static VAR compensator (SVC) comprising fixed capacitors and thyristor-controlled reactors (TCRs) .....	16
Figure 3.1 Schematic representation of the CCI procedure, adapted from [M. Pavella et al., 1993].....	20
Figure 3.2 Dynamic behavior for rotor angle (a) and speed (b) corresponding to the Linear SMR .....	23
Figure 3.3 Comparison of machine dynamic behavior of rotor angle deviation (a) and speed deviation (b) corresponding to the linear and normal form model. The comparison between the figures obtained for the normal form and the figures obtained for the classical model shows the difference between both approximations. Fig. 3 shows this comparison .....	25
Figure 3.4 Comparison of machine dynamic behavior of rotor angle deviation (a) and speed deviation (b) corresponding to the linear and Taylor series expansion model.....	26
Figure 3.5 Comparison of machine states spectrum deviation: rotor angle (a) and speed (b) corresponding to the linear, Taylor series expansion and Normal Form models.....	27
Figure 4.1 Two Area, 4 Machine test System .....	30
Figure 4.2 Voltage Magnitude at Fault Bus .....	31
Figure 4.3 Fourier spectrum of the OMIB system Energy Loss ( $D_{OMIB} \omega_{OMIB}$ ) .....	31
Figure 4.4 Voltage Magnitude at Fault Bus (Heavy Stressed System) .....	32
Figure 4.5 Fourier spectra of both Inter-Area Mode Stressed Systems.....	33
Figure 4.6 Comparison of the Voltage Magnitude at Fault bus without SVC and with two different SVC gains .....	33
Figure 4.7 Comparison of the frequency spectra for the system without SVC and with two different SVC gains .....	34
Figure 4.8 Time- Varying Damping Rating at full scale.....	35
Figure 4.9 Time- Varying Damping Rating between 1.8 [s] and 2.2 [s].....	35

# Index of Tables

Table 3.1 Power Spectrum Comparison for the electromechanical signals of SMR ....	28
Table 4.1 Critical Clearing Time.....	32

# Chapter 1

## Introduction

### 1.1 Problem Statement

There are several OMIB equivalents. In most linear OMIB equivalents, the energy loss phenomena are dismissed and the system damping ratio with it, causing possible important data losses for the dynamic behavior of the system. The phenomena are represented by the Damping Ratio and the speed of the OMIB equivalent. In practice, the problem of finding the Damping Ratio ( $D_{OMIB}$ ) from a power system is complicated, mainly due to associated nonlinearities. This derives in the necessity of other methods and techniques, such as nonlinear analysis.

A nonlinear system behavior study needs a different methodology than the one used for linear approximations, because of the information losses due to the linearizing process. In this case the linear system approximation and the changes produced by the adding of nonlinear terms will be considered. This will provide information about the convenience or the importance that a complete model may have [1].

The necessity for improved modeling and analysis procedures in the study of nonlinear inter-area oscillations has been recently pointed out by several researchers [2–9]. Various approximations have been used in the modeling of nonlinear systems. Among them, the Method of Normal Forms (MNF) has been used to aid in the understanding of the fundamental nature of inter-area oscillations as well as to predict the onset of nonlinear behavior [10-12]. The method is particularly attractive for the study of nonlinear effects arising from the series expansion of the original nonlinear power system representation and is amenable to computer implementation [12-16].

Methods for the analysis of inter-area oscillations have been the subject of considerable research over many years [3, 17-19]. A simplifying assumption that is often used is that of linearity in the power system model and response. Such approaches have provided a good physical understanding of the Inter-Area Mode (IAM) phenomena [17], and have led to reliable methods to estimate the mode of instability and the corresponding critical machines. The main shortcoming of these approximations is the requirement of linearity that renders them invalid for many applications, especially for highly stressed systems subjected to severe disturbances. Further, ignoring the non-linear nature of the interaction between modes or oscillations disregards important information about power system dynamic behavior.

Among many non-parametric spectrum analysis methods, FFT is the most widely known and applied method. FFT is an algorithm to compute the Discrete Fourier Transform (DFT) of a discrete time series function with minimum computational effort [20]. This method will help us to find the deviation between the linear and the nonlinear equivalents and the Inter- Area Modes involved in the system energy loss phenomena [20-21].

## 1.2 Critique of Related Literature (State of the Art)

Linear control is a mature subject with a variety of powerful methods and a long history of successful industrial applications; however, an important assumption of linear control in power system is that the system model is indeed linearizable

In power system there are many non-linearities whose discontinuous nature does not allow linear approximation. These so called “hard nonlinearities” include Coulomb friction, saturation, dead-zones, backlash, hysteresis, etc.

Most of the early work on nonlinear system analysis methods for Perturbation analysis was based on effects of nonlinear second order on system dynamic behavior. In order to achieve this, nonlinear system analysis methods have to be used. Because such nonlinearities often cause undesirable behavior of the power system control, such as instabilities or spurious limit cycles, their effects must be predicted and properly compensated.

### 1.2.1 The time-varying OMIB equivalent

In this work Time-varying one-machine equivalent (TV-OMIB) identifies a second-order dynamic model of a system that preserves the essential dynamics of that system. Details of this type of models are given in [3, 18]; the basic concept is summarized here for completeness.

The main idea behind time-varying dynamic equivalents is to replace the post-disturbance dynamic behavior of a power system by a one-machine infinite bus equivalent. The transformation is local in nature and since the parameters of the equivalent are computed at each time step the resulting model is time-varying [22].

There may be other reasons to use TV-OMIB equivalent, such as cost and performance optimality. In power system setting ad-hoc extensions of TV-OMIB to control advanced machines with significant nonlinearities may result in unduly development periods.

Present computational and modeling capabilities allow the study of very large power system models. These achievements are possible by combining two technologies: the Extended Equal Area Criterion (EEAC) method and time domain simulations. Coupling of the EEAC with a commercial transient stability engine allows fast computation and accurate estimates of dynamic behavior. Examples of these formulations include FASTEST, SIME and the formulation presented in this work. These approaches have an intuitive appeal and perform satisfactorily in practical power systems. The development of time-varying based OMIB equivalent was motivated by several factors:

- Reduced-order dynamic descriptions that are inherently capable of capturing nonlinear structure are of great practical importance in an increasing variety of power system applications. The most successful algorithms for dynamic reduction of large-scale power system models have been OMIB-based approaches
- Most existing approaches are based on rather heuristic considerations, often resulting

from generalizations of the equal-area criterion. This limits their applicability to the study of first and second swing stability. The generalization of these approaches to multi-swing stability analysis is difficult and may result in large errors

- Recently, on line dynamic security tools have been developed to examine the nature of system behavior after critical contingencies. Among them, time-varying OMIB system has been successfully applied to determine the mode of instability [7]

More recent approaches for transient stability characterization have focused on the use of exact differential analysis. Nonlinear system analysis has been very successfully applied to particular classes of system and problems, contraction analysis was recently proposed to as a new time-frequency analysis tool for non-stationary signal.

### **1.2.2 Power Spectral Analysis**

The concepts of the unstable equilibrium point (UEP), the controlling UEP, and the potential energy boundary surface (PEBS) have been proposed to identify the critical generators. Once the critical generators have been determined, equal area based power system transient stability measures are used to analyze the onset of system instability.

The topic of Power Spectral Analysis for nonlinear analysis has attracted particular attention because, on one hand, the advent of powerful microprocessors has made the implementation of nonlinear analysis as relatively simple matter, and, on the other hand, modern technology, such as Phasor Measurement Unit (PMU), is demanding control system with more stringent design specifications.

Over the last few years, a number of energy loss studies have been developed and applied to large-scale power system models for transient stability assessment and control with varied success [17]. Much of the early work on energy loss identification for transient stability analysis was based on the use of Inter-Area Mode between relative rotor speed Time Varying OMIB deviations of generators losing stability and the subsequent transformation to a simpler system involving one or two machines.

These methods have proved useful for the visualization and extraction of a specific motion that is important for inter-system oscillations. More general situations, however, would demand the use of trajectory clustering techniques to derive dynamic measures of system stability [23].

In the study of complex system behavior, it is also of interest to study more localized system phenomena such as those arising from slow inter-cluster oscillations [24]. This information may be of interest to developing control strategies as well as to assess the influence of intelligent network control on overall system behavior.

The major weakness of analytical approaches appears to be their inadequacy to account for the complex inter-machine oscillations driven by nonlinear perturbations.

### 1.3 Objectives and contributions of the thesis

The purpose of this thesis is to provide models of machine reductions and control systems for performing transient stability analysis of power system, and for construction state variable model with small signal analysis. The dynamic reduction is coded as Time-Varying OMIB equivalent.

The main objective of this thesis is the development of modeling methodologies for the analysis of the energy loss phenomena in power systems. The proposed method involves some known tools of analysis such as the time variant OMIB equivalent. The purpose is to find a way to include nonlinear terms to a linear model. In order to achieve this, a small but appropriate study system is used. A numeric data base is used along with the study system in order to obtain some not-known OMIB terms which imply nonlinear dynamic behavior.

The original contributions of this research are summarized below

1. The development of a nonlinear methodology for the analysis of the system energy loss.
2. The introduction to nonlinear analysis using an equivalent model such as the TV-OMIB and the several considerations taken in order to find accurate results.
3. The introduction of the Fast Fourier Transform (Spectrum Theory) to analyze the Inter- Area Modes involved in the energy loss phenomena.

The list of papers written or co-written is below

- J. García G, C. Castillo L and C. J. Toledo “Frequency-Change Analysis of Nonlinear System Using Spectrum (FFT) Theory”, 6th International Conference on Electrical Engineering, Computing Science and Automatic Control, Toluca, México, 2009.
- J. García G., C. Castillo L., C. J. Toledo and I. Martínez C. “Energy Loss Analysis of the Inter-Area Mode Using TV-OMIB Equivalent”, 4to Congreso Iberoamericano de Estudiantes de Ingeniería Eléctrica (IV CIBELEC 2010) y 5tas Jornadas de Ingeniería Eléctrica (V JIELEC 2010), Mérida, Venezuela, 2010.
- C. Castillo L., I. Martínez C, C. J. Toledo y J. García G. “Modelo de Sistemas Eléctricos de Potencia (SEP’s) que Preservan su Estructura Usando la Teoría de Perturbación Singular”, 4to Congreso Iberoamericano de Estudiantes de Ingeniería Eléctrica (IV CIBELEC 2010) y 5tas Jornadas de Ingeniería Eléctrica (V JIELEC 2010), Mérida, Venezuela, 2010.

Paper being written to be sent to an International journal on September 2010.

- Energy Loss Damping of the Inter- Area Mode Using TV- OMIB Equivalent and FACTS controllers

Nonlinear analysis occupies and an increasingly conspicuous position in power system, as reflected by the ever-increasing number of papers reports on nonlinear analysis research and applications.

## 1.4 Structure of the thesis

This thesis is organized into five chapters.

After this introductory chapter, Chapter 2 provides the background for the specific analysis and design methods to be discussed in the later chapters; this chapter resumes the existent theory of OMIB and TV- OMIB equivalents and presents a review of the methods that had been used for these models. This is going to be the basis of the entire analysis. TV-OMIB equivalents are suitable to the non-linear analysis and its terms will be calculated in order to relate the system energy loss through other know system parameters.

Chapter 3 states the frequency change analysis of the nonlinear system using spectrum (Fast Fourier Transform) theory. Two different methods are used to include nonlinear terms. To check the validity of the Frequency-Change method, experiments were obtained using single-machine infinite-bus system using a classical representation. The purpose of these experiments is to find the phase difference between the classical model and the nonlinear equivalents.

Chapter 4 attends the energy loss analysis using a TV- OMIB equivalent. The analysis tool takes into account both, the dynamics of the slow inter-area oscillations and the dynamics of the fast inter-machine oscillations. A case study on a 2-area IEEE model in which a static VAR compensator is used to support system voltage is presented to illustrate the developed procedure. Studies are conducted to identify and characterize the energy transfer process that accompanies the inter-area mode separation as well as to evaluate the effect of voltage support on system damping. Spectrum (Fast Fourier Transform) Theory is used to check the system response and its frequency change. This introduces the concept of energy loss analysis using TV-OMIB equivalents and Fast Fourier Transform in order to find the Inter-Area Modes involved in the system losses. The results extend the existing formulations in three ways:

- (i) A stressed system is used to approximate the dynamic trajectory of the generalized TV-OMIB,
- (ii) The impact of the nonlinear terms on system dynamics are derived, and
- (iii) Compute damping due using the Static VAR Compensator

The above points are used to derive a dynamical model of the system with the ability to assess system stability.

In this thesis the developed procedure is tested on a 2-area, 4-generator dynamic equivalent model in which a static VAR source is used to enhance system dynamic performance.

Finally, a synthesis of the results and possible avenues for further research is provided in Chapter 5.



## 1.5 References

- [1]I. Martínez, A. R. Messina, E. Barocio. “Perturbation analysis of power: effects of second- and third – order nonlinear terms on system dynamic behavior”, *Electric Power Systems Research* 71 (2004) 159–167, Elsevier.
- [2]Y. Tamura, N. Yorino, “A generalized analysis method of auto-parametric resonances in power systems”, *IEEE Trans. Power Syst.* 4 (3) (1989) 1057–1064.
- [3]V. Vittal, N. Bhatia, A.A. Fouad, “Analysis of the inter-area mode phenomenon in power systems following large disturbances”, in: *Proceedings of the IEEE/PES 1991 Winter Meeting*, New York, USA, 1991, Paper 91 WM 228-7 PWRS.
- [4]J. Thapar, V. Vittal, W. Kliemann, A.A. Fouad, “Application of the normal form of vector fields to predict interarea separation in power systems”, *IEEE Trans. Power Syst.* 12 (2) (1997) 844–850.
- [5]C. M. Ling, V. Vittal, W. Kliemann, A.A. Fouad, “Investigation of modal interaction and its effects on control performance in stressed power systems using normal forms of vector fields”, *IEEE Trans. Power Syst.* 11 (2) (1996) 781–787.
- [6]G. Jang, V. Vittal, W. Kliemann, “Effect of nonlinear modal interaction on control performance: use of normal forms technique in control design. Part I. General theory and procedure”, *IEEE Trans. Power Syst.* 13 (2) (1998) 401–407.
- [7]M. Y. Vaiman, D. Sobajic, “A novel approach to compute characteristics of sustained interarea oscillations”, *IEEE Power Eng. Rev.* (January) (1998) 52–54.
- [8]E. Barocio, A.R. Messina, “Assessment of nonlinear modal interactions in stressed power systems with FACTS controllers”, in: *Proceedings of the 14th PSCC*, Sevilla, 24–28 June 2002, pp. 1–7.
- [9]A. R. Messina, E. Barocio, “Assessment of non-linear modal interaction in stressed power networks using the method of normal forms”, *Electrical Power Energy Syst.* 25 (2003) 21–29.
- [10]S. K. Starret, W. Kliemann, V. Vittal, A.A. Fouad, “Power system modal behavior: significance of second and third order nonlinear terms”, in: *Proceedings of the North American Power Symposium*, Washington, DC, October 1993.
- [11]B. Kahn, Y. Zarmi, “Nonlinear dynamics: a tutorial on the method of normal forms”, *Am. J. Phys.* 68 (10) (2000) 907–919.
- [12]V. I. Arnold, “*Geometrical Methods in the Theory of Ordinary Differential Equations*”, second ed., Springer Verlag, New York, 1988 (ISBN 0-387-96649-8).
- [13]F. Edneral, “A symbolic approximation of periodic solutions of the Henon–Heiles system by the normal form method”, *Math. Comput. Simulation* 45 (1998) 445–463.
- [14]A. H. Nayfeh, “*Method of Normal Forms*”, Wiley Series in Nonlinear Science, Wiley, New York, 1993 (ISBN 0-471-59354-0).
- [15]S. Wiggins, “Introduction to applied nonlinear dynamical systems and chaos”, in: *Text in Applied Mathematics*, vol. 2, Springer Verlag, New York, 1990 (ISBN 0-387-97003-7).
- [16]P. Kundur, “*Power System Stability and Control*”, EPRI Power System Engineering Series, McGraw-Hill, New York, 1998 (ISBN 0-07-035958-X).

- [17]C. Juarez T., A.R. Messina, D. Ruiz-Vega, “Analysis and Control of the inter-area mode phenomenon using selective One-machine Infinite Bus dynamic Equivalents”, *Electric Power Systems Research*, Volume 76, Issue 4, January 2006, Pages 180-193.
- [18]M. Pavella, “Generalized one-machine equivalents in transient stability studies”, *IEEE Power Engineering Review*, pp. 50-52, January 1998.
- [19]A. A. Fouad, V. Vittal, “Power System Transient Stability Analysis Using the transient Energy Function Method”, Prentice Hall ISBN 0-13-682675-X, pp 158-162, New Jersey, 1992.
- [20] J. W. Cooley, J. W. Tukey, “An algorithm for machine calculation of complex series”, *Mathematics of Computation Journal*, 19(90), 297-301, 1965.
- [21] Matlab Optimization Toolbox, User’s Guide, the Math Works Inc., Natick, MA, 1992.
- [22]J. García, C. Castillo, C. Juarez, “Frequency-Change Analysis of Nonlinear System Using Spectrum (Fast Fourier Transform) Theory”, CCE 2009, Toluca, Mexico, 2009
- [23]Gaffney, Scott, Padhraic Smyth, “Trajectory Clustering with mixtures of Regression Models”, *International Conference on Knowledge Discovery and Data Mining*, San Diego, California, United States, 1999. Pages: 63 – 72. ISBN:1-58113-143-7
- [24]M. Y. Vaiman, D. Sobajic, “A novel approach to compute characteristics of sustained interarea oscillations”, *IEEE Power Eng. Rev.* (January) (1998) 52–54.

# Nonlinear Control of the Power System

One-machine infinite bus equivalent is a powerful tool that allows the systematic analysis of power system transient stability. In recent years, a number of model reduction methods have been developed and applied to large-scale power system models with considerable success. These models are efficient for transient stability assessment of realistic power system models. However, many issues remain open with these methods, including the reliability of reduction techniques, the adaptability to change operating conditions, and the generation of reduced models for systems with multiple FACTS controllers.

In recent years, the availability of powerful low-cost microprocessors has spurred great advances in the theory and applications of nonlinear control of the power system.

- **In terms of theory**, major strides have been made in the areas of sliding control and nonlinear control of power system such as Fast Fourier Transform or Time varying OMIB equivalent.
- **In terms of applications**, many practical nonlinear theories have been developed, FACTS devices or phasor measurement unit.

As a result, the subject of nonlinear control occupies an increasingly important place in power system, and has become a necessary part of the fundamental background of control engineers.

The subject of nonlinear control in power system deals with the analysis and the design of nonlinear control system, i.e., of the control system containing at least one nonlinear state of machine component.

The objective of this chapter is to present various tools available for the analysis of the power systems nonlinearity. The study of these nonlinear analysis techniques is important for a number of reasons. Because theoretical analysis in power system is usually the least expensive way of exploring system parameters, simulation becomes very important in nonlinear control devices design.

The methods presented in this chapter can be used for nonlinear dynamic transient stability in power systems. One important application is the design of nonlinear control as SVC varying in time.

The chapter concentrates on nonlinear methods analysis in continuous-time form. Some tools, with particular emphasis in nonlinear transient stability in power system analysis are presented.

## 2.1 Classification of OMIB-Based Methods

Existing two-machine based dynamic equivalent approaches are motivated by the observation that follows a severe perturbation, the loss of stability of a multi-machine power system originates from the separation of its machines into two groups, the group of critical machines, and the non-disturbed group, or rest of the system [6].

In the OMIB equivalent, two important assumptions have been made. They are:

1. The machines in multi-machine power systems can be divided into two groups during transient stability analysis, and
2. The rotor angles and speeds of all machines in each group are equal to the values of partial centers of angles and speeds of each group

Having identified the critical groups, the system dynamic behavior is replaced by a one-machine infinite bus system and the stability margin is determined. Reduction techniques based on OMIB methods can be broadly categorized into two main categories [2].

1. Time-invariant formulations
2. Time varying and generalized methods

Time-invariant formulations are based on two simplifying assumptions:

- (i) simplified power system modeling, and
- (ii) the assumption of coherency within the machines in each group, so as to freeze their motion during the fault and post-fault conditions.

Among the most representative examples of this type of tools are the Extended Equal Area Criterion (EEAC) Approach developed by Y. Xue et al. [14].

The succeeding sections describe the properties of representations using Time varying and generalized methods. We also discuss the relationship between Single-Machine Equivalent (SIME) and the Equal Area criterion (EAC) to assess the stability of the OMIB. A more detailed account of these techniques may be found in reference [4, 14].

## 2.2 Generalized methods of reduction of power system

Consider the single-machine infinite-bus system shown in Fig. 1 adapted from [1]. In deriving the system equations, resistances are neglected and the generator is represented by a classical model as a constant voltage source behind a transient reactance.

The differential equations of motion of this system are thus

$$\frac{d\delta}{dt} = \omega \quad (1)$$

$$\frac{d\omega}{dt} = \frac{1}{2H} [T_m - T_e - D\omega] \quad (2)$$

where  $\omega$  is the angular velocity of the rotor in electrical rad/s,  $T_m$  is the mechanical input torque in p. u.,  $D$  is the generator damping coefficient in p.u. torque/p.u. speed, and  $H$  is the inertia constant in MWs/MVA.

A fundamental parameter of the Single Machine Representation (SMR) is the electric power,  $P_e$ :

$$P_e = \frac{E'E_b}{X_T} \sin\delta \quad (3)$$

where  $\delta$  is the angular position of the rotor in electrical radians with respect to the infinite system,  $E'$  is the voltage at the generator,  $E_b$  is the voltage at the infinite bus,  $X_T$  is the total reactance of the line and the transformer (Figure 1).

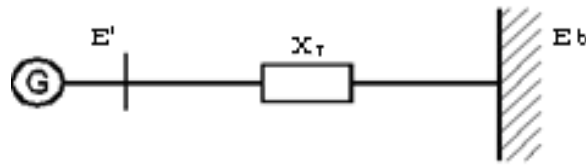

Fig. 2.1 One-line diagram of the test system

Starting the linearization about the operation initial condition represented by  $\delta = \delta_0$  yields the motion equations

$$\begin{aligned} \frac{d}{dt} \Delta\omega_r &= \frac{1}{2H} [P_m - P_e - D\Delta\omega_r] \\ \frac{d}{dt} \delta &= \omega_0 \Delta\omega_r \end{aligned} \quad (4)$$

where  $\omega_r$  is the relative angular velocity of the rotor and  $\omega_0$  is the reference angular synchronous velocity.

Linearizing eq. (4) and substituting  $\Delta P_e = P_{\max} \Delta\delta$ , we have

$$\frac{d}{dt} \Delta\omega_r = \frac{1}{2H} [\Delta P_m - P_{\max} \Delta\delta - D\Delta\omega_r] \quad (5)$$

where the maximum power is  $P_{\max} = \frac{E'E_b}{X_T}$  and the speed is  $\frac{d}{dt} \Delta\delta = \omega_0 \Delta\omega_r$ .

We assume that  $2H = M$ . Rewriting (4) and (5) in a matrix form results:

$$\frac{d}{dt} \begin{bmatrix} \Delta\delta \\ \Delta\omega_r \end{bmatrix} = \begin{bmatrix} 0 & \omega_0 \\ -\frac{P_{\max}}{M} & -\frac{D}{M} \end{bmatrix} \begin{bmatrix} \Delta\delta \\ \Delta\omega_r \end{bmatrix} + \begin{bmatrix} 0 \\ \frac{1}{M} \end{bmatrix} \Delta P_m \quad (6)$$

Equation (6) is the machine model. Solving the part of the system as function of the state variables through ode function of MATLAB [2, 3], the variations of  $\delta$  and  $\omega_r$  with time will be compared further with the nonlinear system approximations.

## 2.3 The TV- OMIB Equivalent

In this section, a brief review of the Single Machine Equivalent (SIME) method is given. The properties of the method are discussed and the developed technique is described.

### The SIME Method

The key aim of the SIME-based procedure is to replace the post-disturbance dynamic behavior of the power system by a local two-machine dynamic equivalent that represents the behavior of the critical (CM) and less critical (NC) machines: one describing the most disturbed machines, and the other describing the rest of the system. This is essentially accomplished by combining a transient stability program with the Extended Equal Area Criterion (EEAC).

Considering the SIME method, the position of the Center of Inertia (COI) of the critical (CM) group and the rest of the generators (NC) are:

#### Critical group

$$M_{CM} \ddot{\delta}_{CM} = \sum_{k \in CM} (P_{m_k} - P_{e_k}) \quad (7)$$

#### Rest of the system

$$M_{NC} \ddot{\delta}_{NC} = \sum_{l \in C} (P_{m_l} - P_{e_l}) \quad (8)$$

The computation of the time-varying OMIB equivalent involves, essentially, four main steps [4, 5]:

- 1) Starting with a given fault scenario, decompose the multi-machine system into two (or more) clusters of machines, namely the cluster of critical, most disturbed machines, (CM), and the remaining, non-critical (NC) machines.
- 2) Using the partial center of angle (COA) reference frame of each group [4], aggregate the machines of each cluster into an equivalent one.
- 3) A transformation is then used to represent the dynamic behavior of the two-machine equivalent system by an equivalent OMIB system in which the trajectory of the multi-machine system dynamics are fully replicated.
- 4) Assess transient stability of the OMIB using the EAC and determine other information of interest.

This approach uniquely identifies the key underlying dynamics of the system and can be extended to account for the internal dynamics to each group.

The identification of the CMs constitutes a critical step in the process. As noted above, SIME identifies the unstable condition using a time-domain transient stability program. At each step of the simulation, candidate decomposition patterns of CMs are considered by using the following three-step procedure [4]:

- a) Sort machines according to their rotor angle deviations,
- b) Identify the first largest rotor angular deviations, or distances, between adjacent machines, and
- c) Select candidate CMs according to their largest distances.

The procedure continues until a candidate group of CMs and the corresponding OMIB reaches the instability conditions [6].

## The OMIB Equivalent

In order to provide insight into the nature of this representation, let CM represent the group of most disturbed (critical) generators following a given perturbation. Using the nomenclature in [7], the position and speed of the center of angle (COA) of the critical group is given by

$$\delta_{CM} = \frac{1}{M_{CM}} \sum_{i \in CM} M_i \delta_i, \quad \omega_{CM} = \frac{1}{M_{CM}} \sum_{i \in CM} M_i \omega_i \quad (9)$$

The position and speed of the COA of the rest of generators  $NC$  is written similarly.

The equivalent electrical and mechanical power of the OMIB calculated by the time-domain, is described respectively by

$$\begin{aligned} P_{m_{OMIB}} &= M_{OMIB} \left( \frac{1}{M_{CM}} \sum_{i \in CM} P_{m_i} - \frac{1}{M_{NC}} \sum_{j \in NC} P_{m_j} \right), \\ P_{e_{OMIB}} &= M_{OMIB} \left( \frac{1}{M_{CM}} \sum_{i \in CM} P_{e_i} - \frac{1}{M_{NC}} \sum_{j \in NC} P_{e_j} \right) \end{aligned} \quad (10)$$

where the inertia coefficients are given by

$$\begin{aligned} M_{CM} &= \sum_{i \in CM} M_i; \quad M_{NC} = \sum_{j \in NC} M_j, \\ M_{OMIB} &= \frac{M_{CM} M_{NC}}{(M_{CM} + M_{NC})} \end{aligned}$$

From the previous definitions, it follows that the equation of motion of the OMIB can be expressed as

$$M_{OMIB} \ddot{\delta}_{OMIB} = M_{OMIB} \dot{\omega}_{OMIB} = P_{m_{OMIB}} - P_{e_{OMIB}} \quad (11)$$

or, equivalently,

$$\begin{bmatrix} \dot{\delta}_{OMIB} \\ \dot{\omega}_{OMIB} \end{bmatrix} = \begin{bmatrix} \omega_{OMIB} \\ \frac{1}{M_{OMIB}} (P_{m_{OMIB}} - P_{e_{OMIB}}) - \alpha_{OMIB} \omega_{OMIB} \end{bmatrix} \quad (12)$$

where  $\alpha_{OMIB}$  is the damping coefficient defined by  $\alpha_{OMIB} = D_{OMIB} / M_{OMIB}$ ;  $\delta_{OMIB} = \delta_{CM} - \delta_{NC}$  and  $\omega_{OMIB} = \omega_{CM} - \omega_{NC}$

Similar to the inertia case above, we can define the total damping of the OMIB as

$$D_{OMIB} = D_{CM} + D_{NC} \quad (13)$$

where  $D_{CM} = \sum_{i \in CM} D_i$ ;  $D_{NC} = \sum_{j \in NC} D_j$ .

Let the two-dimensional vector  $x_{OMIB}(t) = [x_1 \quad x_2]^T = [\delta_{OMIB}(t) \quad \omega_{OMIB}(t)]^T$ , the motion equations of the OMIB can be described by the two-dimensional nonlinear system

$$x_{OMIB}(t) = f(x) = \begin{bmatrix} f_1(x_1, x_2) \\ f_2(x_1, x_2) \end{bmatrix} \quad (14)$$

where

$$\begin{aligned} f_1(x_1, x_2) &= \omega_{OMIB} \\ f_2(x_1, x_2) &= \frac{1}{M_{OMIB}} (P_{m_{OMIB}} - P_{e_{OMIB}} - \alpha_{OMIB} \omega_{OMIB}) \end{aligned}$$

with associated equilibrium points

$$\begin{aligned} x_{OMIB}(t_0) &= [x_1^0 \quad x_2^0]^T = [\delta_{OMIB}(t_0) \quad \omega_{OMIB}(t_0)]^T \quad t = 0 \\ x_{OMIB}(t_i) &= [x_1^i \quad x_2^i]^T = [\delta_{OMIB}(t_i) \quad \omega_{OMIB}(t_i)]^T \quad t_i > 0 \end{aligned} \quad (15)$$

The initial condition of  $t=0$  is given by  $\dot{x}_{OMIB}(t)=0$  for any other point is necessary to determine the numerical solution using a commercial transient software.

With these definitions, the equation of motion of the OMIB can be expressed as

$$M_{OMIB} \ddot{\delta}_{OMIB} = M_{OMIB} \dot{\omega}_{OMIB} = P_{m_{OMIB}} - P_{e_{OMIB}} \quad (16)$$

or, in vector form

$$\begin{bmatrix} \dot{\delta}_{OMIB} \\ \dot{\omega}_{OMIB} \end{bmatrix} = \begin{bmatrix} \omega_{OMIB} \\ \frac{1}{M_{OMIB}} (P_{m_{OMIB}} - P_{e_{OMIB}}) - \alpha_{OMIB} \omega_{OMIB} \end{bmatrix} \quad (17)$$

Equation (17) describes a time-varying, of full system of the general form (11) whose parameters are updated at each time step of the transient stability simulation. Using path integration at a fixed time, the dynamic behavior of the system can then be characterized. This model forms the basis of Non-Linear OMIB of the subsequent sections.

Local stability properties are well described by small disturbance analysis, where the nonlinear system equations are linearized about the equilibrium point [8].

Conceptually, a fundamental simplification to the problem of the calculation of equivalent instantaneous it is obtained in this work when recognizing that the pattern  $P_{e_{OMIB}}$  in (12) can be considered as

$$P_{e_{OMIB}} = P_{\max_{OMIB}} * \sin(\delta_{OMIB}) \quad (18)$$

where  $P_{\max_{OMIB}} = M_{OMIB} \left( \frac{1}{M_{CM}} \sum_{i \in CM} P_{\max_i} - \frac{1}{M_{NC}} \sum_{j \in NC} P_{\max_j} \right)$  and the maximum power of each generator is  $P_{\max_i} = \frac{VT_i * E_i}{X' d_i}$

Using (18) in (17) the power series expansion around of  $\delta_{OMIB}$  and  $\omega_{OMIB}$  is:

$$\begin{bmatrix} \dot{\delta}_{OMIB} \\ \dot{\omega}_{OMIB} \end{bmatrix} = \begin{bmatrix} 0 & \omega_{OMIB} \\ -\frac{P_{\max_{OMIB}} * \cos(\delta_{OMIB})}{M_{OMIB}} & -\alpha_{OMIB} \end{bmatrix} \begin{bmatrix} \Delta \delta_{OMIB} \\ \Delta \omega_{OMIB} \end{bmatrix} \quad (19)$$

where  $\omega_{OMIB} = 2\pi f_{0_{OMIB}}$  and  $f_{0_{OMIB}}$  represents the frequency in the post fault point [7].

In what follows, we extend this description to include not only the dynamics of the two critical clusters of interest, but also to infer the energy transfer among the dominant mode(s) of oscillation



Time-Varying OMIB and generalized equivalents, on the other hand, offer the possibility to study system behavior more detailed, and some of these methods have the capacity for multi-swing analysis. The key aim of model reduction is to quantify system dynamic behavior using a detailed system representation.

Among these methods, the SIME method is particularly attractive for transient and mid-term stability assessment because SIME depicts the multi-machine system as one machine and shows the precise location of the critical cluster. It can be designed for real-time transient stability emergency control, by using real-time measurements.

In recent years several approaches to transient stability assessment have been developed and successfully applied to complex systems. Among them, the Transient Security Assessment tool (TSAT), and SIME remain the most valuable options.

## 2.4 Time- Varying Damping Ratio.

Dealing with nonlinear terms represents a significant problem. However, if some terms are known at every time step, nonlinear terms may be included numerically and compose a nonlinear analysis.

In practice, the problem of finding in power system the Time- Varying Damping Ratio of the OMIB equivalent ( $D_{OMIB}$ ) can be transformed into a threshold value problem [5, 10]. In this thesis, we use the notion of a loss energy function to derive an efficient algorithm.

Intuitively think of the function  $D_{OMIB}$  as indicating the loss energy in a stressed power system. In most linear OMIB equivalents, the energy loss phenomena is dismissed and the system damping ratio with it, causing possible important data losses for the dynamic behavior of the system. In order to avoid this problem, system energy loss is expressed in terms of other known OMIB parameters of the system. From (16), (17)

$$D_{OMIB}\omega_{OMIB} = P_{m_{OMIB}} - P_{e_{OMIB}} - M_{OMIB}\dot{\omega}_{OMIB} \quad (20)$$

Finally, to obtain the time- varying damping ratio ( $D_{OMIB}$ ),  $\omega_{OMIB}$  divides the right side of the equation and yields

$$D_{OMIB} = \frac{P_{m_{OMIB}} - P_{e_{OMIB}} - M_{OMIB}\dot{\omega}_{OMIB}}{\omega_{OMIB}} \quad (21)$$

This instant damping ratio is related with the TV- OMIB equivalent of the system and probably a constant. Due to many instant parameters and their values,  $D_{OMIB}$  will be calculated every time step with the specific conditions of the system at that time. It is important to notice that, as an equivalent, it may lose physical notion of the electric system components. However, it can give important information of the system. It also may show that system energy loss ( $D_{OMIB}\omega_{OMIB}$ ) has an important role in system dynamic behavior and its impact in nonlinear analysis.

Equation (21) has proved been useful for the visualization and extraction of experimental data for inter-system oscillations (Numerical algorithms and numerical results of equation (21) are discussed in Section 4.3). In the next section, we focus on the Fast Fourier Transform and SVC Basic Theory.

## 2.5 Fast Fourier Transform (FFT)

The FFT is extremely important in the area of frequency (spectrum) analysis because it takes a discrete signal in the time domain and transforms that signal into its discrete frequency domain representation. The FFT is a faster version of the Fourier Transform (FT).

The waveform may be described in the time domain or, with equal accuracy, in the frequency domain. The frequency domain graph have positive and negative frequency spectrum. When the FT is used for spectral analysis of time domain waveforms such as power system voltage and current waveform, the positive and negative frequency information from de FT will be identical. Thus, it is easier to consider all frequency spectrums as being purely positive.

According with the discussion on continuous convolution, the abstract use of FT on continuous waveforms involves integral calculus. However, the FT may be adapted for use on discrete time signals; as such it is referred to as the Fourier Transform FT.

Definition: Given a discrete set of real or complex numbers:  $x[n]$ ,  $n \in Z$  (integers), the FT of  $x[n]$  is usually written by [9, 12]:

$$X[\omega] = \sum_{n=-\infty}^{\infty} x[n] e^{-i\omega n} \quad (22)$$

The  $x[n]$  sequence can be the dynamic behavior for rotor angle and speed of machines as discussed in our numerical implementation of the method.

In practice, the FT, for transforming from time to frequency domains, is implemented as

$$X(f) = \int_{-\infty}^{\infty} x(t) \cdot e^{-i2\pi ft} dt \quad (23)$$

where  $f$  represents ordinary frequency (cycles per second) and the time discrete moment ( $t$ ) is depict using the  $n$  steps of (1) i.e.,  $t=nT$  with  $T$  is the sampling interval (in seconds).

Finally, FFT for  $D_{OMIB}\omega_{OMIB}$  is described by:

$$X(f) = \int_{-\infty}^{\infty} D_{OMIB}\omega_{OMIB}(t) \cdot e^{-i2\pi ft} dt \quad (24)$$

## 2.6 SVC Basic Theory

There are a lot of FACTS devices that can be introduced into power systems. Static VAR Compensators are the most commonly applied FACTS devices at present. They are based on the principle of parallel compensation and use fast thyristor controllers with a settling time of only a few periods [13]. The power controller can be realized in different manners: Thyristor Controlled Reactors (TCRs) are linearly controlled within an operating range of 90 to 180 degrees, whereas Thyristor Switched Reactors (TSRs) or Capacitors (TSCs) are fast switched elements and thus perform a stepwise control. Fixed capacitors or filters (FCs) complement the equipment and eliminate the undesired harmonics current components. SVCs contribute substantially to improve voltage quality in power systems. SVCs operate basically on voltage control by a given linear (TCR/FC) or stepped (TSR/TSC) V/I curve,

which is defined by the slop setting. This slop allows the SVC to properly coordinate for parallel operation with neighboring devices like generators, synchronous condensers or other FACTS equipment. The SVC in voltage control mode is the fastest thyristor controlled FACTS device with a settling time of only one period in case of TCR with FC. Figure 2 shows a schematic representation of the SVC.

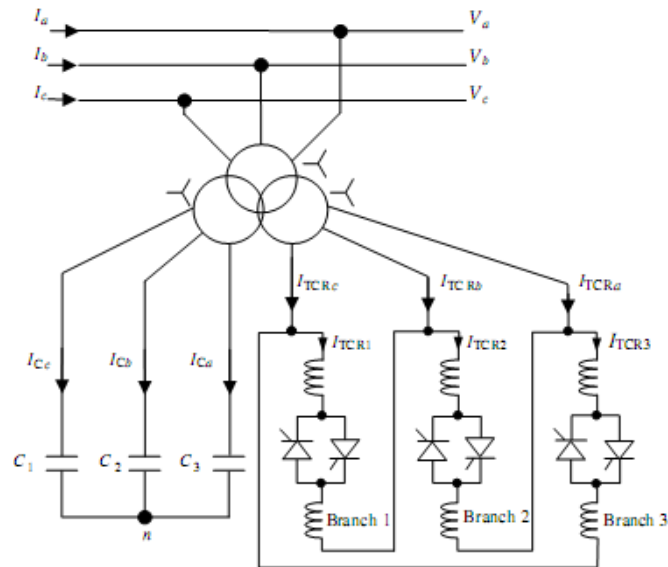

FIG. 2.2 Representation of a three-phase static VAR compensator (SVC) comprising fixed capacitors and thyristor-controlled reactors (TCRs)

Care must be taken in case of SVC applications under very weak system conditions. Effects of second harmonic instability and subsynchronous torsional interactions can lead to unacceptable system conditions with high harmonic or subharmonic voltage component. [13]

## 2.7 References

- [1]P. Kundur, “Power System Stability and Control”, EPRI Power System Engineering Series, McGraw-Hill, New York, 1998 (ISBN 0-07-035958-X).
- [2]Matlab Optimization Toolbox, User’s Guide, the Math Works Inc., Natick, MA, 1992.
- [3]J. W. Cooley, J. W. Tukey, “An algorithm for machine calculation of complex series”, *Mathematics of Computation Journal*, 19(90), 297-301, 1965.
- [4]M. Pavella, “Generalized one-machine equivalents in transient stability studies”, *IEEE Power Engineering Review*, pp. 50-52, January 1998.
- [5]C. Juarez, R. Castellanos, A. R. Messina, “Analysis of Inter-Area Oscillations using Time-Varying One-Machine Infinite Bus Equivalents”, *IEEE Power Engineering Society General Meeting*, San Francisco, California USA, 2005.
- [6]C. Juarez, A.M. Stankovic, “Contraction analysis of power system dynamics using time-varying OMIB equivalents”, “Las Cruces Nuevo Mexico” Sep, 2007 North American Power Symposium 2007, IEEE
- [7]I. Martínez, A. R. Messina, E. Barocio. “Perturbation analysis of power: effects of second- and third – order nonlinear terms on system dynamic behavior”, *Electric Power Systems Research* 71 (2004) 159–167, Elsevier.
- [8]S. Geeves, etal, “Improvement of system stability by the HARKER Static Var Compensators MC - Verification of System Performance by Digital and Real-Time Simulation”, in conference proceedings of ICPST’94, Beijing, China, Oct.18-21,1994
- [9]J. W. Cooley, J. W. Tukey, “An algorithm for machine calculation of complex series”, *Mathematics of Computation Journal*, 19(90), 297-301, 1965.
- [10]C. Juarez T., A.R. Messina, D. Ruiz-Vega, “Analysis and Control of the inter-area mode phenomenon using selective One-machine Infinite Bus dynamic Equivalents”, *Electric Power Systems Research*, Volume 76, Issue 4, January 2006, Pages 180-193
- [11]Glassman, J.A., “A Generalization of the Fast Fourier Transform”, *Computers, IEEE Transactions on Volume C-19, Issue 2, Feb. 1970 Page(s):105 - 116*
- [12]Dong Shen; Yingduo Han; Zhonghong Wang; Retzmann, D.; Povh, D., “Real time digital simulation studies for SVC controller”, *IEEE Power Engineering Review .Volume 1, 18-21 Aug. 1998 Page(s):406 - 410 vol. 1.*
- [13]Glassman, J. A., “A Generalization of the Fast Fourier Transform”, *Computers, IEEE Transactions on Volume C-19, Issue 2, Feb. 1970 Page(s):105 – 116.*
- [14] Xue, Y.; Rousseaux, P.; Gao, Z.; Belhomme, R.; Euxible, E.; Heilbronn, B., “Dynamic Extended Equal Area Criterion”; *Athens Power Tech, 1993. APT 93. Proceedings. Joint International Power Conference Volume: 2. Publication Year: 1993, Page(s): 889 - 895*

# Frequency-Change Analysis of Nonlinear System Using Spectrum (Fast Fourier Transform) Theory

Several recent large blackouts have occurred in some interconnection systems in many countries. All of them have caused terrible damages to national economy and population. At the same time, the undergoing harmonic content and large-scale usage of renewable energy have introduced more uncertainties and complexities to the system. As a result, modern power systems become more vulnerable to events that may trigger severe security problems.

The Fourier analysis is a decomposition of function or sequences in terms of their harmonic content. Thus far, we have considered the Fourier analysis of the Single machine Representation. In the next sections, we shall review some systematic procedures based on normal form (NF) theory are proposed for studying the influence of high order terms arising from the Taylor series expansion of the system model on power system dynamic behavior. Using this method, a second-order model of the power system is proposed in which weak system nonlinearities are explicitly represented. Analytical expressions are then developed that provide near approximate solutions to system performance.

The power spectrum possesses certain properties that are useful in understating the spectral representation. For example, the magnitude in the spectrum represents how important is the component of the signal, and the phase in the spectrum is the frequency change of the component in question. We will use the Fast Fourier Transform in the single Machine Representation to check the validity of the Frequency-Change method. Experiments were obtained using single-machine infinite-bus system using a classical representation. The purpose of these experiments is to find the phase difference between the classical model and the nonlinear equivalents.

In this chapter the need for more detailed nonlinear studies is exposed.

- Section 3.1 explains the concept of the Nonlinear Single Machine Representation with Normal Form theory and the Taylor Series expansion.
- Section 3.2 provides the numerical results to the Normal Form and Taylor Series developments.
- Finally in section 3.3 the Frequency Change Analysis is presented.

The methods of this chapter are used to show the impact of nonlinear terms in system stability, control and computing effort. Adding to this the Frequency- Change analysis, more and new evidence is presented in order to improve nonlinear analysis.

### 3.1 Nonlinear SMR

The Single Machine Linear Representation (SMR) is a hybrid, direct-temporal method for the analysis of large disturbance stability. SMR replaces at each time instant, the dynamics of a multi-machine power system by that of a suitable, time-varying One-machine infinite bus equivalent. By refreshing continuously the dynamics of the OMIB parameters, and by assessing the stability of the equivalent through Spectrum (Fast Fourier Transform) Theory, it is possible to accurately estimate stability margins and concentrate on the dynamics of interest. Since the method is applied directly to output data of a transient stability program, the technique allows the study of very complex systems. With the review of the Single Machine Linear Representation theory, two different nonlinear SMR's will be developed.

#### A. Identification of Critical Machines

As outlined in the introductory section, we wish to decompose the multi-machine system into two subsystems; the subsystem CM (Critical machines), and the subsystem NM (Not critical Machines). The two-machine equivalent system is further reduced to a single-machine-infinite-bus (OMIB) system model.

The unstable scenario is associated with the selection of the critical cluster; this fact makes the selection of the critical cluster very important for SIME method. At each time step, SIME determines the group of critical machines by identifying machines with largest relative rotor deviations. As pointed out in [2]:

*“More precisely, at each time step of the post-fault simulation, SIME sorts the machines according to their rotor angles identifies the very first larger rotor angular deviations (“distances”) between adjacent machines, and considers as candidate CMs those which are above each one of these larger distances... ”*. Several variations to this basic approach have been proposed in the literature. A slightly different approach is used in the FASTEST method [8].

In a multi-machine power system, transient stability phenomena are governed by its critical machines, i.e. those machines that are responsible for the irrevocable system separation whenever instability occurs [13].

More recently, the author extended this idea to allow the identification of several clusters of critical machines with the critical group which enables the study of inter-machine dynamics [9].

It is understood that the degree of criticality of a given machine is directly proportional to the magnitude of its rotor angle observed at ‘an appropriate instant of time’, in its evolution along ‘an appropriate trajectory’. The appropriate trajectory is a ‘near-critically cleared one’, i.e. cleared at a time somewhat above the actual CCT, and the appropriate observation time is the time able to reach the unstable equilibrium point of the corresponding OMIB.

- First find a candidate CC; obtain the corresponding OMIB equivalent; then, using the SEEAC, compute the relevant critical clearing angle  $\delta_c$ , and, hence, the unstable equilibrium angle  $\delta_u$
- With  $\delta_0$ , and  $\delta_c$ , known, solve a ‘global’ Taylor series. to find a candidate CCT  $t_c$ , which is possibly quite different and greater than the actual CCT

- Subdivide the during-fault time interval  $[0, t_c]$  into two equal parts to obtain  $t_c/2$ . Then compute  $\delta_i$  and its derivatives ( $\forall i=1,2,\dots,n$ ) at  $t_c/2$ , employing  $\delta_i$  and its derivatives evaluated at  $t_0 = 0$ ; this may be achieved by means either of ‘individual’ Taylor series [14] or of a step-by-step computation
- Compute likewise the individual machine angles at  $t$ , using the preceding interval values obtained at  $t_c/2$
- Knowing  $\delta_u$ , and  $\delta_c$ , use a global Taylor series to compute the time  $t_u$  required to reach the unstable equilibrium angle  $\delta_u$ , from  $\delta_c$
- Subdivide the post-fault time interval  $[t_c, t_c + t_u]$ ; into as many subintervals as deemed necessary. For illustrative purposes, the number of intervals considered in Fig. 2.1 is two

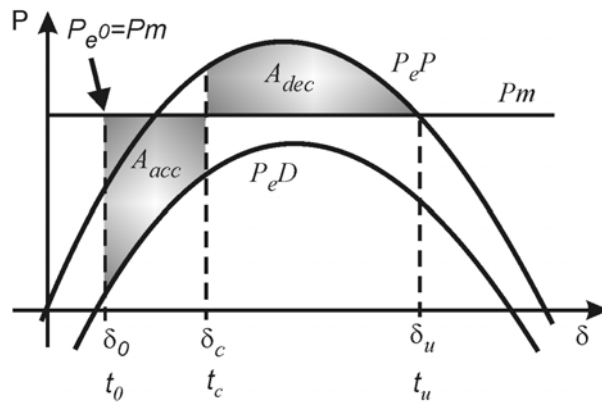

FIG. 3.1 Schematic representation of the CCI procedure, adapted from [M. Pavella et al., 1993]

### B. Nonlinear SMR using Normal Form

The first method is based on Normal Form theory and it was applied to a simple system [1] where the motion differential equations are:

$$\begin{aligned} \frac{d\delta}{dt} &= \omega \\ \frac{d\omega}{dt} &= \frac{1}{2H} [P_m - D\omega - P_{\max} \sin \delta] \end{aligned} \quad (21)$$

where  $P_m$  is the mechanical input power in p.u.

Introducing the two dimensional vector  $x = [x_1 \ x_2]^T = [\delta \ \omega]^T$ , the equation of motion can be described by the two dimensional nonlinear system

$$\dot{z} = f(x) = \begin{bmatrix} f_1(x_1, x_2) \\ f_2(x_1, x_2) \end{bmatrix} \quad (22)$$

where

$$f_1(x_1, x_2) = \omega \quad (23)$$

and

$$f_2(x_1, x_2) = \frac{1}{2H} [P_m - D\omega - P_{\max} \sin \delta] \quad (24)$$

with associated equilibrium points at  $(\sin^{-1}(P_m/P_{\max}) - k\pi, 0)$ , where  $k$  is any integer.

Let  $x_{\text{sep}} = [\delta^S \ 0]^T$  be a stable equilibrium point of interest. Expanding the nonlinear system in eq. (4) in a Taylor series up to order 3 about  $x_{\text{sep}}$  results in

$$\begin{aligned} \dot{z} &= Ax + f_2(x) + f_3(x) \\ &= Ax + \frac{1}{2} \begin{bmatrix} x^T H_2^1 x \\ x^T H_2^2 x \end{bmatrix} + \frac{1}{6} \begin{bmatrix} x^T H_3^1 \begin{bmatrix} x & \bar{0} \\ \bar{0} & x \end{bmatrix} x \\ x^T H_3^2 \begin{bmatrix} x & \bar{0} \\ \bar{0} & x \end{bmatrix} x \end{bmatrix} \end{aligned} \quad (25)$$

where matrix  $A$  (page 24) represents the linear part of the original vector field at  $x_{\text{sep}}$ ,  $0 = \text{zeros}[n \times 1]$ , and the variational matrices  $H_2^j$  y  $H_3^j$ ,  $j=1,2$  are defined by

$$\left\{ \begin{array}{l} H_2^1 = \begin{bmatrix} \frac{\partial^2 f_1}{\partial x_1^2} & \frac{\partial^2 f_1}{\partial x_1 \partial x_2} \\ \frac{\partial^2 f_1}{\partial x_2 \partial x_1} & \frac{\partial^2 f_1}{\partial x_2^2} \end{bmatrix} \\ H_2^2 = \begin{bmatrix} \frac{\partial^2 f_2}{\partial x_1^2} & \frac{\partial^2 f_2}{\partial x_1 \partial x_2} \\ \frac{\partial^2 f_2}{\partial x_2 \partial x_1} & \frac{\partial^2 f_2}{\partial x_2^2} \end{bmatrix} \end{array} \right\}_{|x=x_{\text{sep}}} ; \quad (26)$$

$$\left\{ \begin{array}{l} H_3^1 = \begin{bmatrix} \frac{\partial^3 f_1}{\partial x_1^3} & \frac{\partial^3 f_1}{\partial x_1^2 \partial x_2} & \frac{\partial^3 f_1}{\partial x_1 \partial x_2 \partial x_1} & \frac{\partial^3 f_1}{\partial x_2^3} \\ \frac{\partial^3 f_1}{\partial x_2 \partial x_1^2} & \frac{\partial^3 f_1}{\partial x_2 \partial x_1 \partial x_2} & \frac{\partial^3 f_1}{\partial x_2^2 \partial x_1} & \frac{\partial^3 f_1}{\partial x_2^3} \end{bmatrix} \\ H_3^2 = \begin{bmatrix} \frac{\partial^3 f_2}{\partial x_1^3} & \frac{\partial^3 f_2}{\partial x_1^2 \partial x_2} & \frac{\partial^3 f_2}{\partial x_1 \partial x_2 \partial x_1} & \frac{\partial^3 f_2}{\partial x_2^3} \\ \frac{\partial^3 f_2}{\partial x_2 \partial x_1^2} & \frac{\partial^3 f_2}{\partial x_2 \partial x_1 \partial x_2} & \frac{\partial^3 f_2}{\partial x_2^2 \partial x_1} & \frac{\partial^3 f_2}{\partial x_2^3} \end{bmatrix} \end{array} \right\}_{|x=x_{\text{sep}}} \quad (27)$$

### C. Nonlinear SMR using Taylor Series Expansion Method

If  $f(x)$  and its derivatives are continuous in an interval containing “a” (an equilibrium point) then the Taylor series expansion about that point is as follows [2]:



$$f(x) = f(a) + f'(x-a) + \frac{f''(a)}{2!}(x-a)^2 + \frac{f'''(a)}{3!}(x-a)^3 + \dots + \frac{f^n(a)}{n!}(x-a)^n \quad (28)$$

The Taylor series expansion for the sine function is:

$$\sin(x) = \sum_{n=0}^{\infty} \frac{(-1)^n}{(2n+1)!} x^{2n+1} = \frac{1}{1!}x - \frac{1}{3!}x^3 + \frac{1}{5!}x^5 \dots \quad (29)$$

This will be used to include high order nonlinear terms in the system.

Performing the expansion of the nonlinear part in the classical model of the machine, we can make a nonlinear approximation of the system adding the linear and nonlinear parts of the system; therefore, we can represent the behavior of the machine as [3]

$$\begin{aligned} \dot{\delta}(t) &= \omega(t) \\ \dot{\omega}(t) &= \frac{1}{M} [P_m - P_e(t) - D\omega(t)] \end{aligned} \quad (30)$$

where

$$\begin{aligned} P_m &= \text{constant} \\ P_e &= P_{\max} \sin(\delta) \\ \dot{\omega}(t) = \ddot{\delta}(t) &= \frac{1}{M} [P_m - P_{\max} \sin(\delta) - D\dot{\delta}(t)] \\ M \ddot{\delta}(t) &= P_m - P_{\max} \sin(\delta) - D\dot{\delta}(t) \\ \dot{\delta}(t) &= \omega(t) \\ \ddot{\delta}(t) &= \dot{\omega}(t) \end{aligned}$$

We can make a simplification of the system if we consider a particular case of a second order motion equation [4, 5]

$$\ddot{\delta}(t) + C(t)\dot{\delta}(t) + \alpha(t)\delta(t) + N(\delta, \omega) = u(t) \quad (31)$$

or, equivalently

$$\frac{d}{dt} \begin{bmatrix} \delta(t) \\ \omega(t) \end{bmatrix} = \begin{cases} \dot{\delta}(t) = \omega(t) \\ u(t) - C(t)\dot{\delta}(t) - \alpha(t)\delta(t) - N(\delta, \omega) \end{cases} \quad (32)$$

where  $N(\delta, \omega)$  represents the nonlinear part of the system.

Rearranging the terms as linear and nonlinear, the system (8) can be rewritten as

$$\frac{d}{dt} \begin{bmatrix} \delta(t) \\ \omega(t) \end{bmatrix} = J \begin{bmatrix} \Delta\delta \\ \Delta\omega \end{bmatrix} + \begin{bmatrix} 0 \\ h(\delta, \omega) \end{bmatrix} \quad (33)$$

where  $J$  represents the Jacobian matrix of the system,  $h$  represents the nonlinear part, from second order terms to high order terms.

#### ***D. Fast Fourier Transform of Nonlinear model SMR***

The FFT can vary dramatically depending on the number of points (N) of the FFT, and the number of periods of the signal that are represented.

Finally, FFT for  $\delta$  and  $\omega$  is described by:

$$X(f) = \int_{-\infty}^{\infty} \delta(t) \cdot e^{-i2\pi ft} dt \quad (34)$$

$$X(f) = \int_{-\infty}^{\infty} \omega(t) \cdot e^{-i2\pi ft} dt \quad (35)$$

respectively.

In this section, N was chosen as 4000, 50 Hz as the sampling frequency with a sampling time (T) of 0.02 seconds, and  $t=nT$  as the time discrete moment.

### 3.2 Numerical Results

We will take the synchronous machine as the main part of the system due to its states, and its nonlinear equivalent will have second order terms.

#### A. Single Machine Linear Representation results

As we can see in fig. 3a and 3b,  $\delta$  and  $\omega$  are equal in frequency. In this chapter the comparisons between lineal and non-linear methods are made for  $\delta$ , (In section 3.3 we will check the similarity between the frequencies of these signals).

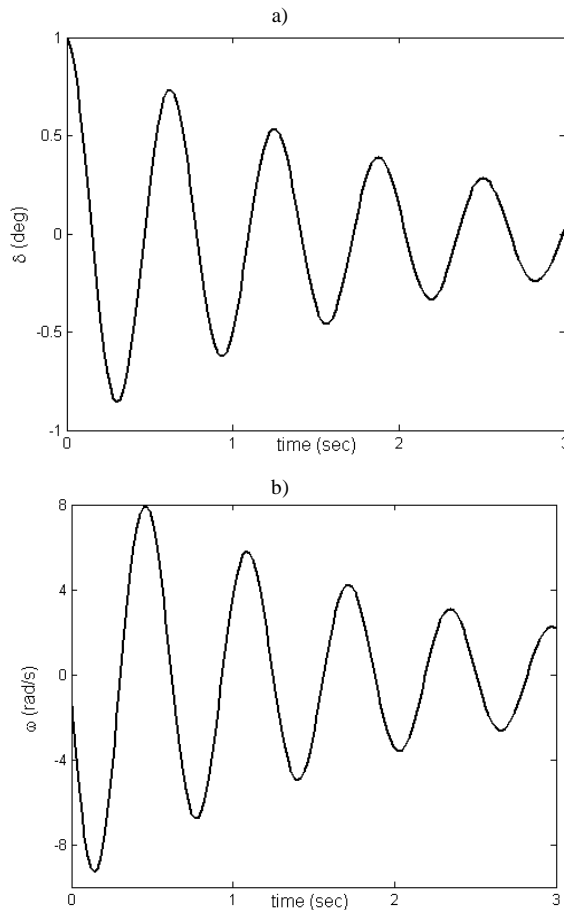

FIG. 3.2 Dynamic behavior for rotor angle (a) and speed (b) corresponding to the Linear SMR.

#### B. Normal Form Results

Assessment of transient stability using OMIB-based equivalents requires the identification of the critical machines involved in the oscillation. Once the OMIB is constructed, stability can be assessed by computing the excess of accelerating energy from the dynamic trajectory of the system

As discussed above the correct identification of the critical cluster and the rest of the system is critical to determine the OMIB parameters  $\delta, \omega, M, P_m, P_e, P_a$  and using the Single Machine Representation (SMR) of section IV, we will only consider the Taylor series expansion until the nonlinear second order terms. Thus the system will be as follows:

$$\begin{aligned} \dot{z} &= Ax + f_2(x) \\ &= Ax + \frac{1}{2} \begin{bmatrix} x^T H_2^1 x \\ x^T H_2^2 x \end{bmatrix} \end{aligned} \quad (36)$$

In order to obtain the nonlinear second order term matrix, we obtain the terms of each variational matrices:

$$\left\{ \begin{aligned} H_2^1 &= \begin{bmatrix} \frac{\partial^2 f_1}{\partial x_1^2} & \frac{\partial^2 f_1}{\partial x_1 \partial x_2} \\ \frac{\partial^2 f_1}{\partial x_2 \partial x_1} & \frac{\partial^2 f_1}{\partial x_2^2} \end{bmatrix}_{|x=x_{sep}} = \begin{bmatrix} 0 & 0 \\ 0 & 0 \end{bmatrix} \\ H_2^2 &= \begin{bmatrix} \frac{\partial^2 f_2}{\partial x_1^2} & \frac{\partial^2 f_2}{\partial x_1 \partial x_2} \\ \frac{\partial^2 f_2}{\partial x_2 \partial x_1} & \frac{\partial^2 f_2}{\partial x_2^2} \end{bmatrix}_{|x=x_{sep}} = \begin{bmatrix} \frac{P_{\max}}{M} \sin \delta & 0 \\ 0 & 0 \end{bmatrix} \end{aligned} \right. \quad (37)$$

where  $x_1 = \delta$  and  $x_2 = \omega$ .

Evaluating the nonlinear term matrix in a stable equilibrium point  $x = [\delta, 0]^T$ , we have

$$\left\{ \begin{aligned} \begin{bmatrix} x^T H_2^1 x \\ x^T H_2^2 x \end{bmatrix} &= \begin{bmatrix} 0 \\ \delta & 0 \end{bmatrix} \begin{bmatrix} \frac{P_{\max}}{M} \sin \delta & 0 \\ 0 & 0 \end{bmatrix} \begin{bmatrix} \delta \\ 0 \end{bmatrix} \\ &= \begin{bmatrix} 0 \\ \delta^2 \frac{P_{\max}}{M} \sin \delta \end{bmatrix} \end{aligned} \right. \quad (38)$$

Therefore, the system equation is

$$\begin{aligned} \dot{z} &= Ax + f_2(x) \\ z &= \begin{bmatrix} 0 & 1 \\ -\frac{P_{\max}}{M} & -\frac{D}{M} \end{bmatrix} \begin{bmatrix} \delta \\ \omega \end{bmatrix} + \frac{1}{2} \begin{bmatrix} 0 \\ \delta^2 \frac{P_{\max}}{M} \sin \delta \end{bmatrix} \end{aligned} \quad (39)$$

This equation will be solved through ode function of MATLAB [17].

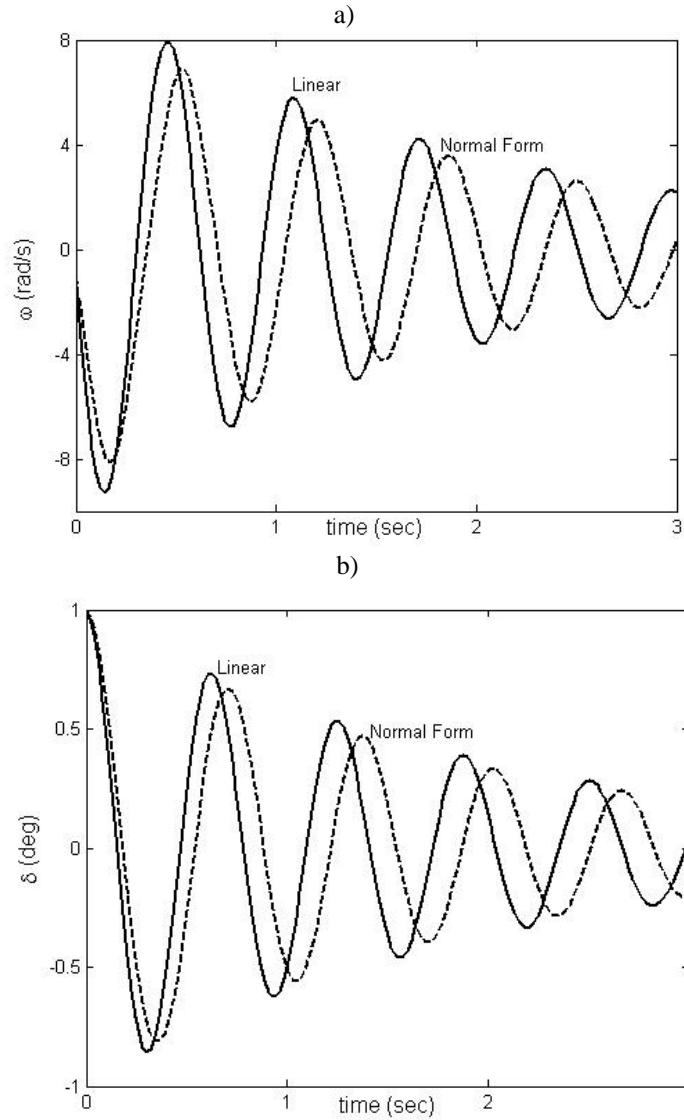

FIG. 3.3 Comparison of machine dynamic behavior of rotor angle deviation (a) and speed deviation (b) corresponding to the linear and normal form model.

The comparison between the figures obtained for the normal form and the figures obtained for the classical model shows the difference between both approximations. Fig. 4 shows this comparison

### C. Taylor Series Expansion

Considering the sine function expansion on (29), we can transform the mechanical input power as follows [4]:

$$P_{\max} \sin(\delta) = P_{\max} \left( \frac{1}{1!} \delta - \frac{1}{3!} \delta^3 \right) = P_{\max} \left( \delta - \frac{1}{6} \delta^3 \right) \quad (40)$$

Rewriting the machine model, adding the nonlinear terms, we obtain the nonlinear approximation equivalent:

$$\frac{d}{dt} \begin{bmatrix} \delta(t) \\ \omega(t) \end{bmatrix} = J \begin{bmatrix} \Delta\delta \\ \Delta\omega \end{bmatrix} + \begin{bmatrix} 0 \\ h(\delta, \omega) \end{bmatrix}$$

$$\frac{d}{dt} \begin{bmatrix} \delta(t) \\ \omega(t) \end{bmatrix} = \begin{bmatrix} 0 & 1 \\ -\frac{P_{\max}}{M} & -\frac{D}{M} \end{bmatrix} \begin{bmatrix} \delta \\ \omega \end{bmatrix} + \begin{bmatrix} 0 \\ -\frac{1}{6} \frac{P_{\max}}{M} \delta^3 \end{bmatrix} \quad (41)$$

As we did with the first method, this equation will be solved using an ode function of MATLAB. Once again, the next figures show the comparison between the figures obtained for the classical model and the ones for the Taylor series expansion method for  $\delta$  and  $\omega$  with time

Comparing the classic model variations for  $\delta$  and  $\omega$  fig.5 is obtained.

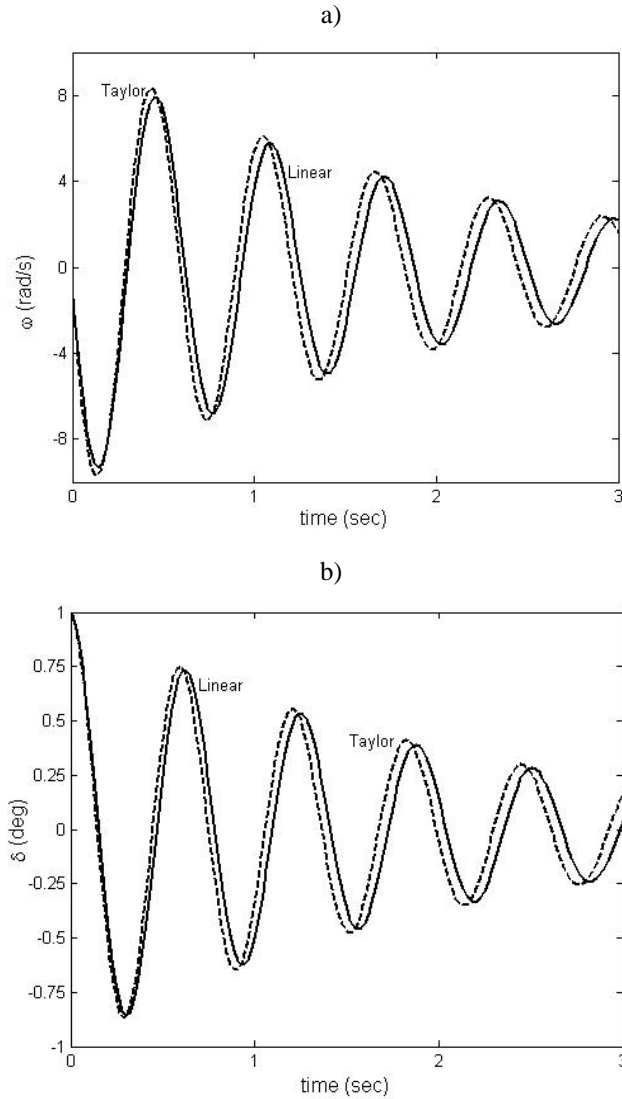

FIG. 3.4 Comparison of machine dynamic behavior of rotor angle deviation (a) and speed deviation (b) corresponding to the linear and Taylor series expansion model.

Figures 3 and 4 show the frequency-change between the non-linear methods with the linear method. In the next section we use FFT MATLAB function to check the frequency-change of these signals.

### 3.3 Frequency-Change of Nonlinear System

Finally we use the function FFT of MATLAB to find the frequency spectrum for the states of the SMR. The purpose of this last step is to find which nonlinear model is closer to the linear system in the frequency domain. In order to find this we use the FFT expressions from section IV.C. Figure 6 is a result from these expressions.

As we see in fig. 6 and Table 1, the three methods differ in the frequency analysis. However, there's a significant difference between the Normal Form method and the Taylor series expansion method.

Simulation results show that Taylor series is a better approximation with the linear representation of the machine. Unfortunately, the full solution of the system is not yet available to get a more accurate comparison of the nonlinear methods. The extension of the proposed methodology using to full solution is under development.

The frequency change of the nonlinear methods may be noticed better if a high order nonlinear term is included in the SMR.

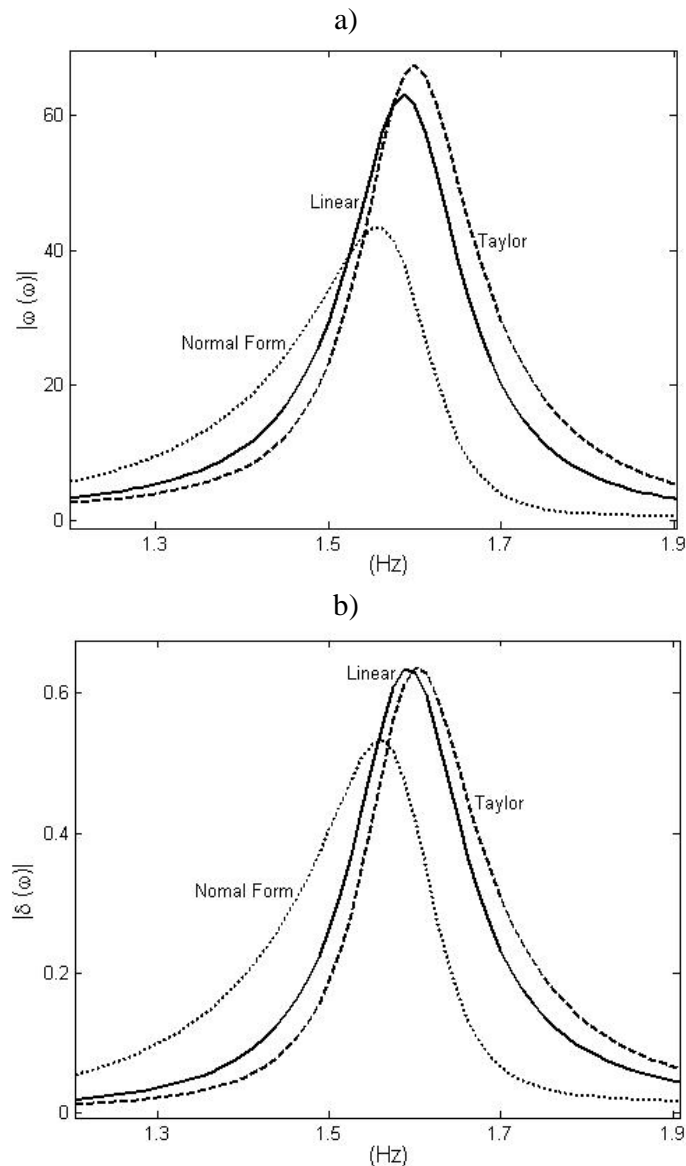

FIG. 3.5 Comparison of machine states spectrum deviation: rotor angle (a) and speed (b) corresponding to the linear, Taylor series expansion and Normal Form models.

Table 3.1: Power Spectrum Comparison for the electromechanical signals of SMR

	Peak of Power (Magnitude of FFT)	Frequency Value in the Power Peak (Hz)
<b>Angle</b>		
Linear	0.6346	1.5875
Taylor series	0.6364	1.6
Normal Form	0.5327	1.5625
<b>Speed</b>		
Linear	63.1608	1.5875
Taylor series	67.5955	1.6
Normal Form	43.2949	1.5625

### 3.4 References

- [1]I. Martínez, A. R. Messina, E. Barocio. “Perturbation analysis of power: effects of second- and third – order nonlinear terms on system dynamic behavior”, *Electric Power Systems Research* 71 (2004) 159–167, Elsevier.
- [2]J. W. Cooley, J. W. Tukey, “An algorithm for machine calculation of complex series”, *Mathematics of Computation Journal*, 19(90), 297-301, 1965.
- [3] C. Juarez T., A.R. Messina, D. Ruiz-Vega, “Analysis and Control of the inter-area mode phenomenon using selective One-machine Infinite Bus dynamic Equivalents”, *Electric Power Systems Research*, Volume 76, Issue 4, January 2006, Pages 180-193
- [4]C. Juarez, R. Castellanos, A. R. Messina, “Analysis of Inter-Area Oscillations using Time-Varying One-Machine Infinite Bus Equivalents”, *IEEE Power Engineering Society General Meeting*, San Francisco, California USA, 2005.
- [5] Glassman, J.A., “A Generalization of the Fast Fourier Transform”, *Computers, IEEE Transactions on* Volume C-19, Issue 2, Feb. 1970 Page(s):105 - 116

# Energy Loss Analysis of the Inter-Area Mode Using TV-OMIB Equivalent

In recent years, computational intelligence and machine learning techniques have gained popularity to facilitate very fast dynamic security assessment for enhanced situational awareness of insecurity. However, many of the current stability analysis of the Inter Area Mode (IAM) usually suffer from excessive training time and complex parameters tuning problems, leading to inefficiency for real-time implementation and on-line model updating.

In this chapter, a Time Varying OMIB Equivalent using the increasingly prevalent Fast Fourier Transforms is proposed. It has significantly improved the learning speed and can therefore enable effective on-line updating. The proposed model is examined on the 2-area with 4-machine dynamic equivalent of the IEEE, simulation results show that the proposed model possesses significant superior computation speed and comparable high prediction accuracy of the IAM behavior.

New insights into the application of One-Machine Infinite Bus (OMIB) equivalents to the analysis and study of the inter-area mode phenomenon in stressed power systems are provided. The analysis tool takes into account both, the dynamics of the slow inter-area oscillations and the dynamics of the fast inter-machine oscillations. A case study on a 2-area IEEE model in which a static VAR compensator is used to support system voltage is presented to illustrate the developed procedure. Studies are conducted to identify and characterize the energy transfer process that accompanies the inter-area mode separation as well as to evaluate the effect of voltage support on system damping. Spectrum (Fast Fourier Transform) Theory is used to check the system response and its frequency change.

Faithful extraction and representation of the Spectrum simulation allows the identification of the dominant mode of separation, the critical machines involved in the oscillation(s), and the energy exchange between modes or oscillations [1].

The objective of this chapter is to present a numerical approximation to the energy loss in the Inter- Area mode of the nonlinear power system. The study of this energy loss is important for a number of reasons. Because linear analysis in power system is usually the least expensive way of exploring system characterizes, and simulation although it dismisses some important terms such as the energy loss. The importance of these nonlinear terms is to be considered due its impact in system dynamics and control.

The chapter falls into two parts. In the first part, the application of the technique to determine the nature of the Case Study is presented. In the second part, control-based techniques are used to enhance the damping of this system.



## 4.1 The Case Study

Simulation studies were conducted on a 2-area, 4-machine dynamic equivalent from the IEEE, shown in Figure 2. This system has been the basis for many case studies on Power System stability analysis and other applications.

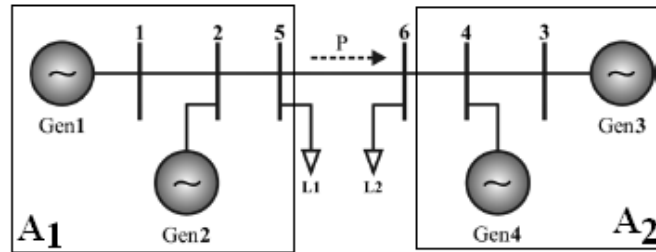

FIG. 4.1 Two Area, 4 Machine test System

The Two Area, 4 Machine test System has the next three modes:

- The first important mode is the two inter- area mode 1 that involves the interaction of machines in the Area 1 (machines 1 and 2) swing against the Area 2 (machines 3 and 4).
- Further, the system exhibits a second critical Local mode at Area 1 in which machine 1 swing in opposition to machine 2
- The third important Local mode is the Area 2 which involves machine 3 swinging mainly against machine 4.

The other modes essentially represent localized phenomena associated with the interaction of geographically close machines.

An SVC, connected to bus 3, will be used to enhance system dynamic performance.

The main idea of the case study is to find the impact of the nonlinear terms on system dynamics, specifically on energy loss of the Inter Area Mode and their damping due to the action of the Static VAR Compensator.

A stub three-phase short circuit at bus 3 with subsequent clearing is used to stress the system in order to find involved critical Inter-Area Modes.

The 2-area system is reduced to a TV-OMIB equivalent to obtain the OMIB parameters. It is important to notice that the only unknown parameter will be the system energy loss ( $\alpha_{OMIB} \omega_{OMIB} = D_{OMIB} \omega_{OMIB}$ ).

Fast Fourier Transform is used to find the frequency spectrum of this energy loss. Inter-Area Modes are expected in this final analysis and system enhancement through SVC will be used to witness the damping of the involved modes.

## 4.2 Simulation Results

The Frequency theory technique is tested on a 2-area dynamic model of the IEEE system representing the synchronous operation of two interconnected regional systems. The system model consists of 6 buses, 9 branches, 1 static VAR compensator and 4 machines represented in detail including exciters and PSSs.

A single line diagram of this system indicating major transmission facilities is shown in Figure 1.

### 4.2.1 Base Case

First, a base case is simulated. This system has no SVC connected and stays stabilized after the fault. Figure 2 shows the voltage magnitude at fault bus.

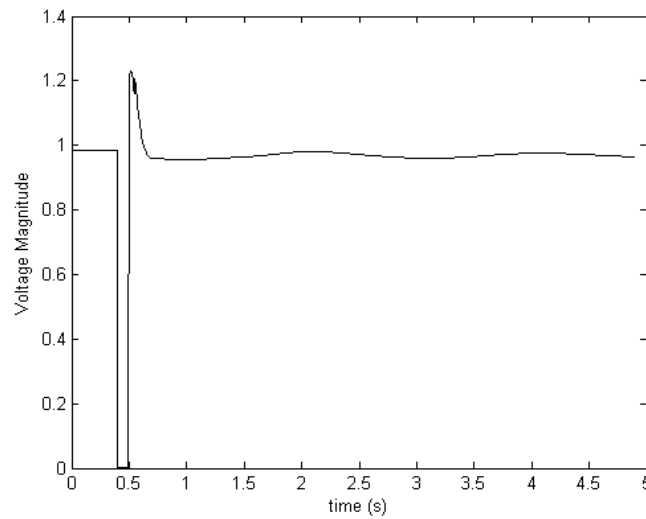

FIG. 4.2 Voltage Magnitude at Fault Bus

Further, applying the described procedure, Fourier spectrum of the energy loss shows the inter-area mode involved after the fault, as is shown in Figure 3.

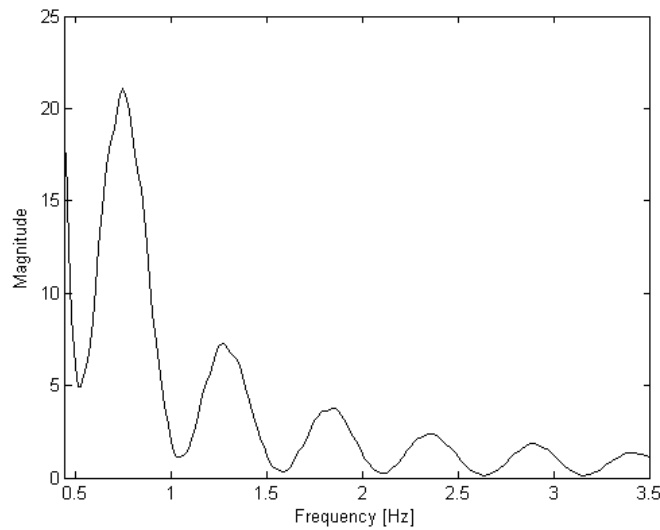

FIG. 4.3 Fourier spectrum of the OMIB system Energy Loss ( $D_{OMIB} \omega_{OMIB}$ )

It's important to notice that figure 3 states the existence of OMIB system energy loss. Regularly, this term is neglected for linear studies because the electrical power ( $P_e$ ) is considered more much bigger than  $D\omega$ . The procedure developed in this study reveals that this term is of great significance in non- linear dynamics.

Figure 3 also shows inter- area modes involved in the phenomena. Inter- Area mode 1 between A1 and A2 of Figure 1 interface is the most involved mode in this case and it can be noticed due to its magnitude and frequency.

## 4.2.2 Stressed System Condition

A heavier stressed system is going to be used. The same simulation runs with a different fault clearing time. Table I. shows the clearing time for the different cases.

**Table 4.1**  
Critical Clearing Time

Case	Fault Clearing Time [s]
Base Case	0.1
Stressed System Condition	0.15

Figure 4 shows the new voltage magnitude for the fault bus.

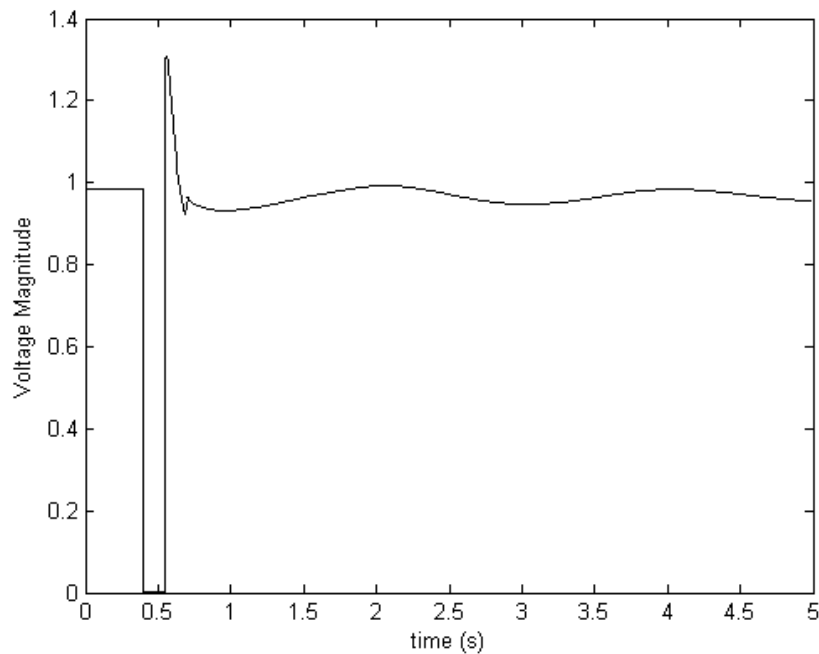

FIG. 4.4 Voltage Magnitude at Fault Bus (Heavy Stressed System)

Figure 6 shows the comparison between both simulations and the magnitude difference in the frequency spectrum. There is significant difference between both simulations as in magnitude as in frequency. The frequency spectrum shows that there is a frequency-change between the stable system and the stressed system which is at the border of stability.

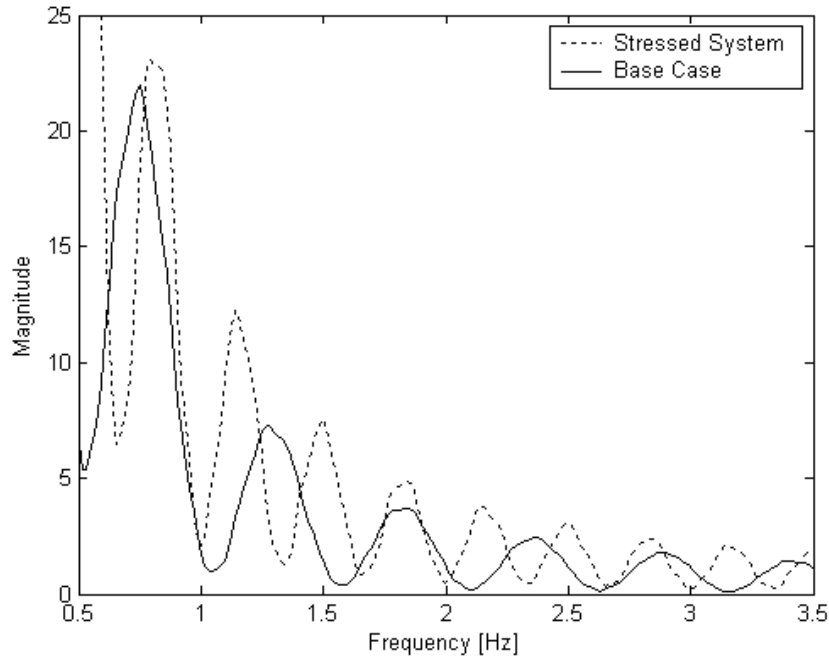

FIG. 4.5 Fourier spectra of both Inter-Area Mode Stressed Systems

### 4.2.3 Effects of the SVC

The next step consists on damping this energy loss with a SVC, connected to bus 3. Experiments were obtained with different SVC gains, trying to enhance the system dynamic performance. Figure 7 shows the comparison between the system without SVC, the system with a SVC gain of 25% and the system with a SVC gain of 100%. The oscillations after the fault are damped by the action of the SVC and, as higher its gain, as higher the damping.

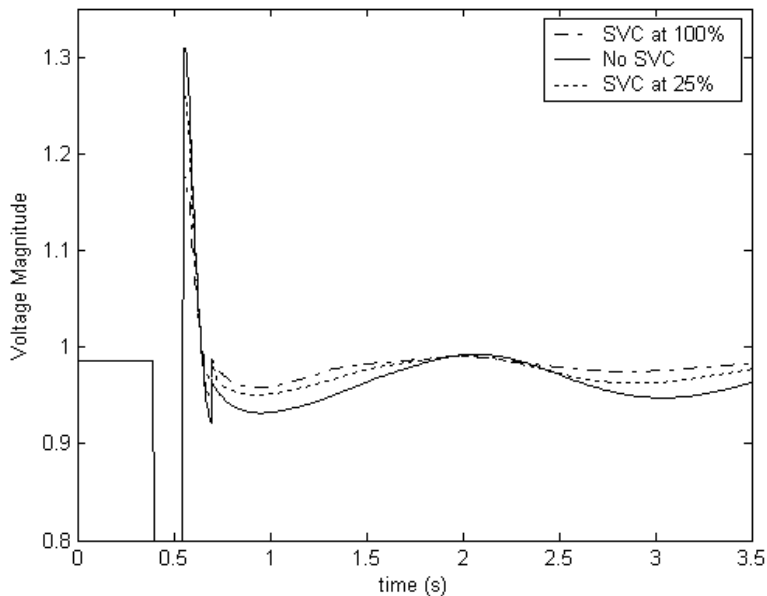

FIG. 4.6 Comparison of the Voltage Magnitude at Fault bus without SVC and with two different SVC gains.

Finally, system frequency spectrum is compared for the three proposed cases in figure 7. It is clear that the damping action of the SVC over the inter-area mode of the OMIB gets higher with its gain. The frequency analysis of energy and OMIB speed in Fig.

6, on the other hand, confirms that SVC voltage support at Line 5-6 on the inter-area mode 1 between A1 and A2 of Figure 2 interface has a decisive effect in this mode.

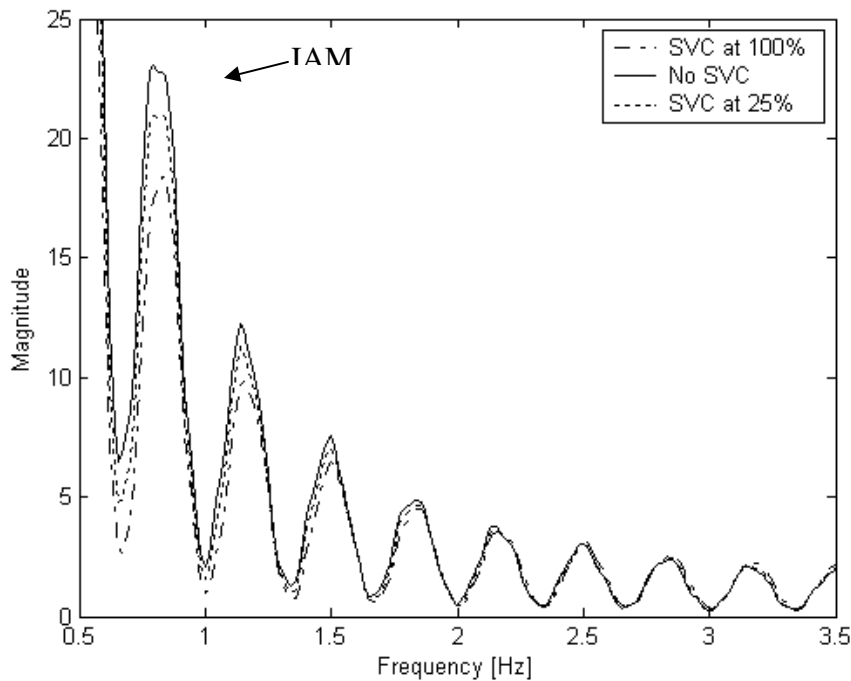

FIG. 4.7 Comparison of the frequency spectra for the system without SVC and with two different SVC gains.

### 4.3 Time- Varying Damping Ratio Results

From (21), a numeric solution is used to obtain the time- varying damping ratio. It is important to notice that its magnitude presents high values possibly because numeric mistakes. In order to ease the interpretation of these results, a maximum gain for the SVC was pursued and found. Although a 100% SVC gain presented good results for voltage magnitude and inter- area mode magnitude damping, simulations showed that this gain caused system stress and a minor damping ratio, even against a system without SVC. A 42% gain showed to be the best value for damping ratio purposes. This value was used to normalize and present the result information. The results for the time- varying damping ratio are shown in fig. 8 (full scale) and fig. 9 (zoomed data).

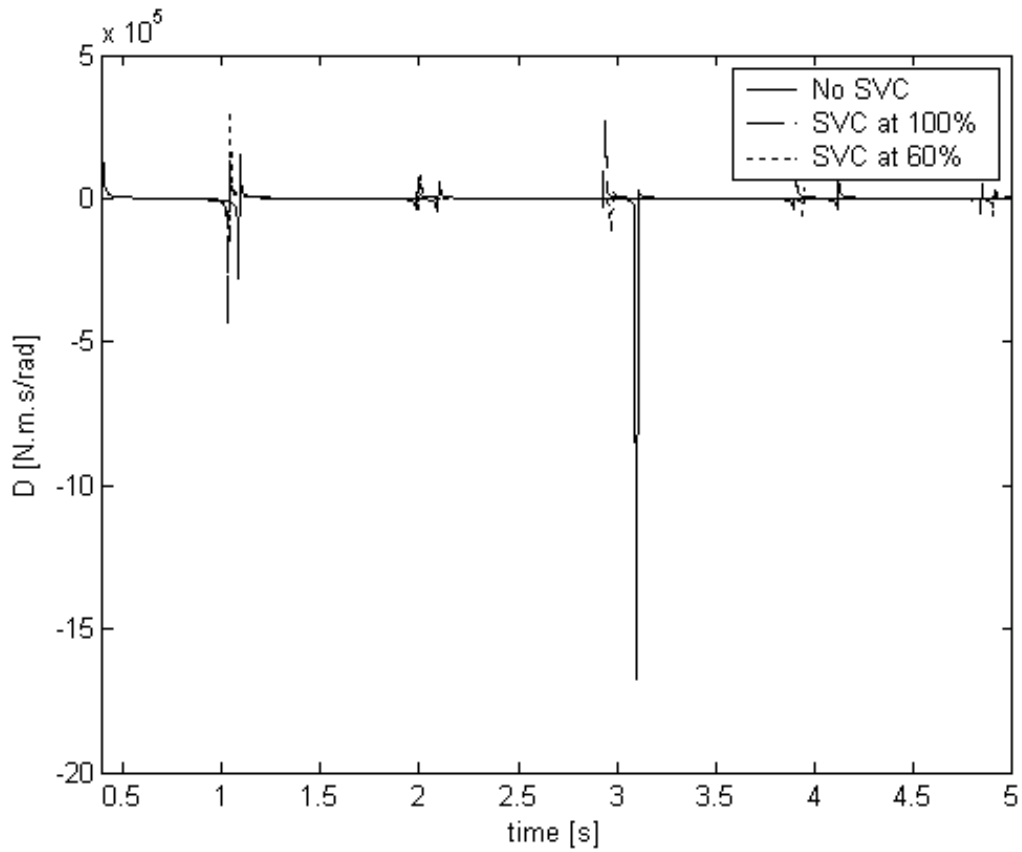

FIG. 4.8 Time- Varying Damping Ratio at full scale

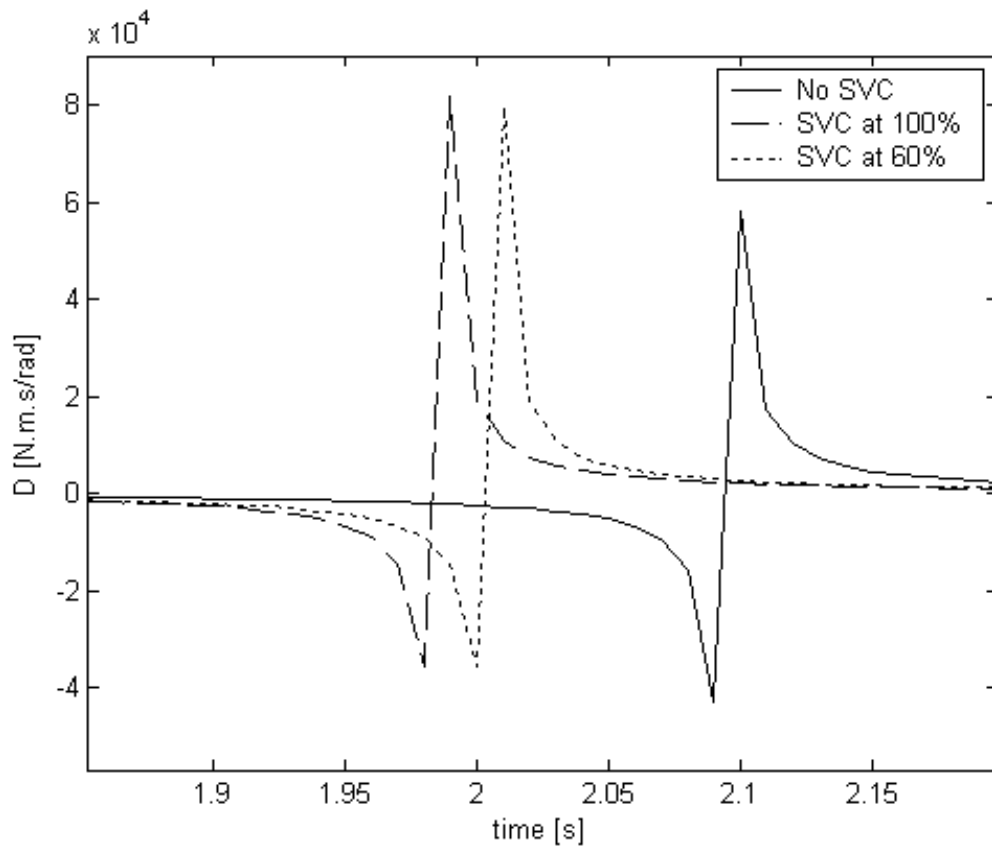

FIG. 4.9 Time- Varying Damping Ratio between 1.8 [s] and 2.2 [s]

#### 4.4 Energy Loss Analysis Summary and Perspectives

In this chapter, we explored some extensions to existing approaches, which can be used to selectively derive approximated Damping OMIB equivalents as well as to assess the effect of controllers on system damping. The objective was to extract the key underlying dynamics of the process giving rise to the IAM phenomenon, and the development of remedial measures based on the use of control devices.

First of all, the existence energy loss is stated. Considered as a neglected term in the OMIB equivalent for many studies, the Energy Loss phenomena may have an important impact on system dynamic behavior, especially for nonlinear studies. This is directly related with the inter- area modes of the power system. After this statement, the IAM phenomenon of two different stressed systems is shown and the effects of SVC control clearly have an important damping effect over the system energy loss phenomena. Inter- area Mode 1 presents an important damping ratio compared with other inter- area modes. This damping ratio decreases for less important inter- area modes. The use of SVC controls to analyze the Damping OMIB following large disturbances has been recently proposed for on-line control and assessment of transient oscillations in the context of the TV-OMIB Equivalent. In dealing with large-scale stressed power systems characterized by several lightly damped low-frequency oscillatory modes, however, direct compression of the system multi-machine dynamics into an OMIB equivalent may preclude the analysis of inter-machine dynamics associated with the nonlinear interactions among different areas or generators.

As seen on the last part of this chapter, associated nonlinearities with the Energy Loss phenomena and the Damping Ratio of the Time- Varying OMIB equivalent and numerical mistakes cause some severe changes through the simulation time. However, important information from the system is obtained in stable periods of the analysis. These approaches provide a more physical interpretation of the key system dynamic behavior and enable a more precise definition of post-disturbance inter-area oscillations in comparison to current small-signal analysis methodologies.

In addition, it may be necessary to analyze the influence of major control devices on system damping or evaluate transient stability limits across major interconnections. This is particularly true in power systems with embedded FACTS controllers located at strategic locations between major areas or groups of generators.

## 4.5 References

[1]J. García, C. Castillo, C. Juárez, “Frequency-Change Analysis of Nonlinear System Using Spectrum (Fast Fourier Transform) Theory”, CCE 2009, Toluca, Mexico, 2009.

#### 5.1 General Conclusions

Two different methods are used to include nonlinear terms in chapter 3. To check the validity of the Frequency-Change method, experiments were obtained using single-machine infinite-bus system using a classical representation.

Figure 6 shows that the Taylor series is a better approximation of linear system than the Normal Form method. The linear system is the reference; however it is important to notice that it is necessary to check these results with a more complex model (full solution), to obtain better comparisons of the nonlinear methods.

In chapter 4, a Fast Fourier Transform Energy Loss Analysis was performed over a 2-area, 4 generator system. Results showed that there is an inter-area mode involved in system energy loss and that it can be damped by a control action, such as static VAR compensation. This study also shows that linear OMIB equivalents present an error considering that system energy loss is equal to zero. Further experiments and analysis are needed over this matter because the several data losses due to the dismissed nonlinear terms.

Small signal analysis is the key to obtain the results shown in this work, specifically chapter 4. Introducing nonlinear terms numerically and managing the model with small signal analysis, system stability and dynamic behavior is procured. Finally, Fast Fourier Transform allows identification of inter-area modes participating in the energy loss phenomena. The larger in magnitude, the relevance they will have in system characteristics.

Some of the advantages of the developed methodology are listed below:

- Perform nonlinear energy loss analysis without data losses.
- Determine the inter-area modes involved in the phenomena and their relevance
- Using the TV- OMIB equivalent, it's is possible to establish the dynamic behavior of the system through time.
- Select actions that contribute to the analysis, control and damping of the system.

The limitations of the methodology are:

- Larger nonlinear studies are needed in order to validate the method
- Only voltage support was performed during experiments.
- The proposed methodology is based on numerical methods, so the results depend directly on the accuracy of the data.



## **5.2 Recommendations for further works**

The next topics of investigation are proposed

- Using TV- OMIB equivalents, perform a larger study to validate the proposed methodology
- Perform different control actions. In this work, only static VAR compensation was performed on the system.
- Use the TV- OMIB parameters to evaluate transient stability and determine suitable control measures.